



FRIZKON
INTERNATIONAL

Ophthalmic Instruments



www.frizkontools.com

info@frizkontools.com



Eye Surgery
Augen-Instrumentarium
Oftalmologia
Chirurgie ophtalmologique
Oftalmologia



FRIZKON TOOLS

Established in 2006 **FRIZKON TOOLS** provides premium solutions for exceptional value to individuals and businesses. We are the third generation Ophthalmic, Electro Surgical and Plastic Surgery Instruments manufacturing company. Frizkon portfolio encompasses an experience of over 15 years to introduce technological advancements through wide range of product, we gather our strength from creative thought processing, strategic marketing techniques and experience of a team of individuals talented by nature and trained by the profession.

Position ourselves to be regional players of quality making products, improve on contemporary measure including cost, quality, service, speed of delivery and mobilization. We are customer driven we go the extra mile to make sure our clients exceptions are met and exceeded on every issue. Experience has shown that most clients prefer to work with our company rather than having many suppliers / companies. To achieve this, Frizkon have brought all your technological needs under one roof, we make sure that all our processes and methods conform to the highest ideals of professional behavior.

The commitment to excellence make us a world class well known company for our high quality standards from design to finished products and from sales to shipment all procedures and processes are organized to give our customers reliable products and a convenient and punctual services.

After years of expertise and experience, we still remain dedicated to continuous business and personal development, building strong customer relations and investing in research and development, Innovative ideas and personal dedication combined with high quality products is our specialty, our commitment of introducing quality products combined with honest, reliable service has proven to be a successful theory in ensuring the continued rapid growth of the company. Our transparent business policies together with highly professional and values are sheet anchor of our company management.

FEATURES OF OUR QUALITY CONTROL PROCEDURES



1:- MATERIALS

Choosing material is the main factor in the manufacturing process normally best kind of stain less is used in manufacturing the items, but other kind of French and Japanese steel and a series of 300 / 410 and 420 are also used as per the customer requirements. PQA is the competent authority for the testing of raw materials, A rigid quality control policy is being adopted before releasing to the production process. Material test is to check the standard of steel as per desired specification and requirement of the customers.

2:- FORGING AND HAMMERING

Hot and cold forging is performed to the raw material (stainless steel bars) for the standard press operations in forming deep drawing of all type of instruments thru the specialized craftsmen. They annealed the forging process and prepare the materials for milling process.

3:- MILLING PROCESS.

Milling process is performed by the highly skilled machinist they are fully trained in accurately forming the male-female portions of box-joints forceps as well as serrations- ratches and other wide range of instruments in uniformity. Almost all types of mechanical works are performed at the same place.

4:- FILLING.

Hand-made fabrication makes almost all items precise and finest in look and that is done by specialized and skilled persons who assemble male /female portions after adjusting of extracting forceps and scissors, tips, serrations, ratches and all other type of items in uniformity and file precisely to make it semi-finish under strict quality control specifications.

5:-TEMPERING

All instruments are being tempered maintaining "Rock-Well Hardness". The tempering varies from 45 to 55 for various types of instruments. A hardness test is taken after tempering of each lot to maintain the uniformity. Further Passivation or a chemical process is performed to clean the items chemically.

6:- RIVETING

A wide range of assembly operation is performed from prototype quantities to production run. Each instrument is riveted / welded or spot welded precisely according to the requirement.

7:- GRINDING / POLISHING

Finally, to get the best finished products it is necessary to facilitate the craftsman with précised grinding and polishing equipment's for high uniformity utilizing best of polishing luster. Electro-plating and glass head process is used for the shined and matt finished steel instruments.

We are proud to say that Let us serve you to the best of our abilities.

For any query, call or mail us: info@frizkontools.com or visit www.frizkontools.com

FRIZKON INTERNATIONAL

Contact:- +92 52 3306091

+92 3325334864

+92 3436467358

TABLE OF CONTENTS



TABLE OF CONTENT

Specula	1-6	lacrimal instruments	121-128
Retractors	7-12	Dilators/ Probes	122-124
Self Retaining	8	Rongeurs	124-125
Retractors - finger Held	9-12	Chisels	126
Knives	13-16	elevators	126
foreign body instruments	16-19	Trephine	127
Curettes	20-21	nasal Specula	127-128
Spatulas	22-25	Mallets	128
nucleus instruments/ iOI Manipulators	26-32	Calipers	129-131
Hooks (iOI Manipulating, iris and other)	33-38	blades, Scalpels & Accessories	132-134
fixation Rings	39	Knife Handles	133
loops & Spoons	40-41	Care & Cleaning	135-142
forceps	42-75	Cassettes & Trays	140-142
Hemostats & Clamps	76-81	Suggested Sets	143-156
Scissors	82-112	Cannulae & Depressor	157-158
needle Holders	113-120	Reference, Warranty & Repair	159-166
		index	167-174



SPECULA



BARRAQUER Wire Speculum

1-3/4" (4.4 cm), large blades 14 mm
 1-1/4" (3.2 cm), small blades 10 mm



FT-18-35



FT-18-36

BARRAQUER Wire Speculum, Solid Blades

1-1/3" (3.3 cm), small blades 10 mm
 1-1/2" (3.8 cm), large blades 15 mm



FT-18-17



FT-18-18

KRATZ-BARRAQUER Wire Speculum

One solid and one open wire 15 mm blades

1-1/2" (3.8 cm), for left eye
 1-1/2" (3.8 cm), for right eye



FT-18-7



FT-18-8

KRATZ-BARRAQUER Wire Speculum, with Wings

Designed to retract lids up and away from the globe to help minimize external pressure.

1-1/2" (3.8 cm), 15 mm blades

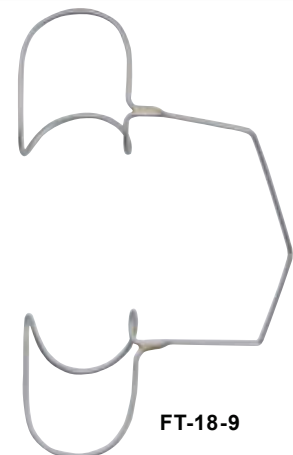

FT-18-9

NOTE: All above instruments are Non-Magnetic

Temporal Approach Wire Speculum

with spring on nasal side

1-1/2" (3.8 cm), open wire, 15 mm blades

1-1/2" (3.8 cm), closed wire, 15 mm blades

1-1/2" (3.8 cm), solid blades, 15 mm blades

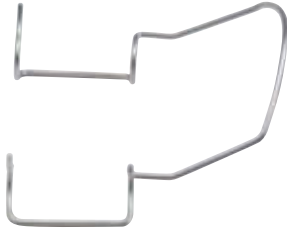

FT-18-44

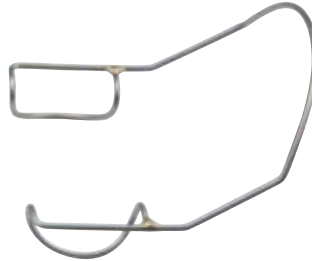

FT-18-45



FT-18-46

Infant Lid Speculum

closed wire blades with gently curved springs

1-1/3" (3.3 cm), 4 mm blades

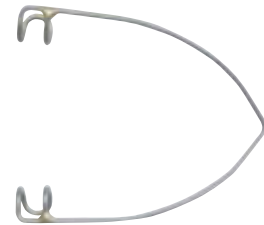

FT-18-595

Plain Wire Eye Speculum

2-1/2" (6.4 cm), 15 mm blades

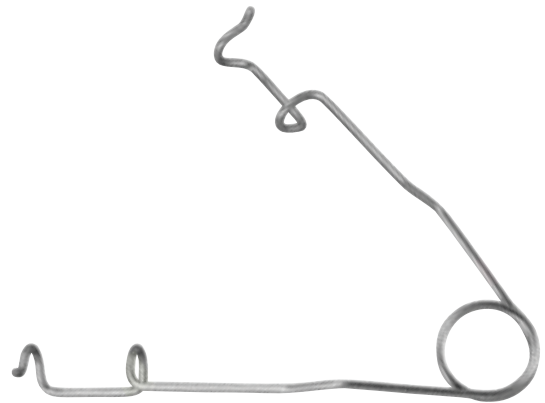

FT-18-34

FEASTER Wire Speculum, Extra Large Solid Blades

1-1/2" (3.8 cm), 20 mm blades



FT-18-40

NOTE: All above instruments are Non-Magnetic

SPECULA



McINTYRE Wire Speculum, V-Shaped Blades

Blade shape helps to position and hold surgical drape under the eyelids.

2" (5.1 cm), closed wire, 13 mm blades

2" (5.1 cm), open wire, 13 mm blades

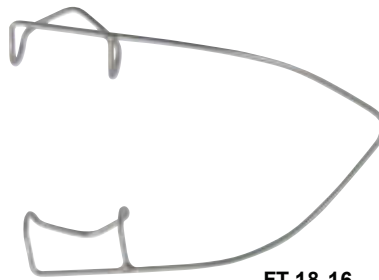

FT-18-16

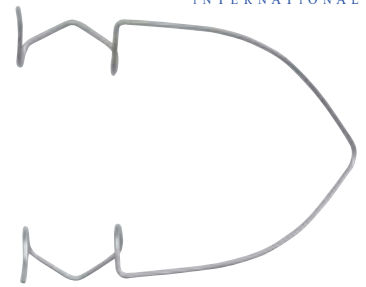

FT-18-596

SAUER Eye Speculum, Solid Blades

1-1/4" (3.2 cm), for infants, 10 mm blades

1" (2.5 cm), for premature infants, 2 mm blades



FT-18-47



FT-18-3

MURDOCK Eye Speculum, Closed Wire Blades

2-1/4" (5.7 cm), 15 mm blades



FT-18-50

COOK Eye Speculum, Solid Blades

with bottom locking screw

1-7/8" (4.7 cm), infant size, 9 mm blades

1-7/8" (4.7 cm), child size, 11 mm blades



FT-18-63



FT-18-64

NOTE: All above instruments are Non-Magnetic

SPECULA

MELLINGER Eye Speculum, Self Retaining

for optimized access with Phaco or I/A tip to the cataract incision.

2-3/4" (7 cm), solid 15 mm blades

2-3/4" (7 cm), fenestrated 15 mm blades

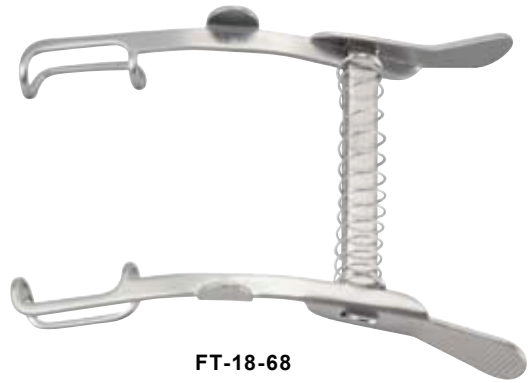
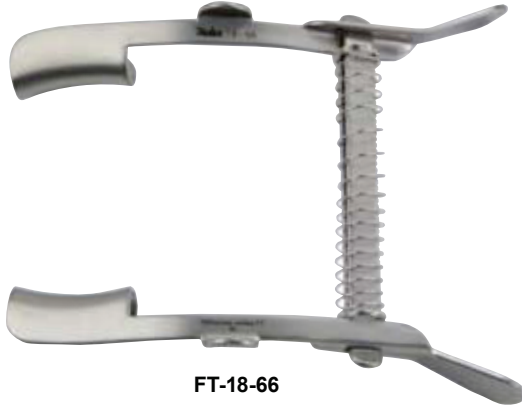

LANCASTER Eye Speculum, Solid Blades

with adjustable locking mechanism

3-1/4" (8.3 cm), 15 x 5 mm blades



KNAPP Eye Speculum

with adjustable locking mechanism

3-1/4" (8.3 cm), 15 x 6 mm blades



CASTROVIEJO Eye Speculum

with adjustable locking mechanism

4" (10.2 cm), large, 18 x 5 mm blades



NOTE: All above instruments are Non-Magnetic

SPECULA



CASTROVIEJO Eye Speculum
with adjustable locking mechanism
3-3/4" (9.5 cm), medium, 15 x 5 mm blades



WILLIAMS Eye Speculum
with adjustable locking mechanism
3-1/4" (8.3 cm), large, 15 x 5 mm blades



WILLIAMS Eye Speculum
with adjustable locking mechanism
2-3/4" (7 cm), small, 11 x 5 mm blades



LIEBERMAN Eye Speculum, Solid Blades
with adjustable locking mechanism
2-3/4" (7 cm), pediatric, infant & small children, 10 mm blades
2-3/4" (7 cm), standard size, 15 mm blades



NOTE: All above instruments are Non-Magnetic

SPECULA



LIEBERMAN Eye Speculum, Kratz Style Open Wire Blades
with adjustable locking mechanism
2-3/4" (7 cm), 15 mm blades

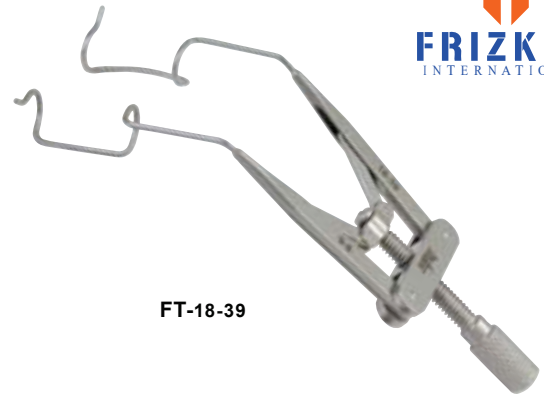

FT-18-39

GUYTON-PARK Eye Speculum, with Suture Posts & Canthus Hook
vertical and horizontal positioning with adjustable locking mechanism
3-1/2" (8.9 cm), fenestrated 14 mm blades

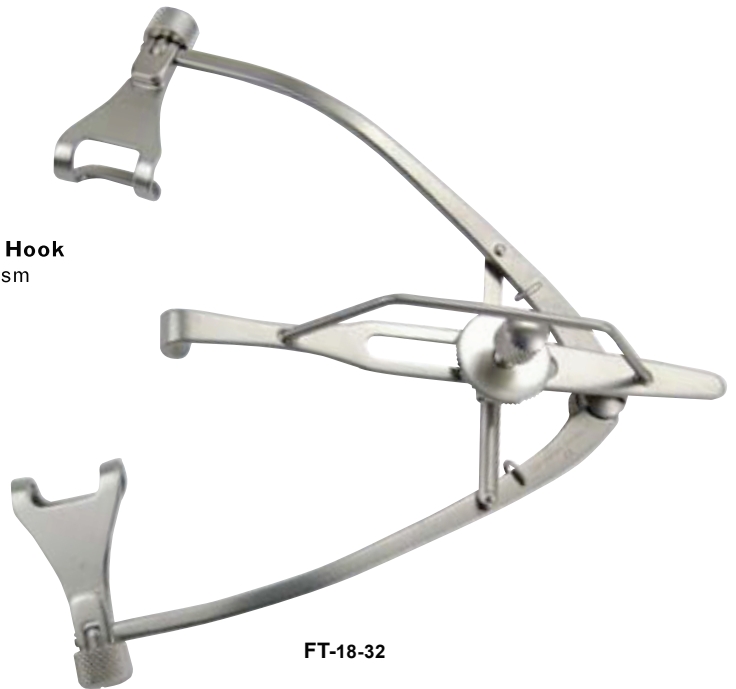

FT-18-32

MAUMENEE-PARK Eye Speculum, with Canthus Hook
vertical and horizontal positioning with adjustable locking mechanism
3-1/4" (8.3 cm), solid 14 mm blades



FT-18-33

NOTE: All above instruments are Non-Magnetic

RETRACTORS

SELF RETAINING

FINGER HELD



RETRACTORS-SELF RETAINING



AGRICOLA Lacrimal Sac Retractor
with adjustable locking mechanism
1-1/2" (3.8 cm), 3 x 3 sharp prongs, 4 mm deep

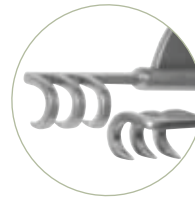

FT-18-80

MELLER Lacrimal Sac Retractor
with adjustable locking mechanism
2-7/8" (7.3 cm), 3 x 3 sharp prongs, 3 mm deep

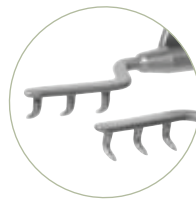

FT-18-84

GOLDSTEIN Lacrimal Sac Retractor
with adjustable locking mechanism
1-1/8" (2.8 cm), 3 x 3 sharp prongs, 5 mm deep

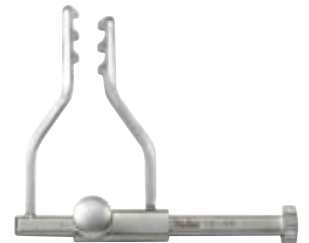

FT-18-88

STEVENSON Lacrimal Sac Retractor
with adjustable locking mechanism
3-1/4" (8.3 cm), 3 x 3 sharp prongs, 3 mm deep



FT-18-96

NOTE: All above instruments are Non-Magnetic

RETRACTORS-FINGERHELD



DESMARRES Lid Retractor

5-1/2" (14 cm)
 size 0, 10 mm
 size 1, 12 mm
 size 2, 14 mm
 size 3, 16 mm
 size 4, 18 mm



FT-18-110



FT-4315



FT-18-110



FT-18-112



FT-18-114



FT-18-116

DESMARRES Lid Retractor, Insulated

5-1/2" (14 cm)
 size 0, 10 mm
 size 1, 12 mm
 size 2, 14 mm



FT-4315in



FT-4315in



FT-4316in



FT-4317in

KAWAMOTO Double Ended Retractor, Insulated

6" (15.2 cm)
 14 mm & 16 mm
 8 mm & 10 mm
 5 mm & 10 mm



FT-4320



FT-4326



FT-4347

KASDAN Retractor, Double Ended

6-1/4" (15.9 cm)
 13 x 6.5 mm & 19 x 9.5 mm working ends



FT-760

RETRACTORS-FINGERHELD



Zare M-ba Ylis eyelid r etractor

clear autoclavable plastic

FT-4329* 5-1/4" (13.3 cm), 13 mm wide



FT-4329

cl ODius Orbital r etractor, Double ended

often called a "Z-type Retractor"

FT-652* 6-1/4" (15.9 cm), 13 mm & 20 mm wide ends



FT-652

JaeGer lid plate

FT-120 4-1/4" (10.8 cm), blades 20 mm & 23 mm

FT-5020* 4-1/4" (10.8 cm), blades 21 mm & 24 mm (not shown)



FT-120

fOMOn ball end r etractors, with blunt ball ends

FT-5430* 6-1/4" (15.9 cm), single prong, with blunt ball end

FT-5435* 6-1/4" (15.9 cm), double prong 11 mm wide

FT-5381* 6-1/4" (15.9 cm), double prong 13 mm wide, round knurled handle



1/1



FT-5430



FT-5435



FT-5381

RETRACTORS-FINGERHELD



FT-11-30

Flexible Neck Rake & Lacrimal Sac Retractor

6" (15.2 cm)

- 1 sharp prong
- 2 sharp prongs, 5 mm wide
- 3 sharp prongs, 8 mm wide
- 1 blunt prong
- 2 blunt prongs, 5 mm wide
- 3 blunt prongs, 8 mm wide

1



FT-11-30

1



FT-11-36

2



FT-11-32

2



FT-11-38

3



FT-11-34

3



FT-11-40

KNAPP Lacrimal Sac Retractor, Flexible Neck

5" (12.7 cm), 3 sharp prongs



FT-11D-27

KNAPP (ROLLET) Retractor

5-1/4" (13.3 cm), 4 sharp prongs

5-1/4" (13.3 cm), 4 blunt prongs

FT-18-100



FT-18-102



SCHEPENS Orbital Retractor

6-1/8" (15.6 cm), slightly curved

FT-18-250



RETRACTORS-FINGERHELD



McGANNON Retractor, fenestrated blade
5" (12.7 cm), 2.5 mm wide



FT-18-439

ADAMSON Double Ended Hook & Retractor
6-1/4" (15.9 cm), 7.5 x 5 mm retractor, 3 mm hook



FT-9056

WRIGHT Fascia Needle
2 mm wide tip, 1 x 6 mm oval eye
5-1/2" (14 cm)



FT-18-569

Smith Corneal Protection Shields
autoclavable, green, 21 mm diameter
non-autoclavable, white, 21 mm diameter (not shown)



FT-4311
FT-4312

Laser Eye Shields
non-glare, autoclavable
Laser Eye Shield only, 1" (25 mm) diameter
Laser Eye Shield Kit: 2 Shields FT-5010, 1 Suction Handle FT-5015
Spare Suction Handle for laser eye shield fits FT-5010 & FT-5012



FT-5010



FT-5015

KNIVES
&
FOREIGN BODY INSTRUMENTS



KNIVES

VON GRAEFE Cataract Knife

- 1 4-3/4" (12.1 cm), No. 1, 1.5 x 25 mm
- 2 4-3/4" (12.1 cm), No. 2, 1.7 x 27 mm
- 3 4-3/4" (12.1 cm), No. 3, 2 x 30 mm
- 4 5" (12.7 cm), No. 4, 2.3 x 33 mm
- 5 5" (12.7 cm), No. 5, 2.5 x 35 mm

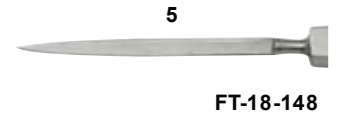
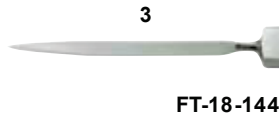
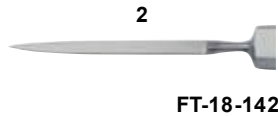

KNAPP Cataract Knife

4-1/2" (11.4 cm), 1 x 20 mm



WHEELER Dissection Knife

4-1/2" (11.4 cm), 1 x 18 mm



ZIEGLER Knife-Needle

- 1 4-1/4" (10.8 cm), size 0, 3 mm blade
- 2 4-1/4" (10.8 cm), size 1, 5 mm blade
- 3 4-1/2" (11.4 cm), size 2, 6 mm blade
- 4 4-1/2" (11.4 cm), size 3, 7 mm blade

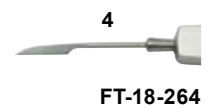
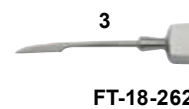
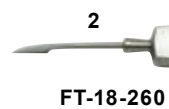

KNAPP Knife-Needle

4-1/2" (11.4 cm), 5 mm blade



KNIVES



DEAN Knife-Needle

5" (12.7 cm), curved blade 1 x 7 mm



FT-18-292

BOWMAN Needle with Stop

4-3/4" (12.1 cm), straight blade 3 mm



FT-18-308

GILL Corneal Knife

slightly curved cutting edge
4-3/4" (12.1 cm), 3.5 mm wide blade



FT-18-330

TOOKE Corneal Knife

4-1/2" (11.4 cm), 2.5 x 15 mm dissecting blade



FT-18-350

DESMARRES Corneal Dissector

4-3/4" (12.1 cm), 3 x 8 mm blade



FT-18-331

WALTER Corneal Spud

4-5/8" (11.8 cm)
straight blade 4 mm
curved blade 4 mm

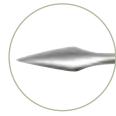

FT-18-302

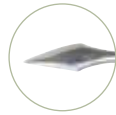

FT-18-304

VON GRAEFE (BECKER) Cystotome

malleable shaft, right angle blade
4-3/4" (12.1 cm), 1 mm blade



FT-18-314

WILDER Cystotome

angled blade
4-3/4" (12.1 cm), 3 mm edge



FT-18-320

BARKAN Goniotomy Knife

4-1/2" (11.4 cm), 2.5 mm blade



FT-18-344

DAVIS Foreign Body Spud

4-3/4" (12.1 cm), 0.8 mm blade



FT-18-372

DIX Foreign Body Spud
4-3/4" (12.1 cm), 1.7 x 15 mm blade



FT-18-374

ELLIS Foreign Body Spud
4-1/2" (11.4 cm), 1.2 mm blade, curved



FT-18-380

ALVIS Foreign Body Spud
oval curette
4-3/4" (12.1 cm), 1 x 3 mm with fine point



FT-18-384

HOSFORD Foreign Body Spud
Gouge Blade 1 x 7 mm rounded tip,
4-1/2" (11.4 cm)
angled to right
angled to left



FT-18-388



FT-18-390

Golf Club Foreign Body Spud
angled and lightly rounded tip
4-1/2" (11.4 cm)



FT-18-301

DIX Foreign Body Needle & Spud
protected in sliding handle
3-3/4" (9.5 cm) closed length



FT-18-400

DIX Foreign Body Needle & Spud
protected in reversible screw handle
4-1/2" (11.4 cm) closed length

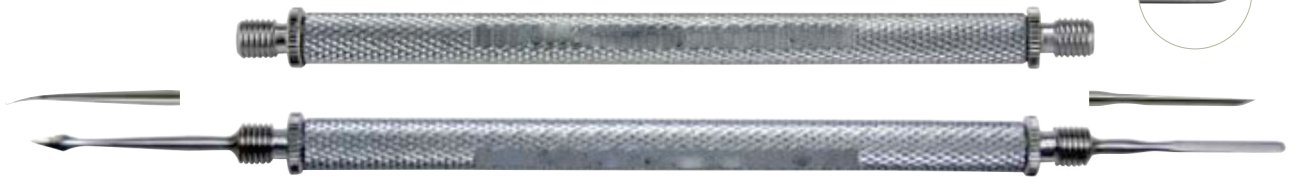
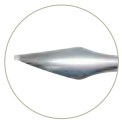

FT-18-402

DIX Foreign Body Needle
replacement, fits 18-402 screw handle

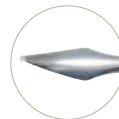

FT-18-402 a

DIX Foreign Body Spud
replacement, fits 18-402 screw handle

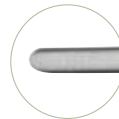

FT-18-402 b

DIX Foreign Body Needle & Gouge
protected in reversible screw handle
4-1/2" (11.4 cm) closed length



FT-18-404

Foreign Body Needle
4-3/4" (12.1 cm), 2 x 5 mm blade



FT-18-370

WALTON Foreign Body Gouge
4-1/2" (11.4 cm), grooved, rounded end



FT-18-376

Eye Magnet & Foreign Body Loop
magnet probe and plastic wire loop
working ends are reversible to fit inside
the pencil-shaped handle; provided
with protective carrying case
4" (10.2 cm) closed length



FT-18-398

Eye Magnet & Foreign Body Loop
with adjustable magnifier attached,
magnet probe and loop working ends are
reversible and fit inside the plastic handle;
provided with protective carrying case
5" (12.7 cm) closed length



FT-18-398M

Nawrooz® Eye Magnet
a powerful magnetic cylinder with round
and pointed interchangeable tips; provided
in a velvet lined steel carrying case
3-1/4" (8.4 cm) magnet length



FT-18-399

CURRETES & SPATULAS

&

FOREIGN BODY INSTRUMENTS



CURETS



MEYERHOEFER Chalazion Curette

- round cup, 5" (12.7 cm)
- 1 size 00, 1.0 mm
 - 2 size 0, 1.5 mm
 - 3 size 1, 1.7 mm
 - 4 size 2, 2.0 mm
 - 5 size 3, 2.5 mm
 - 6 size 4, 3.5 mm

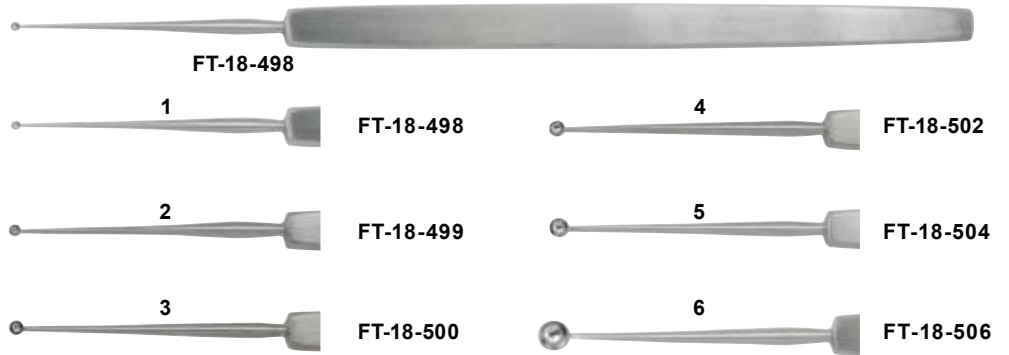

HEBRA Chalazion Curette

- oval cup, 5" (12.7 cm)
- 1.0 x 1.7 mm
 - 2.0 x 3.3 mm
 - 2.5 x 4.0 mm



SKEELE Chalazion Curette

- round cup, serrated edge, 5" (12.7 cm)
- 1.0 mm
 - 2.0 mm
 - 2.5 mm

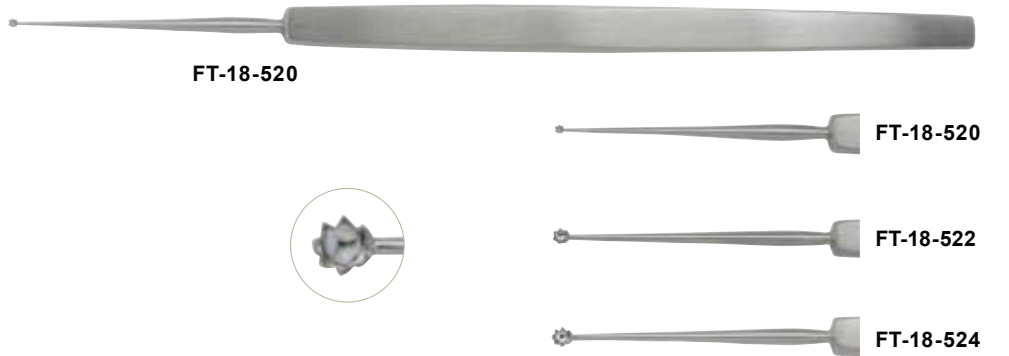

HEATH Chalazion Curette

- one sharp and one blunt edge, 4" (10.2 cm)
- 1 size 0, 0.5 mm
 - 2 size 1, 1.0 mm
 - 3 size 2, 2.0 mm
 - 4 size 3, 3.0 mm

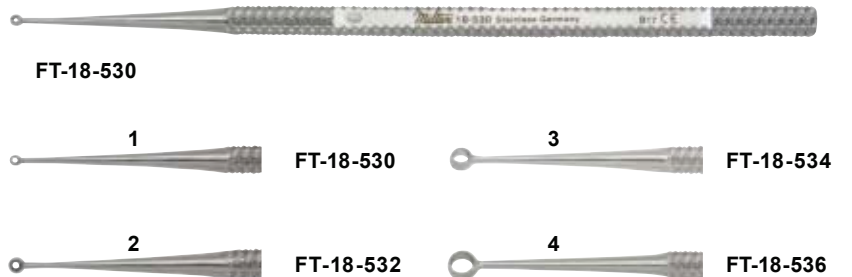

SPATULAS



CASTROVIEJO Spatula

double ended, sterling, 3.5 mm wide angled and 2 mm wide slightly curved
5-1/2" (14 cm)



FT-18-564

GREEN Spatula

double ended, 4 x 14 mm,
and 5 x 16 mm curved
working ends
6" (15.2 cm)



FT-18-570

SMITH-FISHER Iris Spatula

double ended, sterling, one flat end
2 mm wide, one spoon end 2 mm,
curved working ends
5" (12.7 cm)



FT-18-566

WECKER Iris Spatula

sterling blade 2 x 30 mm
5" (12.7 cm)



FT-18-584

FISHER Spoon & Needle

curved spoon end 7 x 15 mm, needle 33 mm long
5-1/2" (14 cm)



FT-18-568



SPATULAS



LINDNER Cyclodialysis Spoon & Spatula

double ended, curved, malleable spatula
end is graduated in 6 mm increments
5-1/2" (14 cm)



FT-18-562

CASTROVIEJO Cyclodialysis Spatula

double ended, 5-1/4" (13.3 cm)
blades 10 mm & 15 mm, 0.75 mm wide
blades 10 mm & 15 mm, 0.5 mm wide



FT-18-573a

FT-18-574

FT-18-573a
FT-18-574

CASTROVIEJO Cyclodialysis Spatula

blade 1 x 10 mm
5-1/4" (13.3 cm)



FT-18-576

KRITZINGER-UPDEGRAFF LASIK Flap Elevator & Manipulator

for LASIK Flap; elevator cuts the
epithelium and manipulator lifts flap
during LASIK procedure
5" (12.7 cm)



FT-18-2028

SLADE LASIK Retreatment Spatula
for lifting the flap and separating the epithelium
4-3/4" (12.1 cm), with semi-sharp edges
1.0 mm wide tip, smooth
1.3 mm wide tip, with serrations



FT-18-593

FT-18-594

FT-18-593
FT-18-594

SPATULAS



MACHAT LASIK Retreatment Spatula
angulated tip helps to separate and break
epithelial bond, spatula aids lifting flap
and separating epithelium
5" (12.7 cm)



FT-18-597

HERZIG LASIK Elevator & Retreatment Spatula
5" (12.7 cm)



FT-18-592

JAFFE Lens Spatula
flat, 0.5 mm wide
4-3/4" (12.1 cm)



FT-18-586

HIRSCHMAN Lens Spatula
flat, 0.5 mm wide with multiple notches
4-3/4" (12.1 cm)



FT-18-585

OBSTBAUM Synechiaes Spatula
0.25 mm wide with semi-sharp tip
5" (12.7 cm)



FT-18-590

SPATULAS

GIRARD Synechiaie Spatula
0.5 mm wide with semi-sharp tip
4-1/2" (11.4cm)



FT-18-591

KOCH Nucleus Spatula
gently curved duckbill shaped tip, smooth
4-1/2" (11.4 cm)



FT-18-587

LIPPMAN Nucleus Spatula
0.5 mm diameter round shaft with blunt forked tip
4-1/2" (11.4 cm)



FT-18-588

NAGAHARA Nucleus Spatula
flat inferior edge
4-1/2" (11.4 cm)



FT-18-589

NUCLEUS INSTRUMENTS

&

10L MANIPULATORS



ROSEN Phaco Splitter
wedge shaped inferior edge with blunt tip
4-1/2" (11.4 cm)



FT-18-2014

ROSEN Phaco Splitter
60° angled wedge shaped inferior edge with blunt tip
4-1/2" (11.4 cm)



FT-18-2015

ROWEN Phaco Splitter Combo
Rosen Phaco Splitter with wedge shaped inferior edge and blunt tip, Bechert Nucleus Rotator with blunt forked tip angled at 7 mm
5" (12.7 cm)

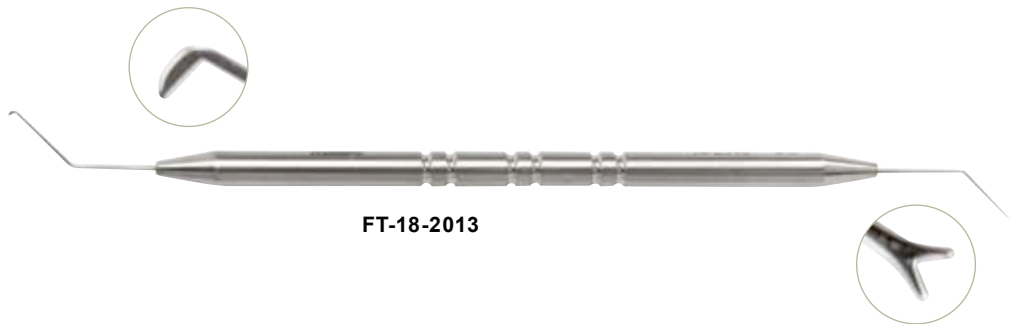

FT-18-2013

KOCH Phaco Manipulator & Splitter
thin and smooth spatula to push, rotate, lift and split nucleus
4-1/2" (11.4 cm), 0.8 mm tip



FT-18-2029

NAGAHARA Phaco Chopper
60° 1.5 mm cutting edge
4-1/2" (11.4 cm)



FT-18-2018

NAGAHARA Phaco Chopper

90° 1.5 mm cutting edge
4-1/2" (11.4 cm)



FT-18-2019

CHANG DUO Quick Chopper, Left

5-1/2" (14 cm)



FT-18-2017

BECHERT Nucleus Rotator

blunt forked tip angled at 7 mm
4-1/2" (11.4 cm)



FT-18-2007

JAFFE-BECHERT Nucleus Rotator

blunt forked tip angled at 9 mm
4-1/2" (11.4 cm)



FT-18-2008

CLAYMAN Nucleus Rotator

0.5 mm wide flat spatula with V-notched tip
4-3/4" (12.1 cm)



FT-18-2009

PISACANO Nucleus Rotator
flat disc shaped tip, horizontal
4-1/2" (11.4 cm)



FT-18-2010

PISACANO Nucleus Rotator
flat disc shaped tip, vertical
4-1/2" (11.4 cm)



FT-18-2011

TENNANT Nucleus Rotator
0.6 mm diameter ball tip, angled
4-3/4" (12.1 cm)



FT-18-2012

ANIS Ball Tip Nucleus Manipulator
0.5 mm diameter ball tip, straight
4-1/2" (11.4 cm)



FT-18-2021

ANIS Ball Tip Nucleus Manipulator
0.5 mm diameter ball tip, angled
4-1/2" (11.4 cm)



FT-18-2022



DRYSDALE Nucleus Manipulator
paddle shaped tip
4-1/2" (11.4 cm)

FT-18-2023



SIEPSER Endocapsular Controller
trumpet shaped tip
4-1/2" (11.4 cm)

FT-18-2020



KANSAS Nucleus Bisector
for manual surgery with small incision to
divide nucleus into 2 pieces
4-1/2" (11.4 cm)

FT-18-2003

KANSAS Nucleus Trisector

4 mm wide, for manual surgery with small incision to divide nucleus into 3 pieces, recommended use with 18-2002 KANSAS Nucleus Vectis (see below) 4" (10.2 cm)



FT-18-2006

BUCHER-KANSAS Nucleus Trisector

2.5 mm wide, for manual surgery with small incision to divide nucleus into 3 pieces, recommended use with 18-2002 KANSAS Nucleus Vectis or 18-2031 ALFONSO Cutting Platform (see below) 4-1/4" (10.8 cm)



18-2005

ALFONSO Nucleus Trisector

1.5 mm wide, for manual surgery with small incision to divide nucleus into 3 pieces, recommended use with 18-2002 KANSAS Nucleus Vectis or 18-2030 ALFONSO Cutting Platform (see below) 4-1/4" (10.8 cm)



FT-18-2004

KANSAS Nucleus Vectis

3.0 mm wide solid blade used as a cutting block for nucleus bisector and trisector 4-1/2" (11.4 cm)



FT-18-2002

ALFONSO Cutting Platform

used as a cutting block for nucleus trisector during manual small incision surgery 5" (12.7 cm), 2 mm wide, used with 18-2004 5" (12.7 cm), 3 mm wide, used with 18-2005



**FT-18-2030
FT-18-2031 (not shown)**

HUNKELER IOL Manipulator

0.3 mm diameter hemi-ball tip
5" (12.7 cm)



FT-18-2024

LESTER IOL Manipulator

0.25 mm diameter tip, straight with guard,
for multi-directional IOL manipulation
4-3/4" (12.1 cm)
Replacement guard/cap



FT-18-2033

FT-18-2025

LESTER IOL Manipulator

0.25 mm diameter tip, angled, for
multi-directional IOL manipulation
4-3/4" (12.1 cm)



FT-18-2026

MALONEY IOL Manipulator

0.25 mm diameter tip, vaulted shank
with guard
4-3/4" (12.1 cm)
Replacement guard/cap



FT-18-2033

FT-18-2027

IOL MANIPULATING HOOKS

IRIS HOOKS

OTHER MISCELLANEOUS HOOKS

FIXATION RINGS



IOL MANIPULATING INSTRUMENTS



CLAYMAN-JAFFE Lens Manipulating Hook

0.15 mm diameter blunt tip, angled
4-1/2" (11.4 cm)



FT-18-455

JAFFE Lens Manipulating Hook

0.15 mm diameter blunt tip, straight
4-1/2" (11.4 cm)



FT-18-456

FENZL Lens Manipulating Hook

0.15 mm diameter tip
4-3/4" (12.1 cm), straight with guard
4-3/4" (12.1 cm), angled
Replacement guard/cap



FT-18-457

FT-18-458

FT-18-2033

SINSKEY Lens Manipulating Hook

0.25 mm diameter blunt tip
4-1/2" (11.4 cm), straight with guard
4-1/2" (11.4 cm), angled
Replacement guard/cap



FT-18-463

FT-18-464

FT-18-2033

SINSKEY II Lens Manipulating Hook

0.20 mm diameter blunt tip
4-1/2" (11.4 cm), straight, with guard
4-1/2" (11.4 cm), angled
Replacement guard/cap



FT-18-465

FT-18-466

FT-18-2033



IOL MANIPULATING INSTRUMENTS



MALTZMAN-FENZL Lens Manipulating Hook

0.15 mm diameter tip
4-3/4" (12.1 cm), angled
Replacement guard/cap



FT-18-2033



FT-18-459



FT-18-460

OSHER Y-Hook Lens Manipulator

4-3/4" (12.1 cm), straight with guard
Replacement guard/cap



FT-18-2033



FT-18-461

RENTSCH "Boat Hook" Lens Manipulator

multi-purpose instrument for iris/capsule
retraction and/or lens manipulation
4-3/4" (12.1 cm), straight with guard
Replacement guard/cap



FT-18-2033



FT-18-462

KUGLEN Iris Hook & Lens Manipulator

push-pull pattern
4-1/2" (11.4 cm), straight with guard
4-1/2" (11.4 cm), angled
Replacement guard/cap



FT-18-2033



FT-18-467



FT-18-468

SHEPARD Iris Hook

1.0 mm wide tip
4-3/4" (12.1 cm), blunt



FT-18-421

HOOKS

KNOLLE Iris Hook
0.8 mm wide tip
4-3/4" (12.1 cm), small, blunt

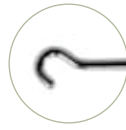

FT-18-470

HIRSCHMAN Iris Hook
4-1/2" (11.4 cm), blunt, angled



FT-18-469

WIENER Corneal Hook
5" (12.7 cm), sharp
5" (12.7 cm), blunt



FT-18-418



FT-18-420

OSHER Utility Hook
multi-purpose IOL Hook for retrieving
dislocated IOLs, working IOL out of eye
during explanation and performing iris
tuck reduction with anterior chamber IOLs
4-1/2" (11.4 cm), angled tip



FT-18-417

GUTHRIE Fixation Hook
sharp double prongs, 1.5 mm wide
5" (12.7 cm)

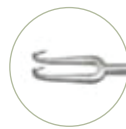

FT-18-416

HOOKS

TYRELL Hook
5" (12.7 cm), sharp
5" (12.7 cm), blunt



FT-18-412



FT-18-414

O'CONNOR Hook
4-3/4" (12.1 cm), sharp



FT-18-424

NUGENT Hook
4-3/4" (12.1 cm), right angle, sharp



FT-18-428

McGANNON Hook & Retractor
2.5 mm wide
5" (12.7 cm), fenestrated blade



FT-18-439

STEVENS Tenotomy Hook
5 mm deep
5" (12.7 cm), right angle



FT-18-440

HOOKS



GREEN Strabismus Hook
5" (12.7 cm), 9 mm deep



FT-18-442

JAMESON Strabismus Hook
5" (12.7 cm), 10 mm deep



FT-18-446

VON GRAEFE Strabismus Hook
5-1/2" (14 cm)
small, 8 mm long
medium, 10 mm long
large, 11 mm long



FT-18-450



FT-18-450



FT-18-452



FT-18-454

KIRBY Muscle Hook & Expressor, Double Ended
6" (15.2 cm)



FT-18-613

Nawrooz® Hook
2 mm diameter
4-3/4" (12.1 cm), sharp



FT-21-152

SELTZER Hook
4-1/2" (11.4 cm), sharp



FT-33-121

FIXATION RINGS

GASS Retinal Detachment Hook

5-3/4" (14.6 cm), with oval hole



FT-18-2127

THORTON Globe Fixation Ring

16 mm diameter ring, multiple blunt atraumatic teeth, for refractive surgery procedures
4" (10.2 cm)



FT-18-121

HOFMANN-THORTON Globe Fixation Ring

16 mm diameter ring, with swivel handle, multiple blunt atraumatic teeth, for refractive surgery procedures
4-1/4" (10.8 cm)



FT-18-122

FINE-THORTON Swivel Fixation Ring

13 mm diameter ring for clear cornea incisions, with swivel handle, multiple blunt teeth, marks in 15° increments for guide and placement of limbal relaxing incisions
4-1/4" (10.8 cm)



FT-18-123

FINE-THORTON Swivel Fixation Ring

16 mm diameter ring for scleral tunnel incisions, with swivel handle, multiple blunt teeth, marks in 15° increments for guide and placement of limbal relaxing incisions
4-1/4" (10.8 cm)



FT-18-124

KNIVES
&
FOREIGN BODY INSTRUMENTS



LOOPS & SPOONS



LEWIS Lens Loop

5-1/4" (13.3 cm)
serrated loop, 5.5 x 8 mm
smooth loop, 5.5 x 8 mm



FT-18-480



FT-18-480



FT-18-482

WILDER Lens Loop

5-1/4" (13.3 cm)
serrated loop, 4 x 15 mm
smooth loop, 4 x 15 mm



FT-18-484



FT-18-484



FT-18-486

FISHER Spoon and Needle

curved spoon end 7 x 15 mm,
needle 33 mm long
5-1/2" (14 cm)



FT-18-568

DAVIEL Lens Spoon

5" (12.7 cm), 3 mm wide



18-472

BUNGE Evisceration Spoon

5-1/2" (14 cm)
small, 8 mm cup
large, 11 mm cup



FT-18-540



FT-18-540



FT-18-542

WELLS Enucleation Scoop

6" (15.2 cm), 21 mm cup



FT-18-550

FORCEPS



FORCEPS



KELLAN Capsulorhexis Forceps
 cupped tips for grasping the anterior capsule; tongue and groove feature at angle junction helps keep jaws aligned
 4" (10.2 cm), straight
 4" (10.2 cm), vaulted



FT-18-1095



FT-18-1096

KRAFF-UTRATA Capsulorhexis Forceps
 cystotome tips; tongue and groove feature at angle junction helps keep jaws aligned
 4" (10.2 cm), blunt tips
 4" (10.2 cm), sharp tips



FT-18-1097



FT-18-1098

INAMURA Capsulorhexis Forceps
 delicate tapered shanks and jaw profile seal incision and help eliminate viscoelastic leakage and flattening of the anterior chamber during continuous curvilinear capsulorhexis
 4-3/4" (12.1 cm)



FT-18-1094

ARRUGA Capsule Forceps
 4" (10.2 cm), standard curve
 4" (10.2 cm), new curve



FT-18-1000



FT-18-1002

Nawrooz® Extra-Capsular Forceps
 improved pattern with 11 x 11 teeth
 4" (10.2 cm), long convex curve



FT-18-1034

FORCEPS



CASTROVIEJO Capsule Forceps

cross action with stop to limit opening of blades
4" (10.2 cm)



FT-18-1050

SCHWEIGER Extra-Capsular Forceps

3-3/4" (9.5 cm), 4 x 5 teeth, curved



FT-18-1058

FUCHS Extra-Capsular Forceps

2-3/4" (7 cm), 5 x 5 teeth, angled



FT-18-1060

AKAHOSHI Combo Prechopper & AKAHOSHI Universal Prechopper

Intended for use on grades of nuclei with 1-2 hardness divided using Karate/Phaco Prechop technique, in which the nucleus is prechopped into 4 or more sections before introducing the phaco handpiece. Harder nuclei or nuclei with weak ciliary zonules should be prechopped very carefully and supported with a nucleus sustainer to reduce the stress on the ciliary zonules. This technique reduces ultrasound time by minimizing the conventional grooving method. The movement of the phaco tip is minimized and mechanical and thermal damage to the wound is reduced by dividing the nucleus beforehand.

Maximum opening of 3.0 mm at the site of incision.

AKAHOSHI Combo Prechopper

4-3/4" (12.1 cm)

AKAHOSHI Universal Prechopper

4-3/4" (12.1 cm)



FT-18-2000



FT-18-2001

FORCEPS



GASKIN Fragment Forceps

11 mm long smooth jaws
4" (10.2 cm), angled



FT-18-981

DODICK Nucleus Cracker

cross action; longitudinally serrated
paddle shaped jaws for cracking the
nucleus through 3 mm incision
4" (10.2 cm)



FT-18-2016

BURATTO II Acrylic IOL Implantation Forceps

very thin and smooth polished jaws for implanting
lens through a small incision
5" (12.7 cm), angled, without lock



FT-18-1071

CUMMING CrystaLens Forceps

specially designed jaws are placed across
the IOL for vertical removal of the lens
from the packaging and to help prevent
implanting the lens upside down
5" (12.7 cm), without lock



FT-18-1085

ZALDIVAR Micro Implantation Forceps

flat tip on the leading edge of the forceps helps implantation
through a small clear corneal incision; forceps enter a 3 mm
incision without stretching the incision size; jaws easily open
in the eye and are smoothly polished to avoid marking the lens;
forceps can be used to implant the superior haptic
5" (12.7 cm), without lock



FT-18-1090

FORCEPS

BURATTO Soft IOL Inserting Forceps
extra delicate highly polished convex jaws,
for foldable acrylic and silicone IOLs
4" (10.2 cm)



FT-18-1070

DODICK IOL Folding Forceps
for soft IOLs
4" (10.2 cm)



FT-18-1072

LIVERNOIS IOL Folding Forceps
concave jaw surfaces, for soft IOLs
4" (10.2 cm)



FT-18-1073



LIEBERMAN Micro Ring Lens Forceps
15° jaw angulation, facilitates implantation
of IOL, haptic and optic
4-1/2" (11.4 cm)



FT-18-1089

FORCEPS

SHEPARD Intraocular Lens Holding Forceps
17 mm gently curved jaws, serrated paddle shaped tips
4-1/2" (11.4 cm)



FT-18-1080

CLAYMAN Intraocular Lens Holding Forceps
15 mm gently curved jaws, angled delicate smooth tips
4-1/2" (11.4 cm)



FT-18-1081

CLAYMAN Lens Holding Forceps
delicate angled jaws and gently curved
5" (12.7 cm)



FT-18-1084

BECHERT Lens Holding Forceps
very delicate flat jaws gently curved
4-3/4" (12.1 cm)



FT-18-1082

BLAYDES Lens Holding Forceps
very delicate narrow and smooth jaws, angled 45°
4-1/2" (11.4 cm)



FT-18-1083

FORCEPS



FAULKNER Lens Holding Forceps
round smooth jaws for holding soft IOLs
4" (10.2 cm)



FT-18-1086

KRATZ Lens Holding Forceps
very delicate narrow jaws, curved
4-1/2" (11.4 cm)



FT-18-1087

PERONE LASIK Forceps
1.20 mm ring diameter, curved, fenestrated circular
rings for firm hold and lifting of the corneal flap
4" (10.2 cm)



FT-18-1093

BURATTO LASIK Flap Forceps
disc shaped serrated jaws, curved
4" (10.2 cm)



FT-18-1091

MENDEZ Multi-Purpose LASIK Forceps
for lifting, grasping and dissecting the
corneal flap, spatulated jaws and tips,
smooth grasping surface, vaulted
4" (10.2 cm)



FT-18-1092

FORCEPS



JAFFE Tying Forceps

0.3 x 6 mm long platform, very delicate smooth jaws, for 8-0 to 11-0 sutures
4" (10.2 cm), straight
4" (10.2 cm), curved



FT-18-920



FT-18-921

TENNANT Tying Forceps

6 mm long platform, extra delicate smooth jaws, round handle and guide pin, for 9-0 to 11-0 sutures
4" (10.2 cm), straight
4" (10.2 cm), curved



FT-18-923



FT-18-924

HARMS Tying & Suturing Forceps

0.6 mm wide at tip, smooth tying platform, 11 mm wide handles, for 7-0 to 9-0 sutures
4-1/8" (10.5 cm), straight
4-1/8" (10.5 cm), curved



FT-18-946



FT-18-947

KELMAN-McPHERSON Forceps

7.5 mm long platform, smooth jaws, ideal for implanting IOLs
4" (10.2 cm), angled

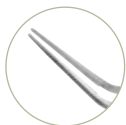

FT-18-931

McPHERSON Tying Forceps

5 mm long platform, smooth jaws, for 8-0 to 11-0 sutures
4" (10.2 cm), straight
4" (10.2 cm), angled



FT-18-922



FT-18-925

FORCEPS



McPHERSON Micro Iris Suturing Forceps

0.3 x 5 mm smooth platform
3-1/2" (8.9 cm), straight
3-1/2" (8.9 cm), angled

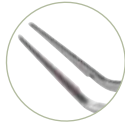
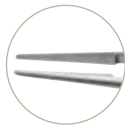

FT-18-948



FT-18-949

McPHERSON Tissue Forceps

1 x 2 teeth, 0.4 mm with tying platform
4" (10.2 cm), angled
4" (10.2 cm), straight



FT-18-929



FT-18-930

CASTROVIEJO Suturing Forceps

1 x 2 teeth with tying platform, narrow handles
4" (10.2 cm)
0.3 mm
0.5 mm
0.6 mm
0.9 mm



FT-18-951
FT-4909
FT-18-952
FT-18-950

CASTROVIEJO Suturing Forceps

1 x 2 teeth with tying platform,
11 mm wide handles
4-1/4" (10.8 cm)
0.12 mm, micro
0.6 mm
0.9 mm



FT-18-953
FT-18-954
FT-18-955

CASTROVIEJO Suturing Forceps

1 x 2 teeth with tying platform,
11 mm wide handles
4-1/4" (10.8 cm)
0.3 mm
0.5 mm
0.9 mm
1.5 mm

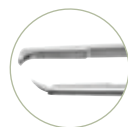

FT-3726
FT-4908
FT-3727
FT-3731

FORCEPS

BONN Micro Suturing Forceps

1 x 2 teeth with tying platform
2-3/4" (7.0 cm), 0.12 mm
3-3/4" (9.5 cm), 0.12 mm

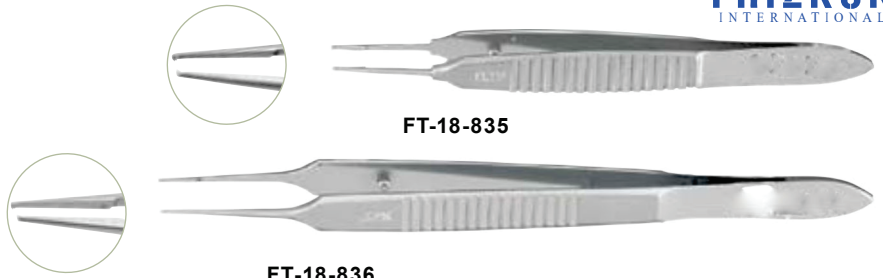

FT-18-835

FT-18-836

McPHERSON Micro Corneal Suturing Forceps

1 x 2 teeth with tying platform
3-1/2" (8.9 cm), straight, 0.2 mm
3-1/2" (8.9 cm), angled, 0.2 mm



FT-18-837

FT-18-838

McCULLOUGH Suturing Forceps

1 x 2 teeth with cross serrated jaws
4" (10.2 cm), 1.5 mm



FT-18-966

SAUER Suturing/Fixation Forceps

1 x 2 curved teeth overlapping each other
3-1/2" (8.9 cm), 0.6 mm



FT-18-974

MANHATTAN EYE & EAR Suturing/Fixation Forceps

1 x 2 curved teeth overlapping each other,
with smooth tying platform
3-1/2" (8.9 cm), 0.7 mm



FT-18-975

FORCEPS



HARMS Colibri Forceps

extra delicate 1 x 2 teeth with tying platform
2-7/8" (7.3 cm), 0.12 mm



FT-18-928

TROUTMAN-BARRAQUER Colibri Type Corneal Utility Forceps

1 x 2 teeth, set at 45° angle, with tying platform
3" (7.6 cm), 0.4 mm
3" (7.6 cm), 0.12 mm



FT-18-827



FT-18-828



FT-18-880

PIERSE Colibri Type Corneal Forceps

very delicate 1 x 1 teeth
3-1/4" (8.3 cm), 0.12 mm
3-1/4" (8.3 cm), 0.3 mm



FT-18-881

CASTROVIEJO Colibri Type Corneal Forceps

very delicate 1 x 2 teeth, with tying platform
4" (10.2 cm), 0.12 mm



FT-18-883

GILL Iris Forceps

1 x 2 teeth
2-7/8" (7.3 cm), 0.6 mm



FT-18-834



FORCEPS



GILL (CHANDLER) Iris Forceps
 fine cross serrated jaws, no teeth
 3" (7.6 cm), 0.6 mm



FT-18-825

GILL-HESS Iris Forceps
 1 x 2 teeth forward
 2-3/4" (7.0 cm), 0.5 mm



FT-18-830

BOTVIN Iris Forceps
 fine cross serrated jaws, no teeth
 2-7/8" (7.3 cm), 0.5 mm



FT-18-829

Eye Dressing Forceps
 extra delicate pattern, 0.5 mm serrated jaws
 4" (10.2 cm)
 straight
 half curved
 full curved

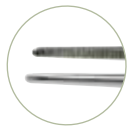

FT-18-779



FT-18-781



FT-18-783

Eye Dressing Forceps
 standard pattern, 0.8 mm serrated jaws
 4" (10.2 cm)
 straight
 half curved
 full curved

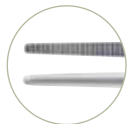

FT-18-780



FT-18-782



FT-18-784

FORCEPS



Iris Tissue Forceps

1 x 2 teeth, extra delicate pattern, 0.5 mm
4" (10.2 cm)
straight
half curved
full curved



FT-18-785



FT-18-789



FT-18-791

Iris Tissue Forceps

1 x 2 teeth, standard pattern, 0.8 mm
4" (10.2 cm)
straight, non-magnetic
half curved
full curved

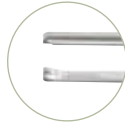

FT-18-786

FT-18-787



FT-18-788



FT-18-790

BISHOP-HARMON Dressing Forceps

fine cross serrated jaws
3-3/8" (8.6 cm), 0.5 mm

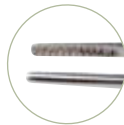

FT-18-866

BISHOP-HARMON Dressing Forceps

serrated
3-1/4" (8.3 cm), 0.6 mm

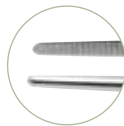

FT-4809

BISHOP-HARMON Tissue Forceps

1 x 2 teeth
3-3/8" (8.6 cm), delicate, 0.3 mm
3-3/8" (8.6 cm), standard, 0.7 mm



FT-18-867



FT-18-868

FORCEPS

BISHOP-HARMON Iris Tissue Forceps

1 x 2 teeth
 3-1/4" (8.3 cm), extra delicate, 0.3 mm
 3-1/4" (8.3 cm), delicate, 0.4 mm
 3-1/4" (8.3 cm), standard, 0.6 mm



FT-4793
 FT-4792
 FT-4791

FOERSTER Iris Tissue Forceps

1 x 2 teeth, octagonal grip
 3-3/4" (9.5 cm), straight, 0.5 mm
 3-3/4" (9.5 cm), full curved, 0.5 mm

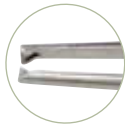

FT-18-796



FT-18-798

FOERSTER Eye Dressing Forceps

serrated, octagonal grip
 3-3/4" (9.5 cm), straight, 0.5 mm
 3-3/4" (9.5 cm), full curved, 0.5 mm

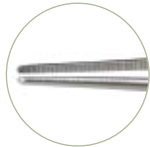

FT-18-795



FT-18-795a

O'CONNOR Iris Forceps

1 x 2 teeth, angled
 3-3/4" (9.5 cm), 0.5 x 9 mm



FT-18-793

STEVENS Iris Forceps

1 x 2 teeth, straight
 4" (10.2 cm), 1 mm



FT-18-804

FORCEPS



GRAEFE Iris Forceps
1 x 2 teeth
2-3/4" (7.0 cm), straight
2-3/4" (7.0 cm), curved



FT-18-816



FT-18-820

GRAEFE Eye Dressing Forceps
serrated
2-3/4" (7.0 cm), straight
2-3/4" (7.0 cm), curved



FT-18-814



FT-18-818

COBAUGH Iris Forceps
1 x 2 teeth
4" (10.2 cm), straight



FT-4212

COBAUGH Eye Dressing Forceps
serrated
4" (10.2 cm), straight

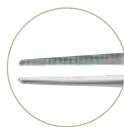

FT-4213

BRACKEN Iris Forceps
fine cross serrated jaws
4" (10.2 cm)



FT-18-794

FORCEPS



KIRBY Iris Forceps
1 x 2 teeth
4" (10.2 cm), straight
4" (10.2 cm), curved



FT-18-620



FT-18-624

KIRBY Fixation Forceps
1 x 2 teeth, with slide lock
4" (10.2 cm), straight



FT-18-628

KIRBY Cornea-Scleral Forceps
1 x 2 teeth
4" (10.2 cm), angled tips



FT-

FT-18-632

Strabismus Forceps
1 x 2 teeth
4" (10.2 cm), 1 mm



FT-18-840

Micro ADSON Tissue Forceps
1 x 2 teeth
4-3/4" (12.1 cm), 0.5 mm

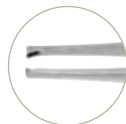

FT-17-2500

Micro ADSON Dressing Forceps
serrated
4-3/4" (12.1 cm), 0.5 mm



FT-17-2510

FORCEPS



SWISS Jeweler Style Forceps

Non-Magnetic Stainless Steel,
4-3/4" (12.1 cm)
style 1, fine
style 2, strong, fine
style 3, narrow, fine
style 3X, micro fine



FT-17-301



FT-17-302



FT-17-303



FT-17-303X

SWISS Jeweler Style Forceps

Non-Magnetic Stainless Steel,
4-3/8" (11.2 cm)
style 3C, narrow, fine
style 4, fine,
style 5, super fine
style 5, micro fine



FT-17-303c



FT-17-304



FT-17-305



FT-17-305X

SWISS Jeweler Style Forceps

Non-Magnetic Stainless Steel,
4-1/2" (11.4 cm)
style 6, pickup
style 7, fine, curved
style 7, micro fine, curved



FT-17-306



FT-17-307



FT-17-307X



FORCEPS



Micro (Jeweler) Forceps
delicate fine points
4-1/2" (11.4 cm), style 0



FT-4746

Micro (Jeweler) Forceps
fine points
5-1/4" (13.3 cm), style 26-SA



FT-4749

Micro (Jeweler) Forceps
angled
4-1/2" (11.4 cm)



FT-4928

Micro Suture Forceps
with tying platform
4-3/4" (12.1 cm) , 0.3 mm
6" (15.2 cm) , 0.3 mm



FT-4859
FT-4860 (not shown)

FORCEPS



LITTAUER Cilia Forceps

4 mm wide jaws with fine horizontal serrations
3-1/2" (8.9 cm)



FT-18-1100

BEER Cilia Forceps

4 mm wide smooth jaws
3-1/2" (8.9 cm)



FT-18-1102

ZIEGLER Cilia Forceps

2 mm wide serrated jaws
3-1/2" (8.9 cm)



FT-18-1104

DOUGLAS Cilia Forceps

thin jaws 2.5 mm wide, with fine horizontal serrations
3-1/2" (8.9 cm)



FT-18-1106

SWISS Cilia & Suture Forceps

3 mm wide precision fitted diagonal smooth jaws
3-3/4" (9.5 cm)



FT-18-1107



FORCEPS

BERGH Cilia Forceps

5 mm wide jaws with horizontal serrations
3-1/2" (8.9 cm)



FT-18-1110

BARRAQUER Cilia & Suture Forceps

5 mm smooth platform
4-1/2" (11.4 cm)



FT-18-1111

BENNETT Cilia Forceps

3 mm diameter cup shaped jaws, fenestrated
3" (7.6 cm)



FT-18-1112

BEAUPRE Cilia Forceps

12 mm long smooth jaws, 45° angle
4-1/2" (11.4 cm)



FT-18-1114

GRADLE Cilia Forceps

1.4 mm wide precision ground jaws, smooth
4" (10.2 cm)



FT-18-1116

FORCEPS



BERKE Ptosis Forceps
longitudinal serrations, slide lock,
4" (10.2 cm), blades 27 mm long
4" (10.2 cm), blades 20 mm long



FT-18-1138

FT-4323 (not shown)

ERHARDT Lid Forceps
serrated jaws 9.5 mm wide
3-1/2" (8.9 cm)



FT-1150

SNELLEN Entropium Forceps
35 mm wide plate
3-3/4" (9.5 cm), left



FT-1160

SNELLEN Entropium Forceps
35 mm wide plate
3-3/4" (9.5 cm), right



FT-1162

BAIRD Chalazion Forceps
oval, inside ring 8 x 11 mm, small
4" (10.2 cm)



FT-1171

FORCEPS

AYER Chalazion Forceps
round, inside ring diameter 8.5 mm,
solid blade 8 mm diameter
3-1/2" (8.9 cm)



FT-18-1170

LAMBERT Chalazion Forceps
round, inside ring diameter 8 mm, outside diameter 11 mm
3-3/4" (9.5 cm)
3-1/2" (8.9 cm)



FT-18-1172



FT-18-1174

HUNT Chalazion Forceps
round, inside ring 12 mm
3-3/4" (9.5 cm)



FT-18-1178

HEATH Chalazion Forceps
oval, inside ring 12 x 14 mm
4" (10.2 cm)



FT-18-1182

SPENCER Chalazion Forceps
oval, inside ring 10 x 12 mm, with slide lock
4" (10.2 cm)

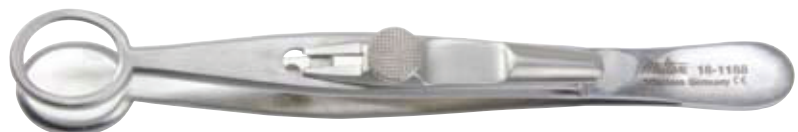

FT-18-1188

FORCEPS



WIES Chalazion Forceps
inside ring 9 x 12 mm
4" (10.2 cm)



FT-18-1190

DESMARRES Chalazion Forceps
3-1/2" (8.9 cm)
small, inside ring 11 x 17 mm
medium, inside ring 12 x 23 mm
large, inside ring 17 x 28 mm



FT-18-1200



FT-18-1202



FT-18-1204

FRANCIS Chalazion Forceps
oval, inside ring 12 x 14 mm
3-3/4" (9.5 cm)



FT-18-1208

PRINCE Trachoma Forceps
oval, inside ring 8 x 10 mm
3-1/2" (8.9 cm)
3-1/2" (8.9 cm), with set screw



FT-18-1220



FT-18-1220

JAMESON Recession & Muscle Forceps
with slide lock, 7 teeth, adult size
3-3/4" (9.5 cm), right
3-3/4" (9.5 cm), left



FT-18-1262



FT-18-1260

FORCEPS FIXATION



GRAEFTE Fixation Forceps

standard jaws 4.5 mm wide, with fine teeth
 4-3/8" (11.2 cm), no lock
 4-3/8" (11.2 cm), no lock, non-magnetic
 4-3/8" (11.2 cm), with lock



FT-18-850
FT-18-852 (not shown)



FT-18-854

WALDEAU Fixation Forceps

concave jaws 5 mm wide, with fine teeth
 4-3/8" (11.2 cm)



FT-18-860

VON GRAEFE Tissue Forceps

fine multiple atraumatic teeth
 4-1/4" (10.8 cm)



FT-6200

CASTROVIEJO (ALVIN) Fixation Forceps

1 x 1 curved teeth extending beyond each other
 3-3/4" (9.5 cm), straight



FT-18-876

CASTROVIEJO Fixation Forceps

2 x 2 curved teeth extending beyond each other
 3-3/4" (9.5 cm), straight



FT-18-878

GREEN Fixation Forceps, T-Shape

4" (10.2 cm)
 12 mm jaws, 19 x 20 teeth
 5 mm jaws, 8 x 9 teeth



FT-18-896



FT-18-897

FORCEPS FIXATION



O'BRIEN Fixation Forceps
delicate 1 x 2 teeth, angled forward
4" (10.2 cm), 0.9 mm wide

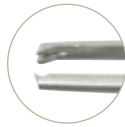

FT-18-904

ELSCHNIG Fixation Forceps
strong 1 x 2 teeth, angled forward
4-1/4" (10.8 cm), 0.9 mm wide

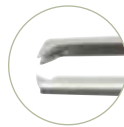

FT-18-906

LESTER Fixation Forceps
3-3/4" (9.5 cm)
delicate 1 x 2 teeth, 0.6 mm wide
delicate 2 x 3 teeth, 1.0 mm wide

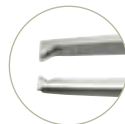

FT-18-912

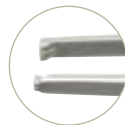

FT-18-914

HARMON Fixation Forceps
4 x 5 teeth, delicate 2.5 mm wide jaws
3" (7.6 cm)



FT-18-916

KIRBY Fixation Forceps
1 x 2 teeth, with slide lock
4" (10.2 cm), straight



FT-18-628

FORCEPS



NUGENT Utility Forceps

4-1/4" (10.8 cm)
smooth jaws, 1.2 mm
angled cross serrated jaws, 1.2 mm



FT-18-956



FT-18-958

McCULLOUGH Utility Forceps

4" (10.2 cm)
smooth jaws, 1.5 mm
straight cross serrated jaws, 1.5 mm



FT-18-962



FT-18-964

McCULLOUGH Suturing Forceps

1 x 2 teeth with cross serrated jaws
4" (10.2 cm), 1.5 mm



FT-18-966

KURTH Suture Forceps

smooth tying platform
4" (10.2 cm)



FT-4136

WILLS HOSPITAL Utility Forceps

cross serrated tying platform
4" (10.2 cm), 1.2 mm



FT-18-970

FORCEPS



BONNACCOLTO Utility Forceps

longitudinal serrations with cross serrations on jaws, 1.2 mm wide with tapered tips
4" (10.2 cm)



FT-18-971

SCHAAF Foreign Body Forceps

grooved jaws, octagonal handle
3-3/4" (9.5 cm)



FT-18-978

THORPE Corneal & Splinter Forceps

very sharp points, fine serrated jaws
4-1/2" (11.4 cm)



FT-18-980

ADSON Dressing Forceps

delicate, serrated
4-3/4" (12.1 cm), straight
4-3/4" (12.1 cm), angled



FT-6-118



FT-6-118



FT-6-118a

ADSON Dressing Forceps

delicate, serrated, lightweight
fenestrated handles
4-3/4" (12.1 cm), straight

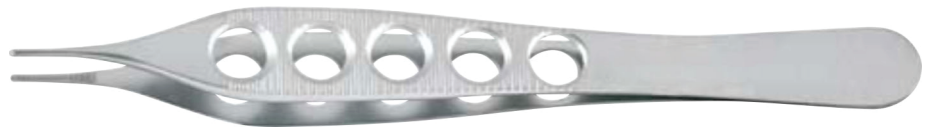

FT-6-118XI



FORCEPS



Micro ADSON Dressing Forceps
serrated
4-3/4" (12.1 cm), 0.5 mm



FT-17-2510

ADSON Dressing Forceps
delicate
4-3/4" (12.1 cm), cross serrated
4-3/4" (12.1 cm), smooth



FT-6105



FT-6106

ADSON Tissue Forceps
1 x 2 teeth, delicate
4-3/4" (12.1 cm), straight
4-3/4" (12.1 cm), angled



FT-6-120



FT-6-120a

ADSON Tissue Forceps
1 x 2 teeth, delicate, lightweight
fenestrated handles
4-3/4" (12.1 cm)



FT-6-120XI

Micro ADSON Tissue Forceps
1 x 2 teeth
4-3/4" (12.1 cm), 0.5 mm

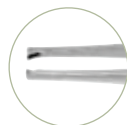

FT-17-2500

FORCEPS



ADSON Tissue Forceps

1 x 2 teeth, cross serrated tips, delicate
4-3/4" (12.1 cm), straight
4-3/4" (12.1 cm), angled



FT-6-121
FT-6121 (not shown)

ADSON Dressing, Tissue & Suture Forceps

1 x 2 teeth, with tying platform
4-3/4" (12.1 cm)



FT-6-123

ADSON Dressing, Tissue & Suture Forceps

1 x 2 teeth, with tying platform, lightweight
fenestrated handles
4-3/4" (12.1 cm)

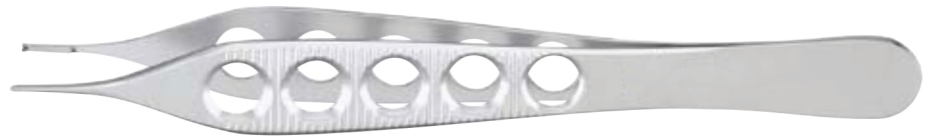

FT-6-123XI

ADSON Dissecting Forceps

fine 1 x 2 teeth, narrow lightweight handles
4-3/4" (12.1 cm)



FT-0278



FT-6-122

ADSON Tissue Forceps

2 x 3 teeth, delicate
4-3/4" (12.1 cm)
4-3/4" (12.1 cm), with serrations



FT-6115

FORCEPS



BROWN-ADSON Tissue Forceps

7 x 7 side grasping teeth
4-3/4" (12.1 cm), straight
4-3/4" (12.1 cm), angular

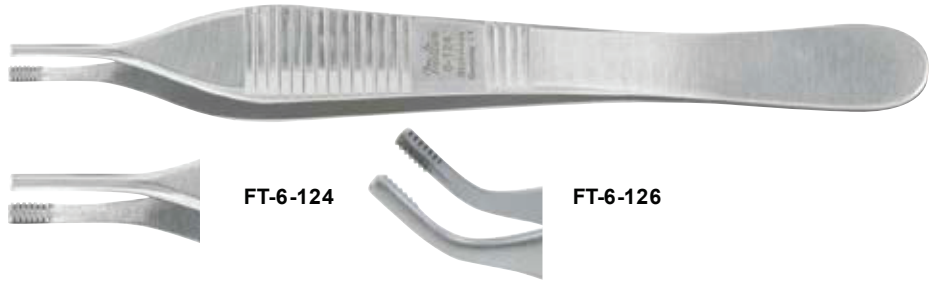

BROWN-ADSON Tissue Forceps

7 x 7 teeth side grasping teeth,
lightweight fenestrated handles
4-3/4" (12.1 cm)

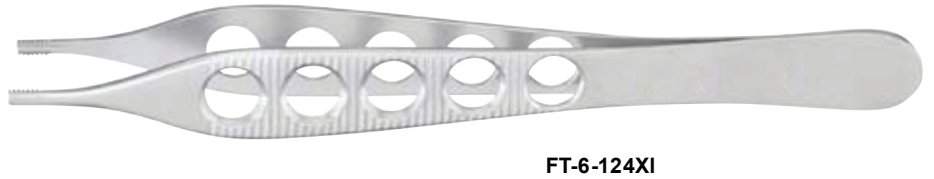

BROWN-ADSON Tissue Forceps

9 x 9 teeth side grasping teeth
4-3/4" (12.1 cm), straight
4-3/4" (12.1 cm), angled

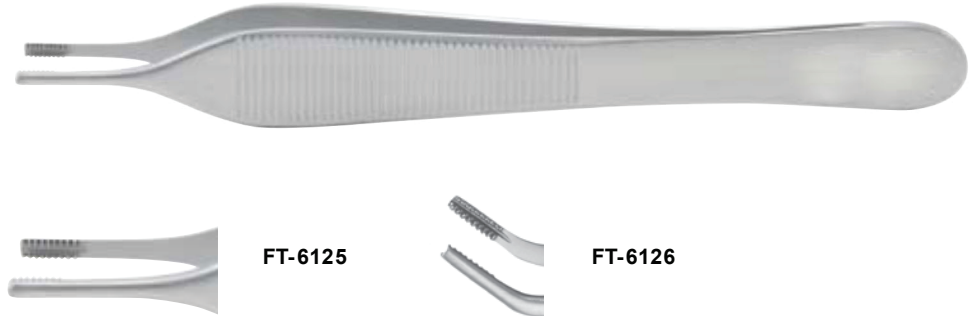

GRIFFITHS-BROWN Tissue Forceps

delicate, 1.5 x 5 mm Brown-Type teeth
4-1/4" (10.8 cm)



DeBAKEY-ADSON Tissue Forceps

atraumatic jaws, 1.5 mm
4-3/4" (12.1 cm)



FORCEPS



SEMKEN Dressing Forceps
serrated
5" (12.7 cm)



SEMKEN Tissue Forceps
1 x 2 teeth
5" (12.7 cm), straight
5" (12.7 cm), curved



LUCAE Dressing Forceps
bayonet shape, serrated jaws
5-1/2" (14.0 cm)



JANSEN Dressing Forceps
bayonet shape, extra delicate with
2 mm wide serrated jaws
6-1/4" (15.9 cm)



JANSEN Dressing Forceps
bayonet shape, serrated
6-1/2" (16.5 cm)



FORCEPS



GRAUL Tissue Forceps
very delicate 1 x 2 teeth, 0.5 mm
4" (10.2 cm)



FT-4842

LISTER Dissecting Forceps
1 x 2 teeth on grooved block jaws
4" (10.2 cm)



FT-0326

OLMSTEAD Tissue Forceps
delicate 1 x 2 teeth
2-3/4" (7.0 cm)

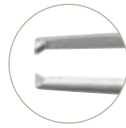

FT-4719

FELD Blepharoplasty Forceps
delicate, 9 x 9 Brown-Type teeth
4-1/4" (10.8 cm)

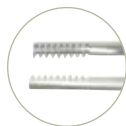

FT-4681

GRAZER Blepharoplasty Forceps
4 x 5 in-line teeth
4-1/4" (10.8 cm)



FT-6245

FORCEPS



ADSON Bipolar Forceps
4-1/4" (108 mm)
needle
0.5 mm



FT-9410



FT-9411

Jeweler's Bipolar Forceps
4-1/4" (10.8 cm)
needle
0.5 mm



FT-9420



FT-9421

Jeweler's Bipolar Forceps
curved
4-3/4" (12.1 cm), 1.0 mm



FT-9425

Bayonet Bipolar Forceps
6-1/2" (16.5 cm), 0.5 mm



FT-9430

Bayonet Bipolar Forceps
6-1/2" (16.5 cm), 1.0 mm



FT-9431

FORCEPS



Bipolar Instrument Cable
reusable, autoclavable, silicone
10 feet (305 cm)

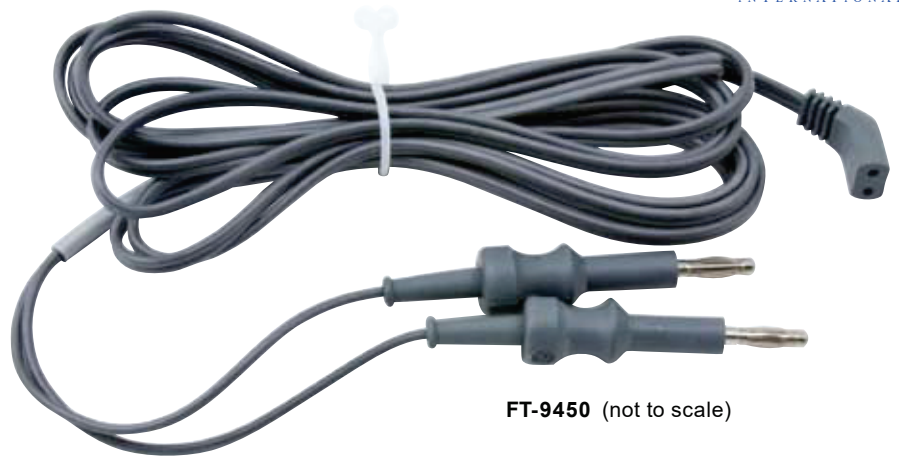

FT-9450 (not to scale)

Bipolar Instrument Cable
sterile, disposable, 10/box
12 feet (360 cm)

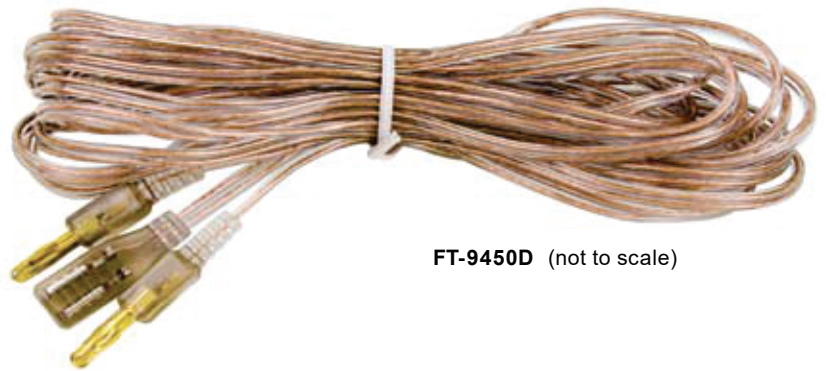

FT-9450D (not to scale)

WATZKE Sleeve Spreading Forceps
4-3/4" (12.1 cm), angled jaws



FT-015999

HEMOSTATS & CLAMPS



HEMOSTATICS & CLAMPS

HARTMAN Mosquito Forceps

4" (10.2 cm), straight
4" (10.2 cm), curved



JACOBSON Micro Mosquito Forceps

extremely delicate
5" (12.7 cm), straight
5" (12.7 cm), curved

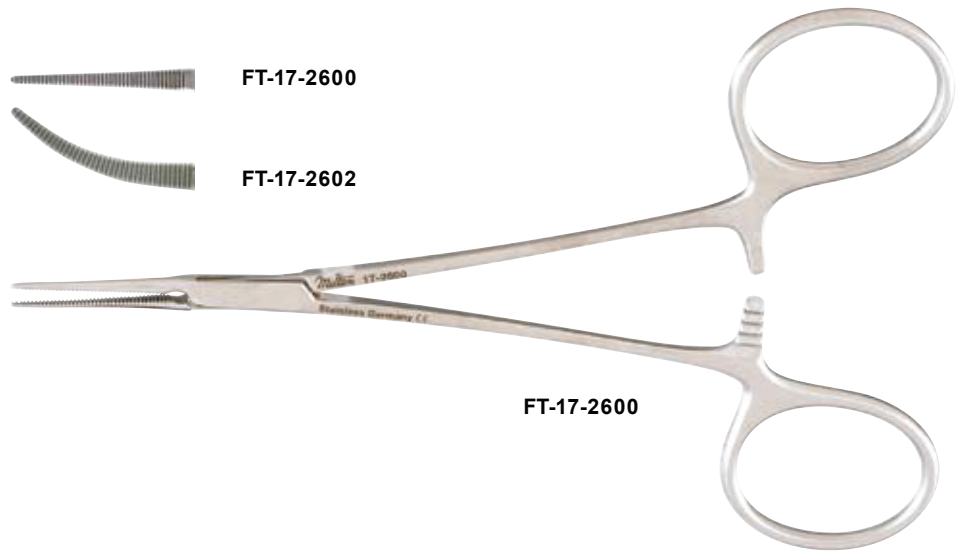
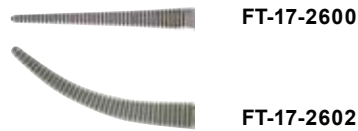

HALSTED Mosquito Forceps

non-magnetic
5" (12.7 cm), straight
5" (12.7 cm), curved

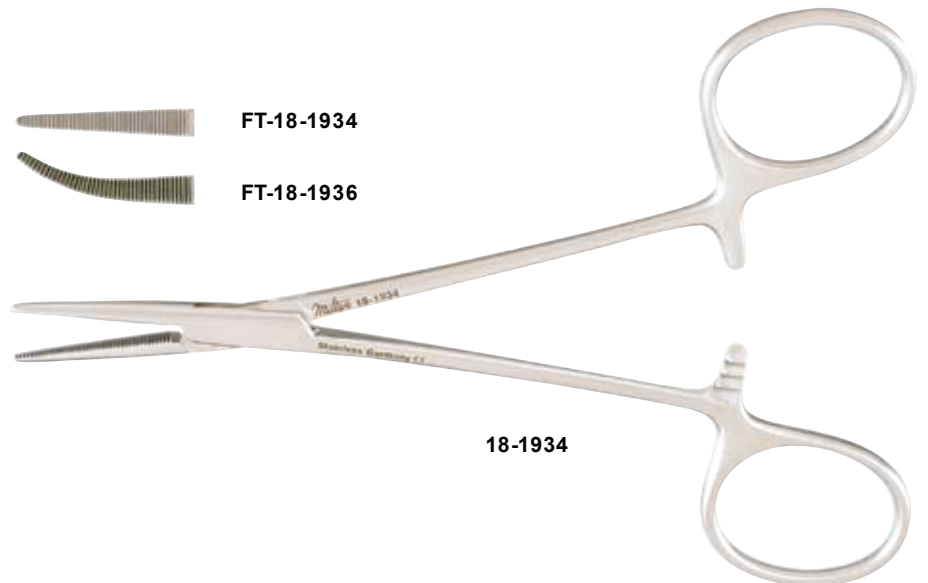

HEMOSTATICS & CLAMPS



HALSTED Mosquito Forceps
extra delicate
5" (12.7 cm), straight
5" (12.7 cm), curved

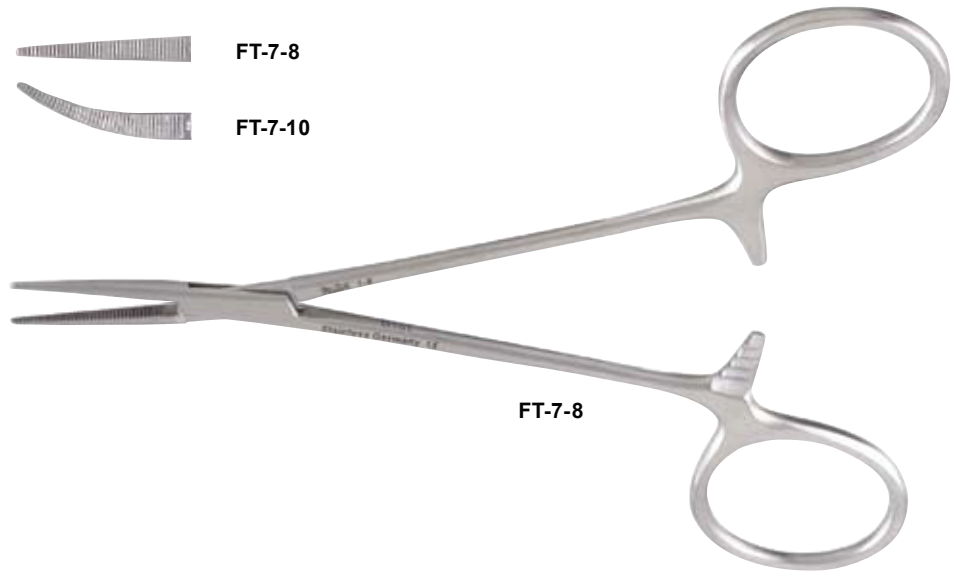

FT-7-8

HALSTED Mosquito Forceps
5" (12.7 cm), straight
5" (12.7 cm), curved



FT-7-2

JONES Towel Clamp
3-1/2" (8.9 cm)
2-1/4" (5.7 cm)



FT-7-500



FT-7-501

HEMOSTATICS & CLAMPS



BACKHAUS Towel Clamp

3-1/2" (8.9 cm)
5-1/4" (13.3 cm)



FT-7-504
FT-7-506 (not shown)

LORNA Non-Perforating Towel Clamp

4" (10.2 cm)
5-1/4" (13.3 cm)

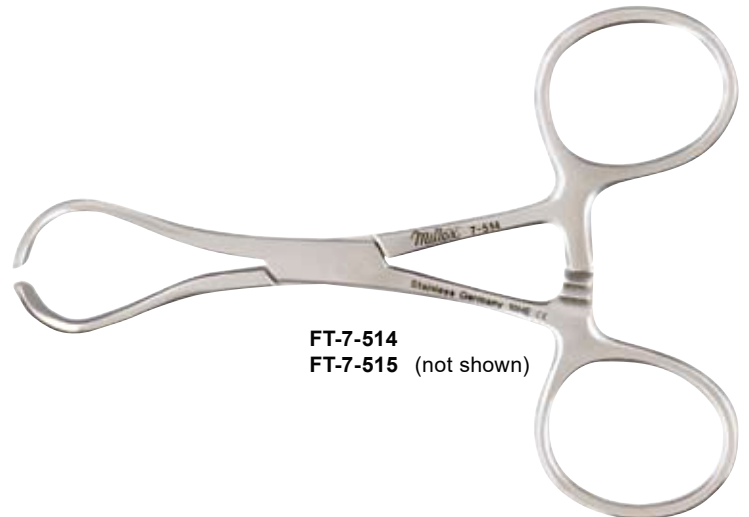

FT-7-514
FT-7-515 (not shown)

JOHNS HOPKINS Bulldog Clamp

1-1/2" (3.8 cm), straight
2" (5.1 cm), straight
2-1/2" (6.4 cm), straight
3" (7.6 cm), straight



FT-7-280



FT-7-282



FT-7-284



FT-7-286

JOHNS HOPKINS Bulldog Clamp

- 1-1/2" (3.8 cm), curved
- 2" (5.1 cm), curved
- 2-1/2" (6.4 cm), curved
- 3" (7.6 cm), curved
- 3-1/2" (8.9 cm), curved



FT-7-290



FT-7-292



FT-7-294



FT-7-296



FT-7-298

DIEFFENBACH Serrefine

- 2-1/4" (5.7 cm), straight
- 2-1/4" (5.7 cm), curved
- 1-1/2" (3.8 cm), straight
- 1-1/2" (3.8 cm), curved



FT-7-300



FT-7-302



FT-7-304



FT-7-305

DIETHRICH Micro Bulldog Clamp

- jaws 8 x 1.2 mm
- 1-7/8" (4.7 cm), straight
- 1-3/4" (4.4 cm), angled



FT-7-310



FT-7-315

HEMOSTATICS & CLAMPS



Micro Vessel Clips

- straight, 0.75 x 4 mm jaws
- straight, 0.8 x 6 mm jaws
- straight, 1.0 x 8 mm jaws
- straight, 1.5 x 10 mm jaws
- slightly curved, 1.0 x 6 mm jaws
- fully curved, 1.0 x 6 mm jaws
- 45° angle, 1.0 x 6 mm jaws



Micro Clip Approximator Set

2 x 6 mm jaws, 15 mm spread



Applying Forceps for Micro Clips

- 5-3/4" (14.6 cm), with lock
- 5-1/2" (14.0 cm), with stop



FT-17-4100

FT-17-4102

SCHWARTZ Vessel Clip

- 1.7 x 8 mm jaws
- 1" (2.5 cm), straight
- 1" (2.5 cm), slightly angled
- 1" (2.5 cm), strong angled



FT-26-1041

FT-26-1042

FT-26-1043

SCHWARTZ Clip Applying Forceps

8" (20.3 cm)

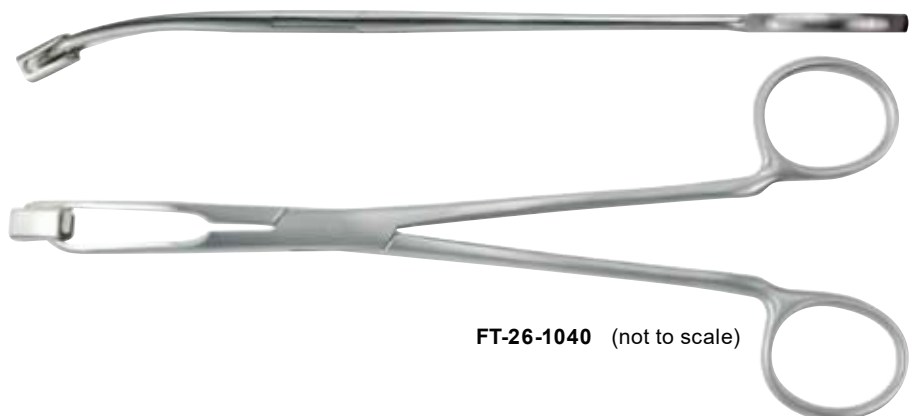

FT-26-1040 (not to scale)

SCISSORS



UTHOFF-GILLS Capsulotomy Scissors

10 mm long angled blades, curved and blunt tips
4-1/8" (10.5 cm)



FT-18-1616 (1/1)

GILLS Capsulotomy Scissors

10 mm long angled blades, curved and sharp tips
4-1/8" (10.5 cm)



FT-18-1617 (1/1)

VANNAS Capsulotomy Scissors

extra delicate blades with sharp tips,
triangular arrow shaped blades
3-1/4" (8.3 cm), straight
3-1/4" (8.3 cm), curved
3-1/4" (8.3 cm), angled to side
3-1/4" (8.3 cm), angled on flat



FT-18-1620



FT-18-1620 (1/1)



FT-18-1623 (1/1)



FT-18-1622 (1/1)



FT-18-1624 (1/1)

KATZIN Corneal Transplant Scissors

strong curve, medium blades
4-1/4" (10.8 cm), left
4-1/4" (10.8 cm), right



FT-18-1587 (1/1)



FT-18-1588 (1/1)



FT-18-1589 (1/1)



TROUTMAN-KATZIN Corneal Transplant Scissors

strong curve, small blades, with lock
4" (10.2 cm), left
4" (10.2 cm), right



FT-18-1590 (1/1)

SCISSORS



RICH Corneal Transplant Scissors
extremely delicate; strongly curved blades; for
trimming the recipient corneal bed and donor button;
can also be used for open sky anterior capsulotomy
4" (10.2 cm), left
4" (10.2 cm), right

 **FT-18-1591 (1/1)**



 **FT-18-1592 (1/1)**

CASTROVIEJO Corneoscleral Scissors
medium blades, curved
4-1/4" (10.8 cm), left
4-1/4" (10.8 cm), right

 **FT-18-1574 (1/1)**



 **FT-18-1575 (1/1)**

CASTROVIEJO Corneoscleral Scissors
small blades, curved
4-1/8" (10.5 cm), left
4-1/8" (10.5 cm), right

 **FT-18-1580 (1/1)**



 **FT-18-1579 (1/1)**

TROUTMAN-CASTROVIEJO Corneoscleral Scissors
small blades, curved, with lock
4" (10.2 cm), left
4" (10.2 cm), right

 **FT-18-1583 (1/1)**



 **FT-18-1584 (1/1)**

TROUTMAN-CASTROVIEJO Corneoscleral Scissors
medium blades, curved, with lock
4-1/4" (10.8 cm), left
4-1/4" (10.8 cm), right

 **FT-18-1585 (1/1)**



 **FT-18-1586 (1/1)**

SCISSORS



CASTROVIEJO Universal Corneal Scissors

curved, blunt tips
 4-1/8" (10.5 cm), small blades
 4-1/4" (10.8 cm), medium blades
 4-1/4" (10.8 cm), large blades

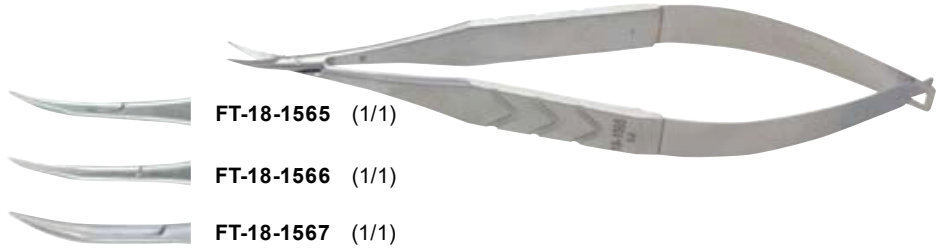

FT-18-1565 (1/1)

FT-18-1566 (1/1)

FT-18-1567 (1/1)

CASTROVIEJO Universal Corneal Scissors

strong curve, blunt tips, large blades
 4-1/4" (10.8 cm)



FT-18-1568 (1/1)

CASTROVIEJO Corneal Scissors

for microsurgery, 6 mm curved blades, blunt tips
 4" (10.2 cm), left
 4" (10.2 cm), right

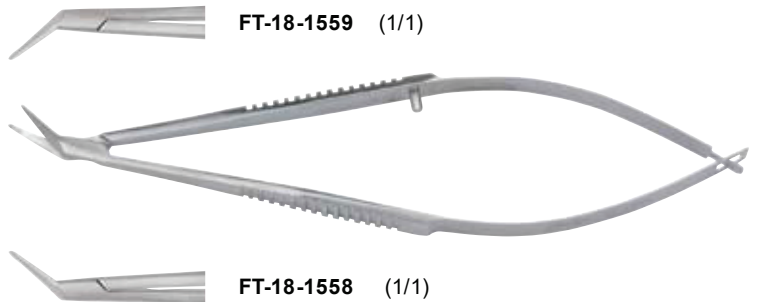

FT-18-1559 (1/1)

FT-18-1558 (1/1)

CASTROVIEJO Corneal Section Scissors

inner blade 1 mm longer, curved, blunt tips
 4-1/2" (11.4 cm), left
 4-1/2" (11.4 cm), right

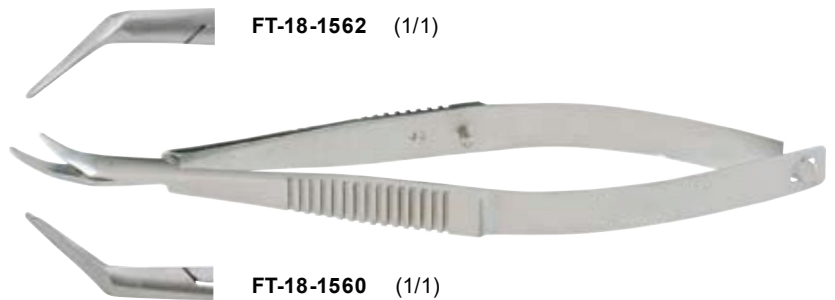

FT-18-1562 (1/1)

FT-18-1560 (1/1)

CASTROVIEJO Corneal Scissors

angled blades 11 mm
 3-3/4" (9.5 cm), blunt tips (corneal)
 3-3/4" (9.5 cm), sharp tips (keratoplasty)

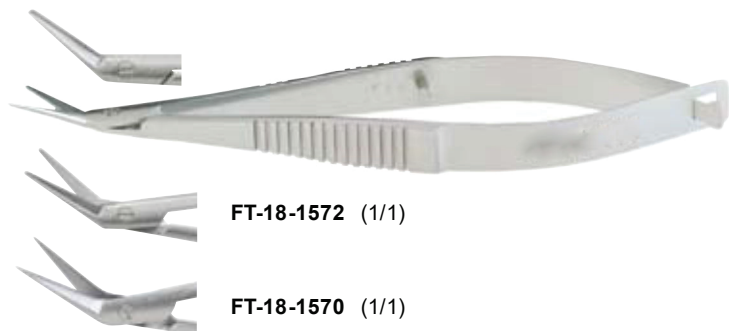

FT-18-1572 (1/1)

FT-18-1570 (1/1)

SCISSORS



CASTROVIEJO Corneal Scissors
 3-3/4" (9.5 cm), curved, sharp tips
 3-3/4" (9.5 cm), curved, blunt tips

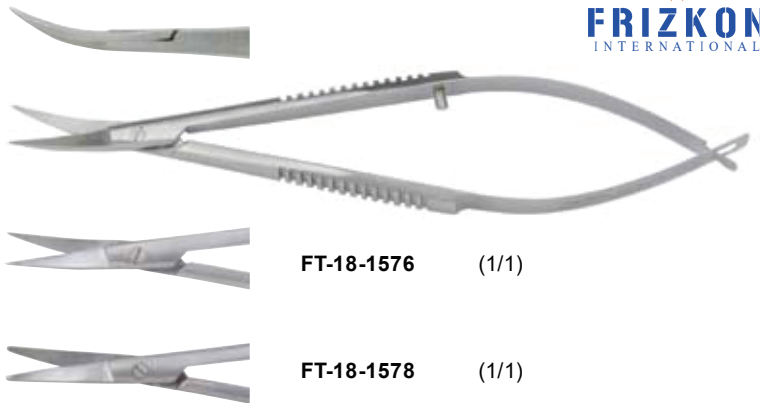

FT-18-1576 (1/1)

FT-18-1578 (1/1)

McGUIRE Corneal Scissors
 curved, blunt tips
 4-1/8" (10.5 cm), right
 4-1/8" (10.5 cm), left

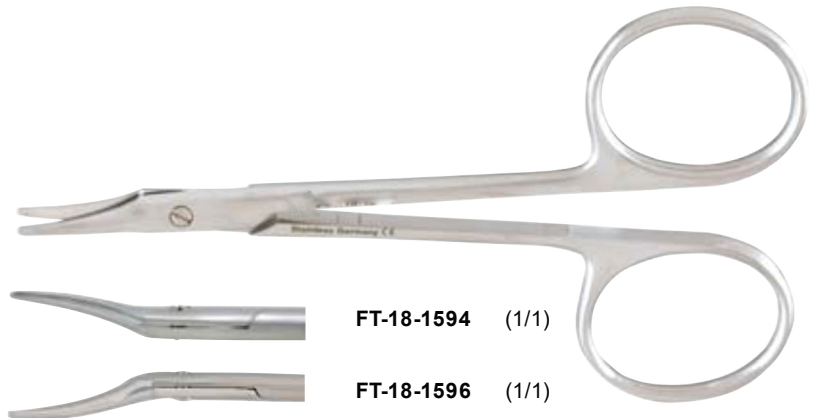

FT-18-1594 (1/1)

FT-18-1596 (1/1)

AEBLI Corneal Scissors
 blunt tips
 4" (10.2 cm), straight
 4" (10.2 cm), angled on flat, right
 4" (10.2 cm), angled on flat, left

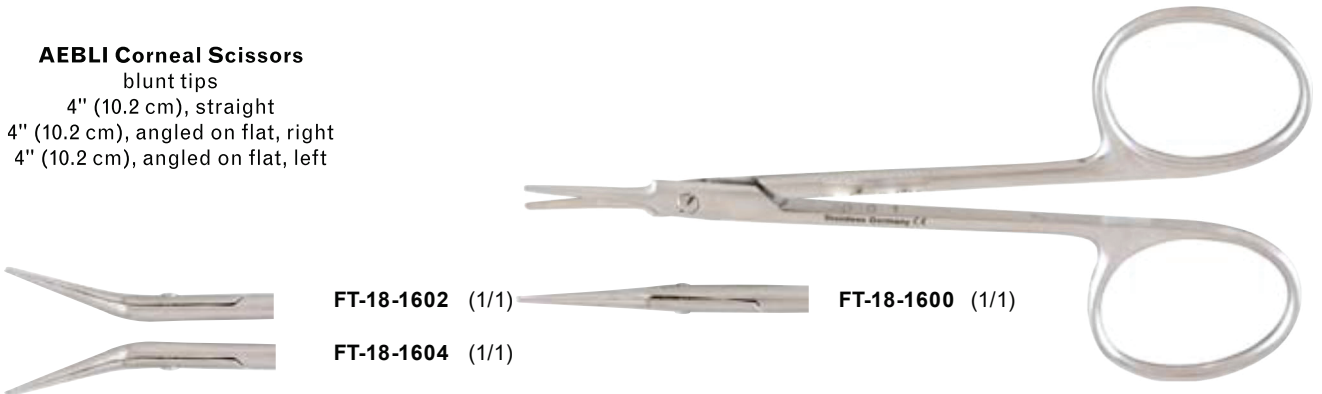

FT-18-1602 (1/1)

FT-18-1604 (1/1)

FT-18-1600 (1/1)

McPHERSON-WESTCOTT Conjunctival Scissors
 small blades, blunt tips
 4-1/8" (10.5 cm), curved

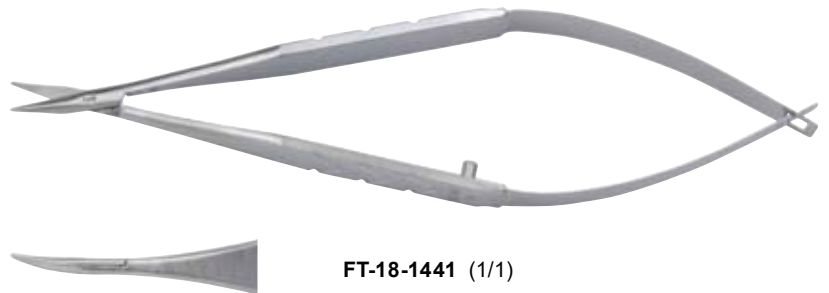

FT-18-1441 (1/1)

SCISSORS



WILMER (CONVERSE) Conjunctival Scissors

angled on flat, semi-sharp tips
 4-1/8" (10.5 cm), flattened thin blades
 4-1/4" (10.8 cm), saber-back blades



WILMER (CONVERSE) Conjunctival and Utility Scissors

angled on flat, semi-sharp tips
 4" (10.2 cm), flattened thin blades



WILMER (CONVERSE) Conjunctival & Utility Scissors, Tungsten Carbide

angled on flat, long blades, semi-sharp tips
 4-1/2" (11.4 cm), flattened thin blades

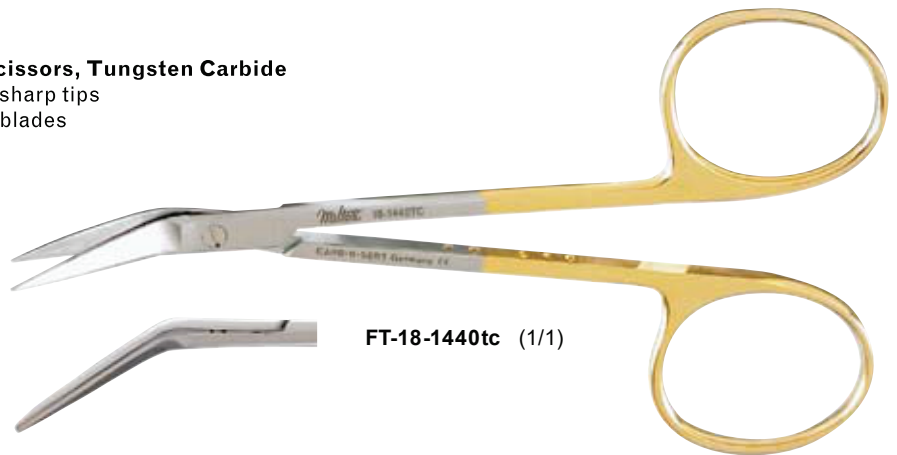

ENUCLEATION Scissors

rounded blades, blunt tips
 5 (12.7 cm), light curve
 5 (12.7 cm), medium curve
 5 (12.7 cm), full curve



SCISSORS



CASTROVIEJO Keratoplasty Scissors

medium blades, blunt tips
4-1/4" (10.8 cm), angled to side



FT-18-1581 (1/1)

CASTROVIEJO Corneal Scissors

angled blades 11 mm
3-3/4" (9.5 cm), blunt tips (corneal)
3-3/4" (9.5 cm), sharp tips (keratoplasty)

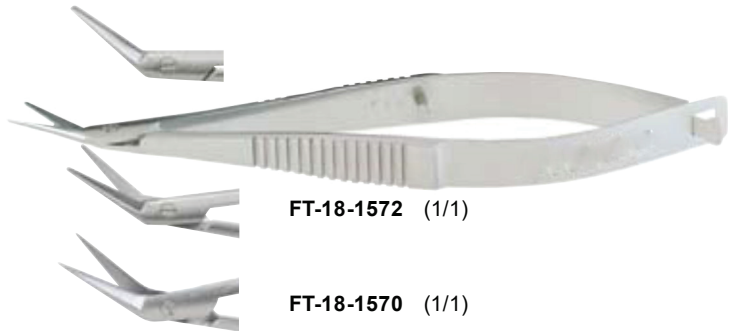

FT-18-1572 (1/1)

FT-18-1570 (1/1)

STRABISMUS Scissors

ribbon type, rounded blades, blunt tips
4-1/4" (10.8 cm), straight
4-1/4" (10.8 cm), curved

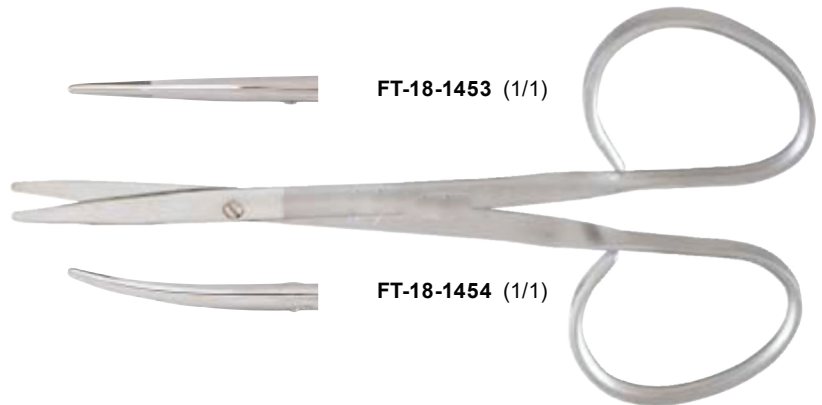

FT-18-1453 (1/1)

FT-18-1454 (1/1)

PADGETT Strabismus Scissors

ribbon type, rounded blades, blunt tips
4-1/8" (10.5 cm), straight
4-1/8" (10.5 cm), curved

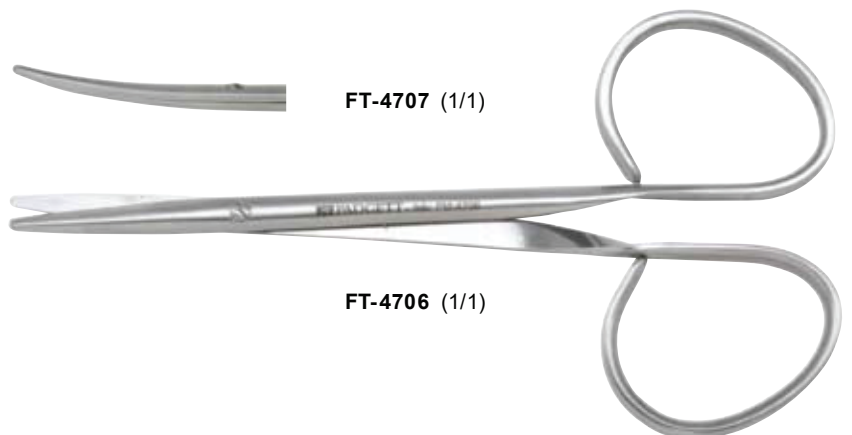

FT-4707 (1/1)

FT-4706 (1/1)

SCISSORS



STRABISMUS Scissors

rounded blades, blunt tips
4" (10.2 cm), straight
4" (10.2 cm), curved



FT-5-314 (1/1)

FT-5-312 (1/1)

STRABISMUS Scissors, Tungsten Carbide

rounded blades, blunt tips
4-1/2" (11.4 cm), straight
4-1/2" (11.4 cm), curved

4-1/2" (11.4 cm), straight
4-1/2" (11.4 cm), curved

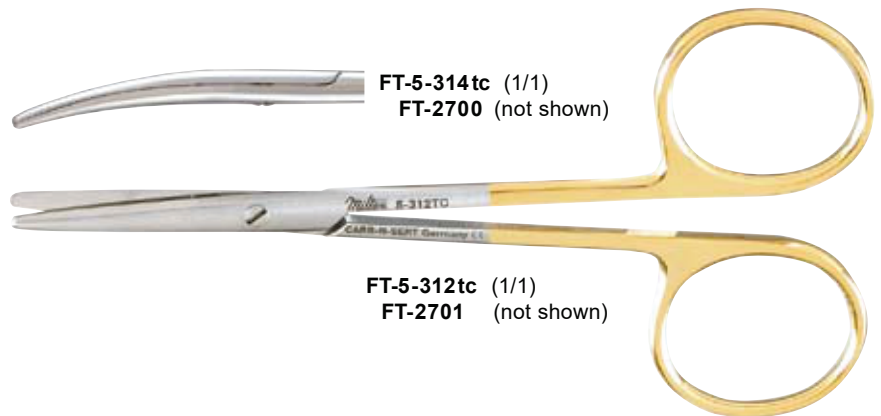

FT-5-314tc (1/1)

FT-2700 (not shown)

FT-5-312tc (1/1)

FT-2701 (not shown)

STEVENS Tenotomy Scissors

blunt tips, ribbon type
3-3/4" (9.5 cm), straight
3-3/4" (9.5 cm), curved

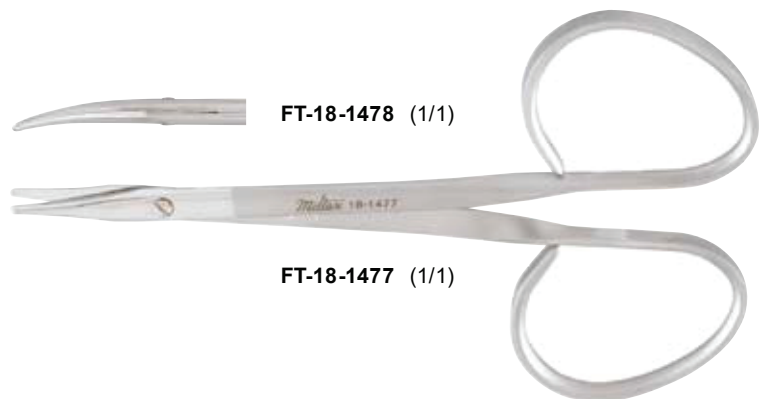

FT-18-1478 (1/1)

FT-18-1477 (1/1)

PADGETT-STEVENS Tenotomy Scissors

blunt tips, ribbon type
3-3/4" (9.5 cm), straight
3-3/4" (9.5 cm), curved

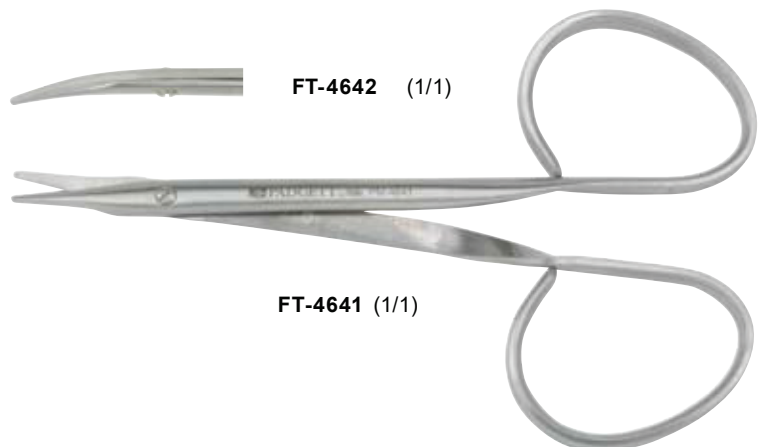

FT-4642 (1/1)

FT-4641 (1/1)

SCISSORS



STEVENS Tenotomy Scissors

short blades

4-1/8" (10.5 cm), straight, sharp tips
4-1/8" (10.5 cm), curved, sharp tips

4-1/8" (10.5 cm), straight, blunt tips
4-1/8" (10.5 cm), curved, blunt tips



FT-18-1464 (1/1)
FT-18-1466



FT-18-1460 (1/1)



FT-18-1462

STEVENS Tenotomy Scissors

long blades

4-1/2" (11.4 cm), straight, sharp tips
4-1/2" (11.4 cm), curved, sharp tips

4-1/2" (11.4 cm), straight, blunt tips
4-1/2" (11.4 cm), curved, blunt tips



FT-18-1474 (1/1)
FT-18-1476



FT-18-1470 (1/1)



FT-18-1472

STEVENS Tenotomy Scissors, SuperCut

long blades, one micro fine serrated blade

4-1/2" (11.4 cm), straight, sharp tips
4-1/2" (11.4 cm), curved, sharp tips

4-1/2" (11.4 cm), straight, blunt tips
4-1/2" (11.4 cm), curved, blunt tips



FT-18-sc -1474 (1/1)
FT-18-sc-1476



FT-18-sc -1470(1/1)



FT-18-sc-1472

STEVENS Tenotomy Scissors, SuperCut

long blades, one micro fine serrated blade

4-1/2" (11.4 cm), curved, semi-sharp tips



FT-6860 (1/1)



SCISSORS



STEVENS Tenotomy Scissors, Tungsten Carbide

long blades, semi-sharp tips
4-1/2" (11.4 cm), curved

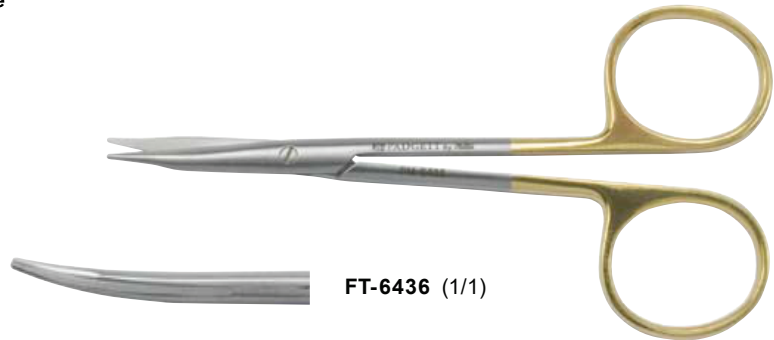

FT-6436 (1/1)

STEVENS Tenotomy Scissors, SuperCut & Tungsten Carbide Combination

long blades, blunt tips, one micro fine serrated blade
4-1/2" (11.4 cm), curved

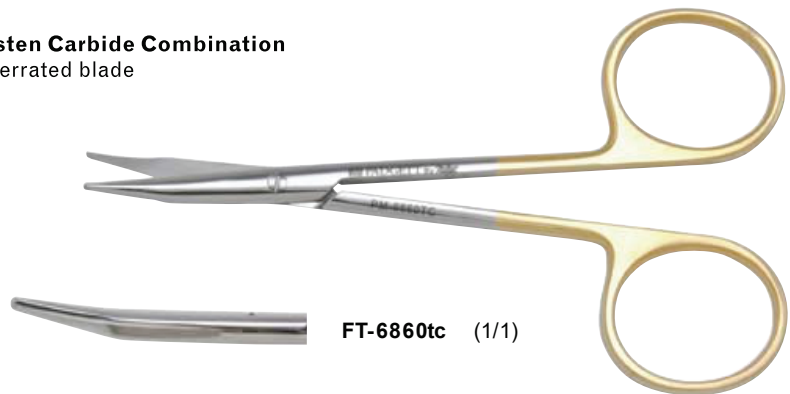

FT-6860tc (1/1)

PADGETT-STEVENS Tenotomy Scissors, Tungsten Carbide

long blades, sharp tips, one serrated blade
5" (12.7 cm), curved

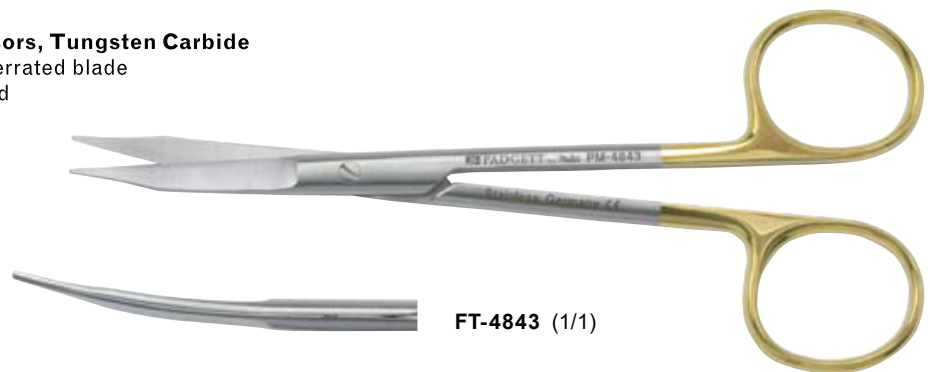

FT-4843 (1/1)

STEVENS Tenotomy Scissors

long blades, blunt tips
5-1/2" (14.0 cm), curved
6-1/4" (15.9 cm), curved

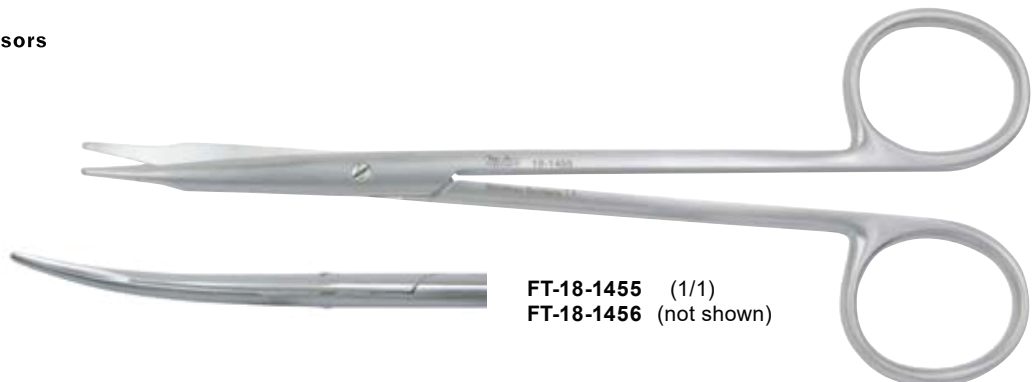

FT-18-1455 (1/1)
FT-18-1456 (not shown)

SCISSORS



WESTCOTT Tenotomy Scissors
medium blades, curved
4-1/2" (11.4 cm), blunt tips

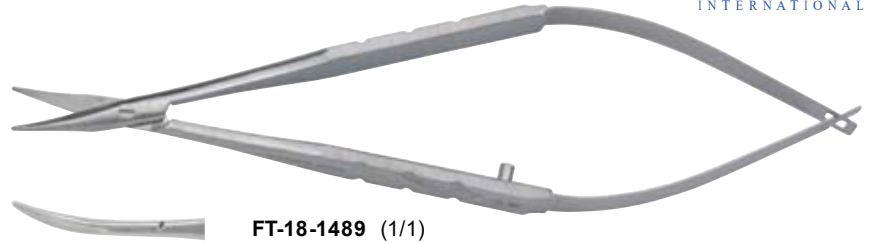

FT-18-1489 (1/1)

WESTCOTT Tenotomy Scissors
wide handles, curved, blunt tips
5-1/4" (13.3 cm), left
5-1/4" (13.3 cm), right



FT-18-1488 (1/1)



FT-18-1487 (1/1)

GRADLE Scissors
slightly curved
3-3/4" (9.5 cm), sharp tips

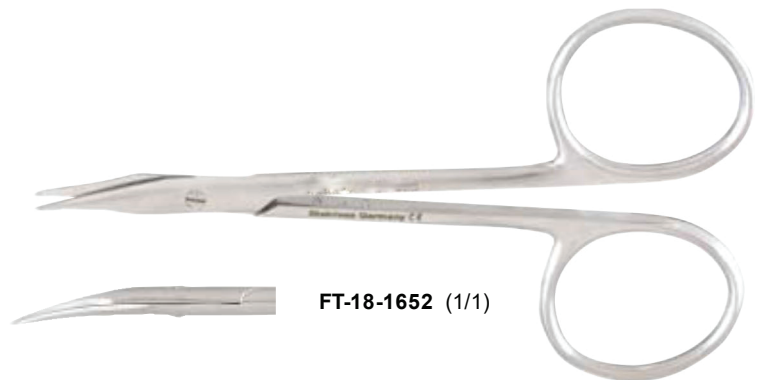

FT-18-1652 (1/1)

GRADLE Scissors, SuperCut
slightly curved, one micro fine serrated blade
3-3/4" (9.5 cm), blunt tips



FT-18-sc -1652(1/1)



SCISSORS

GRADLE Scissors, SuperCut
ribbon type, slightly curved, one micro fine
serrated blade
4" (10.2 cm), sharp tips

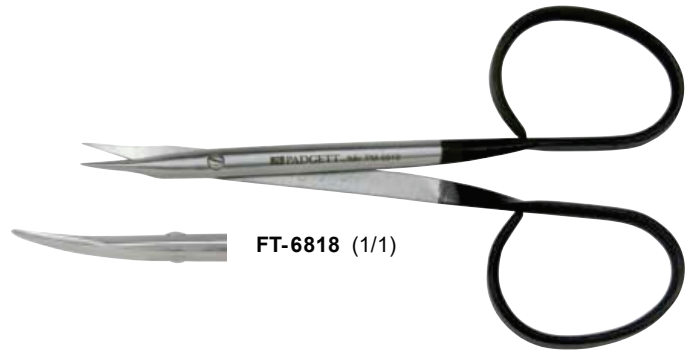

EYE SUTURE Scissors
ribbon type, slightly curved
4" (10.2 cm), sharp tips

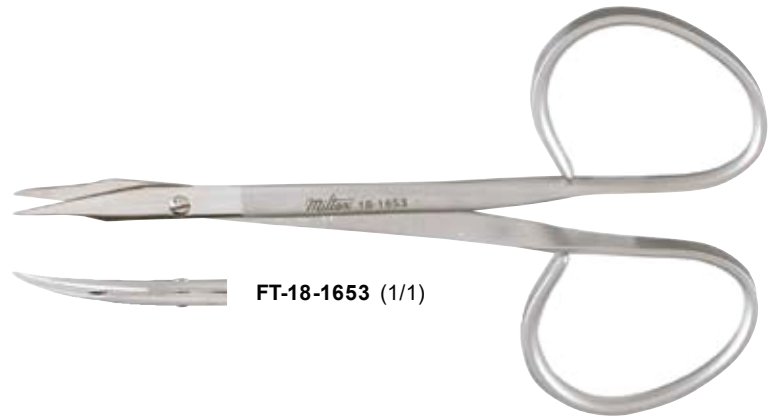

IRIS Scissors
sharp tips, small blades
4-1/8" (10.5 cm), straight
4-1/8" (10.5 cm), curved

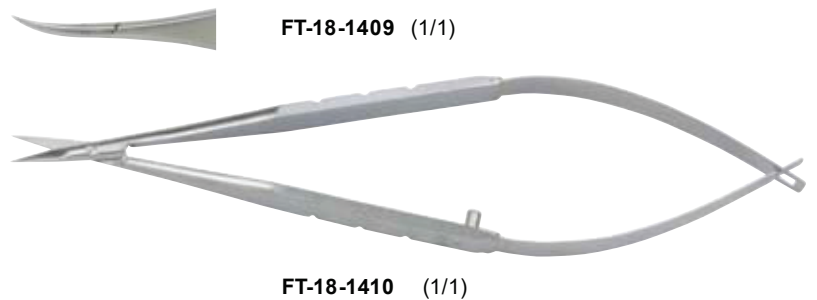

PADGETT Iris Scissors
ribbon type, delicate short blades, sharp tips
3-3/4" (9.5 cm), straight
3-3/4" (9.5 cm), curved

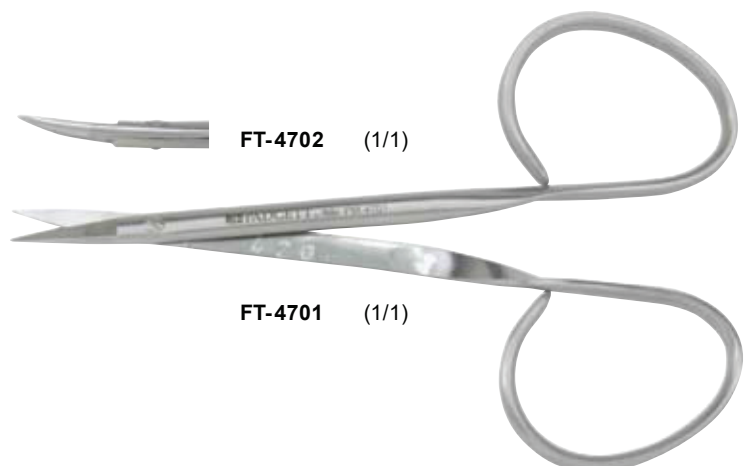

SCISSORS



PADGETT Iris Scissors
delicate long blades, sharp tips
3-3/4" (9.5 cm), straight
3-3/4" (9.5 cm), curved

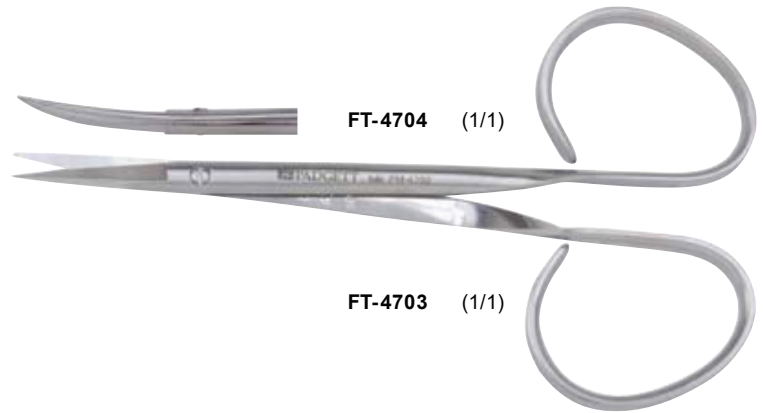

FT-4704 (1/1)

FT-4703 (1/1)



FT-18-1635 (1/1)

MILTEX-VANNAS Scissors
sharp tips, extra thin 7 mm long rounded blades
4" (10.2 cm), straight
4" (10.2 cm), curved



FT-18-1636 (1/1)



FT-18-1638 (1/1)

MILTEX-VANNAS Scissors
sharp tips, extra thin 10 mm long rounded blades
4-1/4" (10.8 cm), straight
4-1/4" (10.8 cm), curved



FT-18-1637 (1/1)

GILLS-VANNAS Scissors
sharp tips, extra thin 7 mm long rounded blades
4" (10.2 cm) angled forward

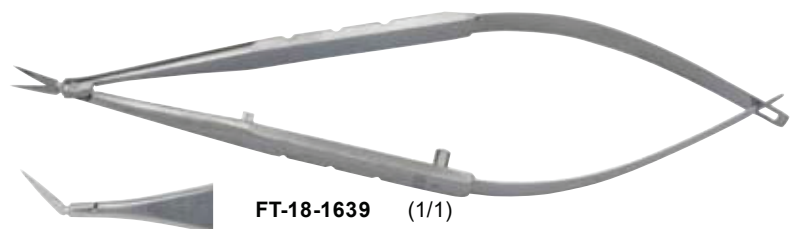

FT-18-1639 (1/1)

SCISSORS



McPHERSON-VANNAS Micro Iris Scissors

sharp tips
3-1/4" (8.3 cm), straight
3-1/4" (8.3 cm), curved



FT-18-1625 (1/1)



Micro VANNAS Scissors

sharp tips, ultrafine triangular arrow shaped blades
3-1/4" (8.3 cm), straight
3-1/4" (8.3 cm), curved



FT-18-1630 (1/1)



STERN-GILLS Scissors

sharp tips, extra thin 10 mm long rounded blades
4-1/8" (10.5 cm), straight, angled forward



FT-18-1640 (1/1)



URIBE-STERN Scissors

sharp tips, extra thin 10 mm long rounded blades
4-1/8" (10.5 cm), curved, angled forward



FT-18-1641 (1/1)

SCISSORS



NOYES Iris Scissors

straight

4-1/2" (11.4 cm), blunt/blunt tips

4-1/2" (11.4 cm), sharp/blunt tips

4-1/2" (11.4 cm), sharp/sharp tips



FT-18-1514 (1/1)



FT-18-1512 (1/1)



FT-18-1510 (1/1)

NOYES (ROSS) Iris Scissors

curved

4-1/2" (11.4 cm), sharp/sharp tips



FT-18-1516 (1/1)



PADGETT Iris Scissors

4-1/2" (11.4 cm), straight, sharp/blunt tips

4-1/2" (11.4 cm), curved, sharp/blunt tips

4-1/2" (11.4 cm), straight, blunt/blunt tips

4-1/2" (11.4 cm), curved, blunt/blunt tips



FT-4249 (1/1)

FT-4246 (1/1)

FT-4247 (1/1)

FT-4250 (1/1)



BARRAQUER Iris Scissors

7 mm blades, angled

2-1/4" (5.7 cm), sharp tips

2-1/4" (5.7 cm), blunt tips



FT-18-1520 (1/1)

FT-18-1521 (not shown)

SCISSORS

DeWECKER Iris Scissors

7 mm blades, sharp tips
4-1/4" (10.8 cm), angled



FT-18-1524 (1/1)

McCLURE Iris Scissors

4 mm blades with delicate sharp tips
3-3/4" (9.5 cm), angled to side



FT-18-1550 (1/1)

McCLURE Iris Scissors

delicate 4 mm blades with sharp tips
3-3/4" (9.5 cm), angled on flat

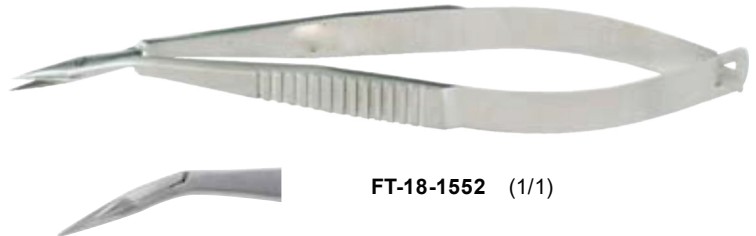

FT-18-1552 (1/1)

McCLURE Iris Scissors

regular 10 mm blades with sharp tips
4-1/2" (11.4 cm), angled on flat



FT-18-1554 (1/1)

SCISSORS



MICRO Iris Scissors
sharp tips
4" (10.2 cm), straight
4" (10.2 cm), curved

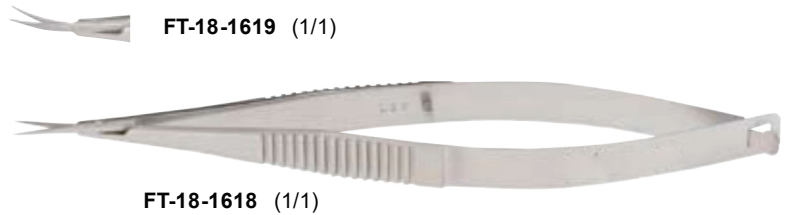

MICRO Scissors
super fine blades
3-1/4" (8.3 cm), straight
3-1/4" (8.3 cm), curved

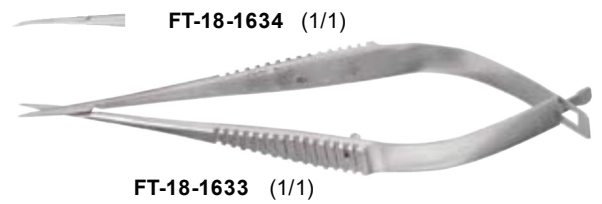

Aphrodite® Iris Scissors
heavy pattern
4" (10.2 cm), straight
4" (10.2 cm), curved

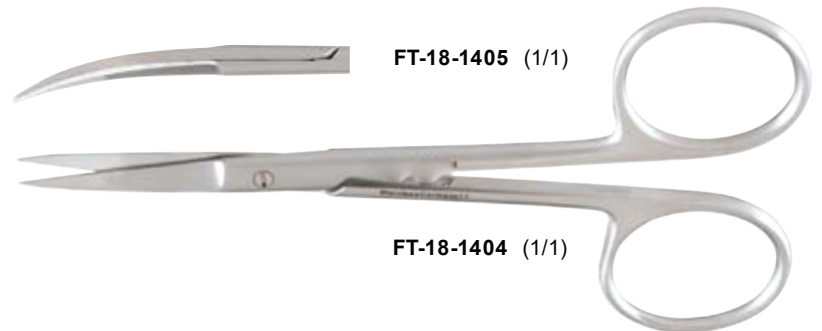

PADGETT Iris Scissors, Tungsten Carbide
sharp tips, rounded blades
4-1/2" (11.4 cm), straight
4-1/2" (11.4 cm), curved

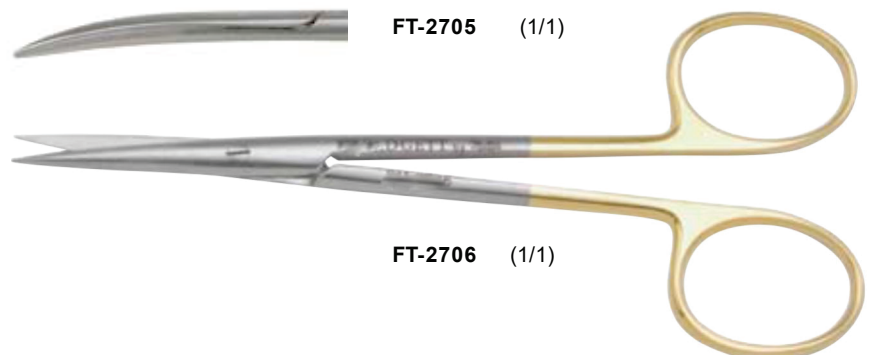

SCISSORS

IRIS Scissors
ribbon type, standard pattern, sharp tips
4" (10.2 cm), straight
4" (10.2 cm), curved



FT-18-1416 (1/1)

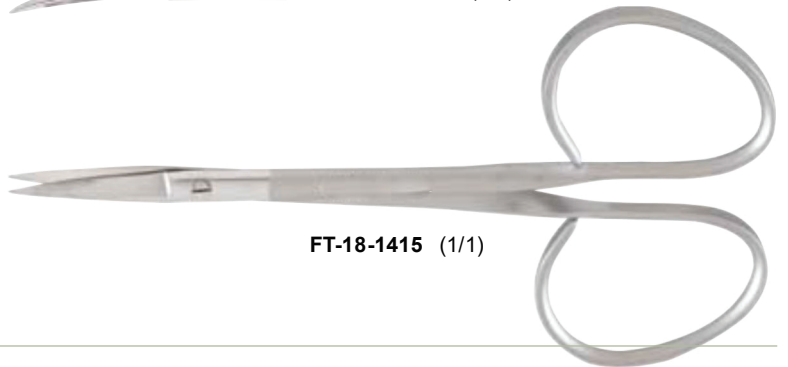

FT-18-1415 (1/1)

IRIS Scissors
ribbon type, miniature pattern with 14 mm blades, sharp tips
3-3/4" (9.5 cm), straight
3-3/4" (9.5 cm), curved



FT-18-1418 (1/1)

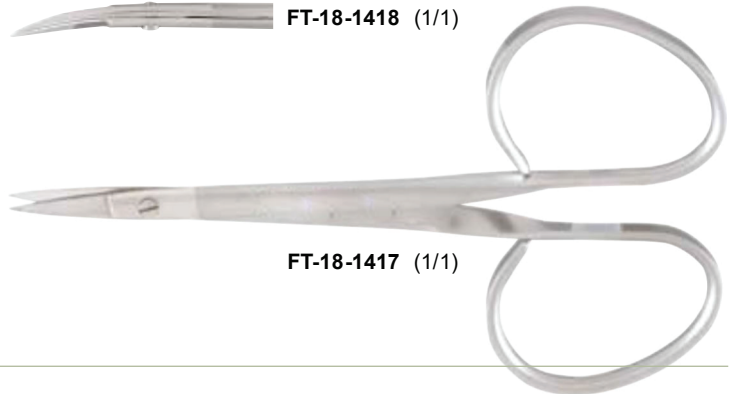

FT-18-1417 (1/1)

IRIS Scissors
delicate, with 20 mm blades, sharp tips
3-1/2" (8.9 cm), straight
3-1/2" (8.9 cm), curved



FT-18-1398 (1/1)



FT-18-1396 (1/1)

IRIS Scissors
sharp tips
4" (10.2 cm), straight
4" (10.2 cm), curved



FT-5-302 (1/1)

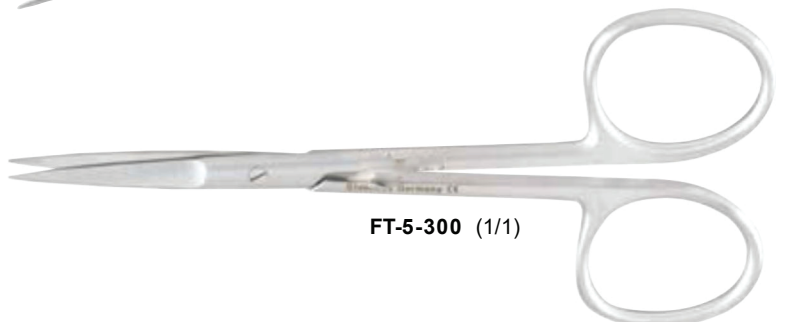

FT-5-300 (1/1)

SCISSORS



IRIS Scissors
4-1/2" (11.4 cm), straight
4-1/2" (11.4 cm), curved
4-1/2" (11.4 cm), angled on side

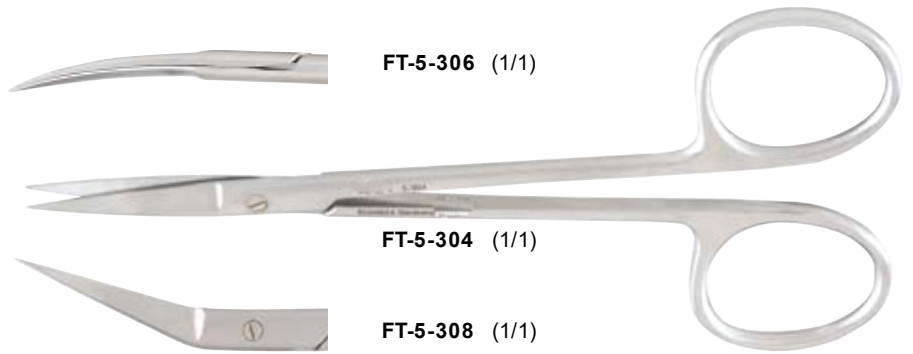

FT-5-306 (1/1)

FT-5-304 (1/1)

FT-5-308 (1/1)

IRIS Scissors, Tungsten Carbide
4-1/2" (11.4 cm), straight
4-1/2" (11.4 cm), curved

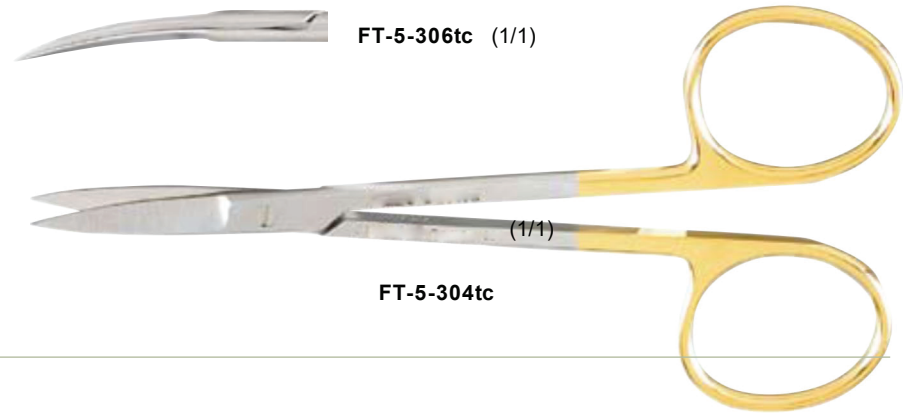

FT-5-306tc (1/1)

(1/1)

FT-5-304tc

IRIS Scissors, SuperCut
one micro fine serrated blade
4-1/2" (11.4 cm), straight
4-1/2" (11.4 cm), curved
4-1/2" (11.4 cm), straight



FT-5-sc -306 (1/1)

FT-5-sc -304(1/1)
pM-6815 (not shown)

IRIS Scissors, SuperCut & Tungsten Carbide
one micro fine serrated blade
4-1/2" (11.4 cm), straight
4-1/2" (11.4 cm), curved

4-1/2" (11.4 cm), straight
4-1/2" (11.4 cm), curved

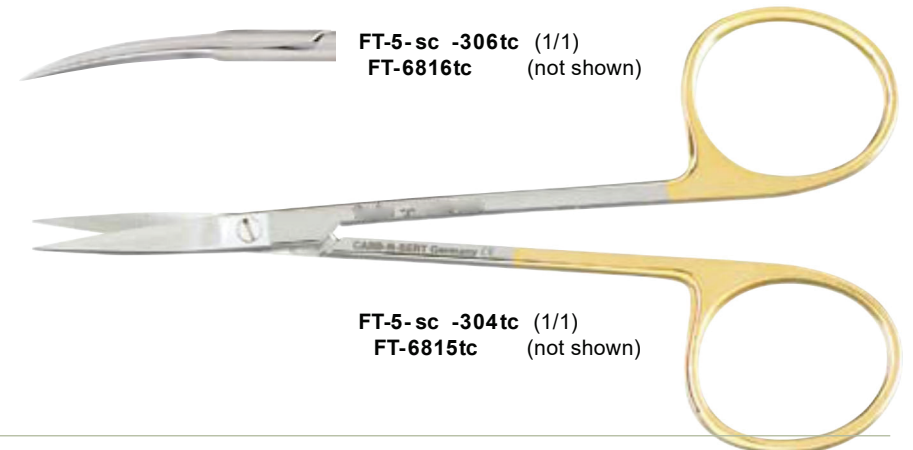

FT-5-sc -306tc (1/1)
FT-6816tc (not shown)

FT-5-sc -304tc (1/1)
FT-6815tc (not shown)

SCISSORS



IRIS Utility Scissors
ribbon type, 15 mm blades, blunt tips
3-3/4" (9.5 cm), curved

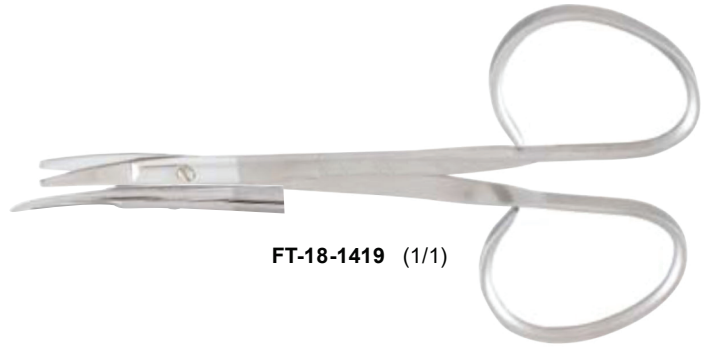

FT-18-1419 (1/1)

HOOD Iris Scissors, Tungsten Carbide
sharp tips, square shanks
4-1/2" (11.4 cm), straight
4-1/2" (11.4 cm), curved

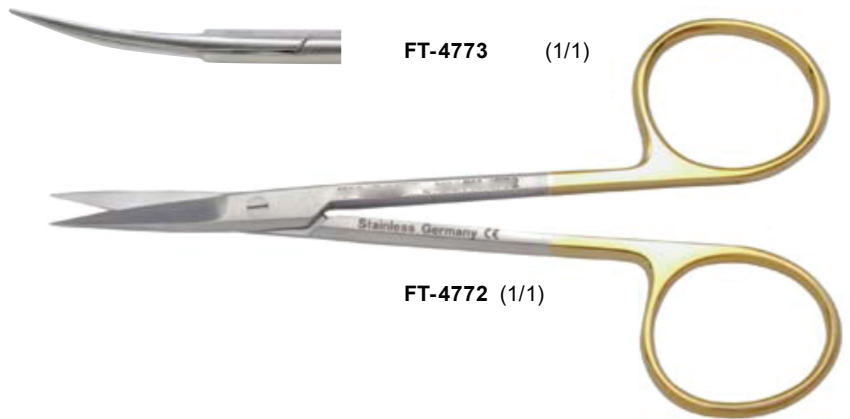

FT-4773 (1/1)

FT-4772 (1/1)

THOMAS Iris Scissors
delicate blades, semi-sharp tips
4-1/2" (11.4 cm), straight
4-1/2" (11.4 cm), curved

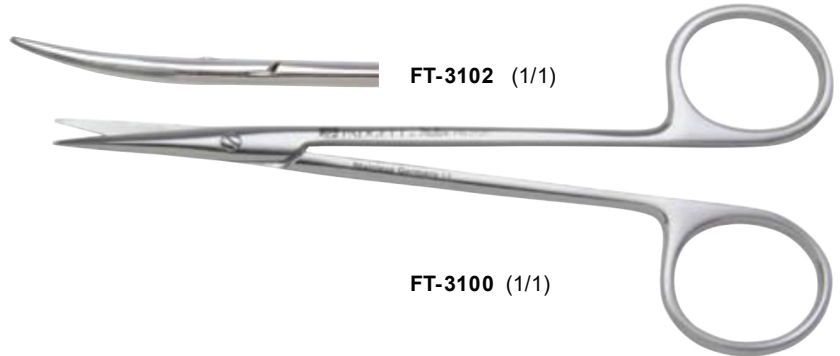

FT-3102 (1/1)

FT-3100 (1/1)

WALKER Iris Scissors
sharp tips
4-1/2" (11.4 cm), curved to side



FT-4635 (1/1)

SCISSORS



GRAUL Iris Scissors

delicate blades, sharp tips, large finger rings
4" (10.2 cm), straight
4" (10.2 cm), curved

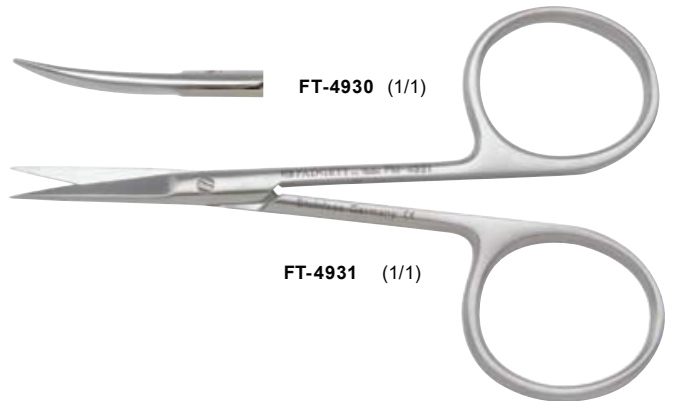

KNAPP Iris Scissors

4" (10.2 cm), straight, sharp/blunt tips
4" (10.2 cm), curved, sharp/blunt tips

4" (10.2 cm), straight, blunt/blunt tips
4" (10.2 cm), curved, blunt/blunt tips

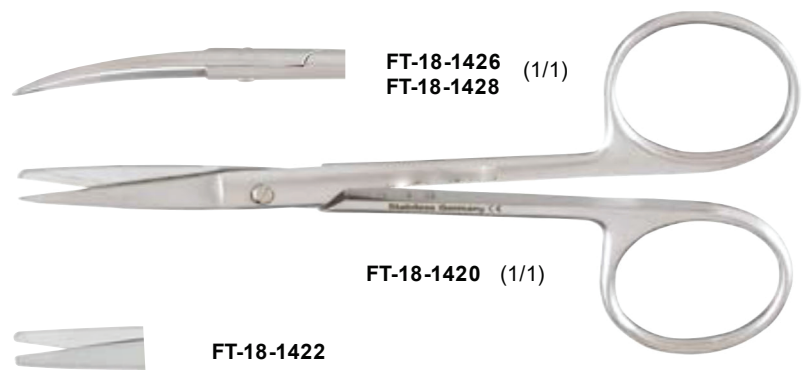

BONN Miniature Iris Scissors

with 15 mm blades, sharp tips
3-1/2" (8.9 cm), straight
3-1/2" (8.9 cm), curved

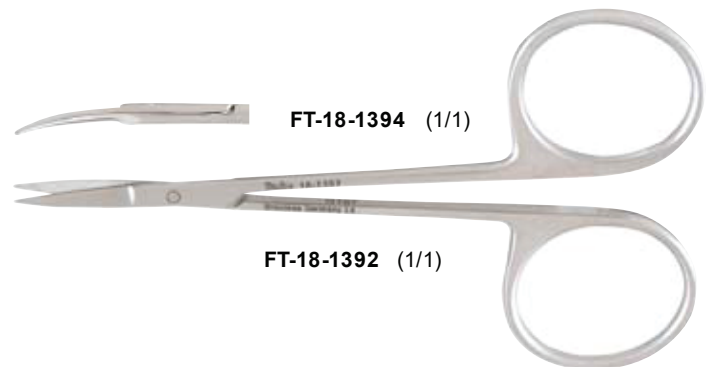

EYE Scissors

with probe tips
4" (10.2 cm), straight
4" (10.2 cm), curved

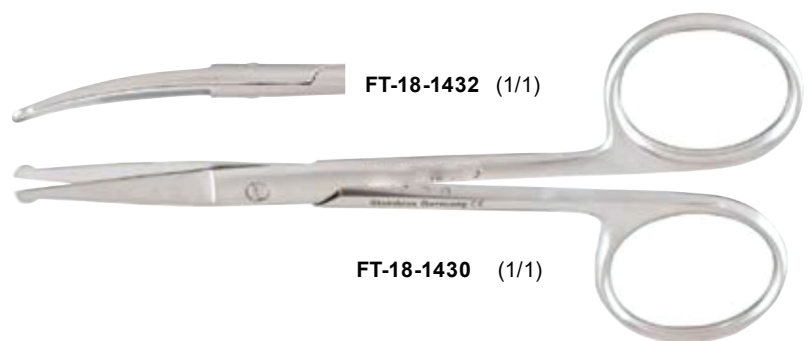

SCISSORS

EYE Scissors
with probe tips
4-1/2" (11.4 cm), angled on side

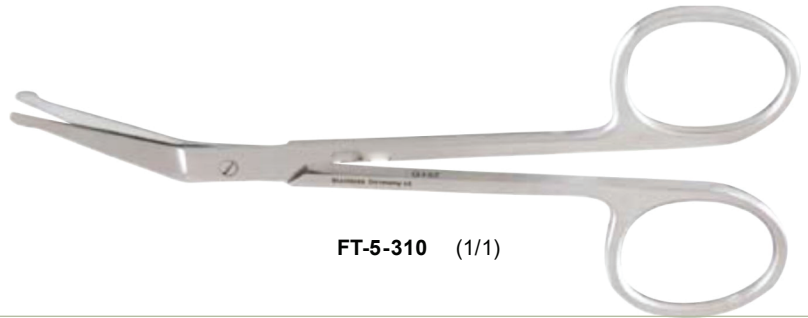

FT-5-310 (1/1)

IRIS Operating Scissors
sharp tips
4-1/2" (11.4 cm), curved sideways



FT-5D-303 (1/1)

JAFFE Stitch Scissors
very sharp pointed tips, medium rounded blades
4-1/4" (10.8 cm), curved

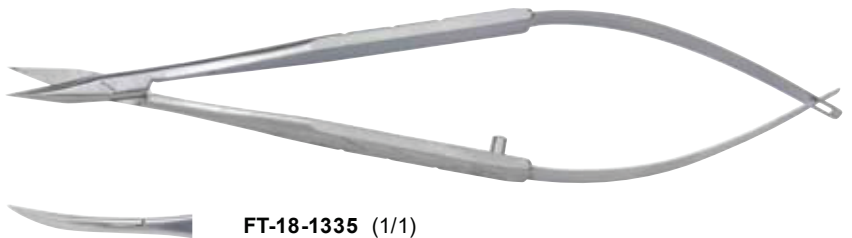

FT-18-1335 (1/1)

FINE Stitch Scissors
sharp tips, medium blades
4-1/2" (11.4 cm), straight
4-1/2" (11.4 cm), curved



FT-18-1433 (1/1)

SCISSORS



McPHERSON-WESTCOTT Stitch Scissors

very sharp tips, small blades
4-1/8" (10.5 cm), curved



EYE SUTURE (GRADLE) Scissors

sharp tips
3-3/4" (9.5 cm), slightly curved



EYE SUTURE (GRADLE) Scissors, SuperCut

blunt tips, one micro fine serrated blade
3-3/4" (9.5 cm), slightly curved



EYE Suture Scissors

ribbon type, sharp tips
4" (10.2 cm), slightly curved

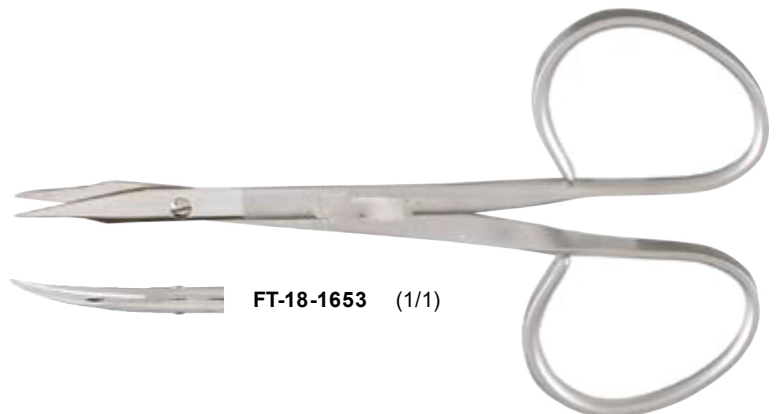

SCISSORS

HAYNES Suture Scissors

ribbon type, sharp tips
4-3/8" (11.1 cm), curved



PADGETT Suture/Stitch Scissors

ribbon type, short blades, curved
3-7/8" (9.8 cm), blunt tips, rounded blades
3-7/8" (9.8 cm), sharp tips, flat blades

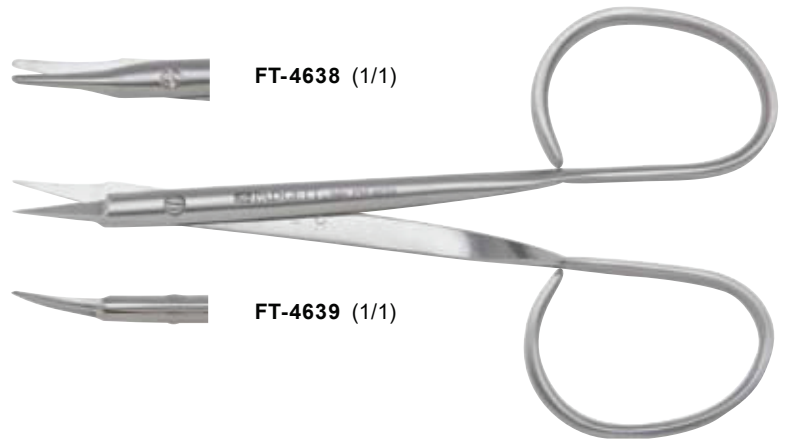

Aphrodite® Stitch Scissors

ribbon type, sharp tips
3-7/8" (9.8 cm), curved
4-1/2" (11.4 cm), curved

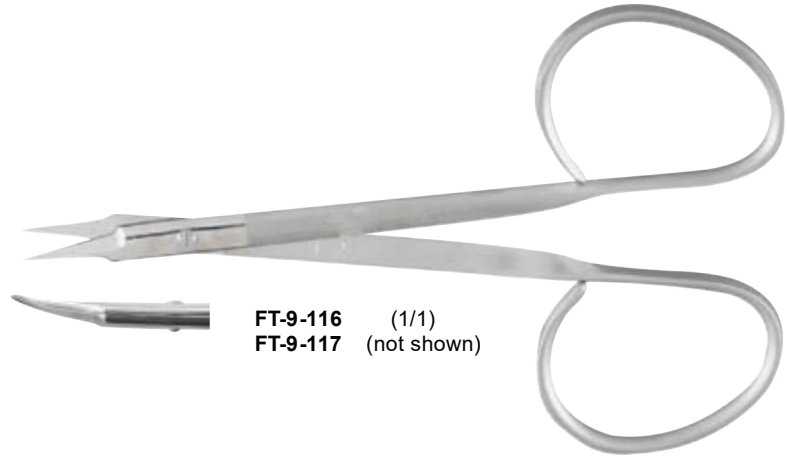

REEH Stitch Scissors

ribbon type, sharp tips with extra delicate
hook at the end of one blade
3-3/4" (9.5 cm)

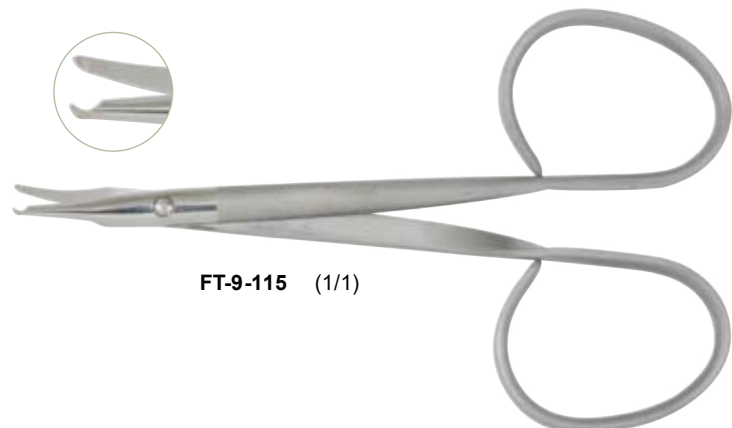

SCISSORS



SPENCER Stitch Scissors

delicate, with hook
3-1/2" (8.9 cm), straight

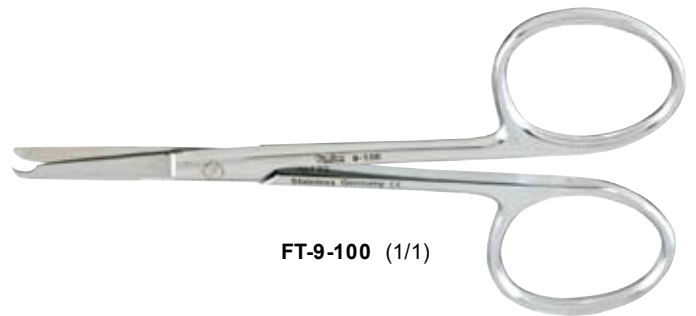

FT-9-100 (1/1)

SPENCER Stitch Scissors

delicate, with hook
3-1/2" (8.9 cm), curved on flat

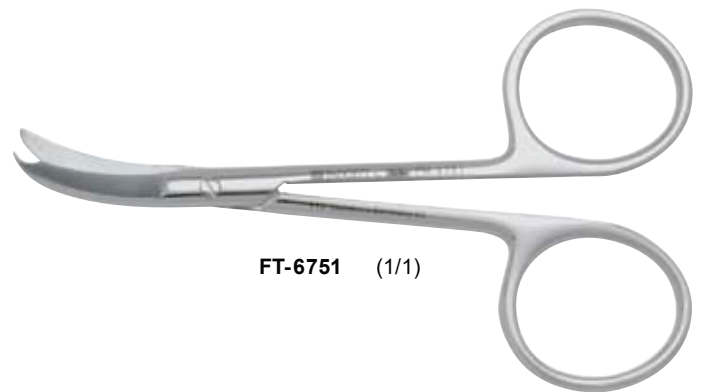

FT-6751 (1/1)

SHORTBENT Stitch Scissors

delicate, with hook
3-1/2" (8.9 cm), curved



FT-9-101 (1/1)

O'BRIEN Stitch Scissors

sharp tips
3-3/4" (9.5 cm), angled



FT-9-110 (1/1)

SCISSORS



HOOD Micro Stitch Scissors
sharp tips
4-1/2" (11.4 cm), curved

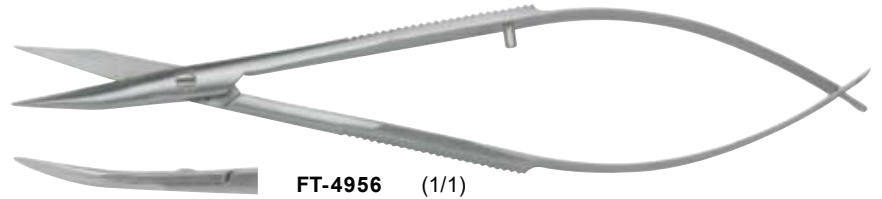

FT-4956 (1/1)

WESTCOTT Stitch Scissors
curved
4-1/2" (11.4 cm), sharp tips
4-1/2" (11.4 cm), blunt tips



FT-18-1480 (1/1)



FT-18-1486 (1/1)



FT-18-1486 (1/1)
FT-18-1480

Nawrooz® Utility Scissors
ribbon type, blunt tips
4" (10.2 cm), curved

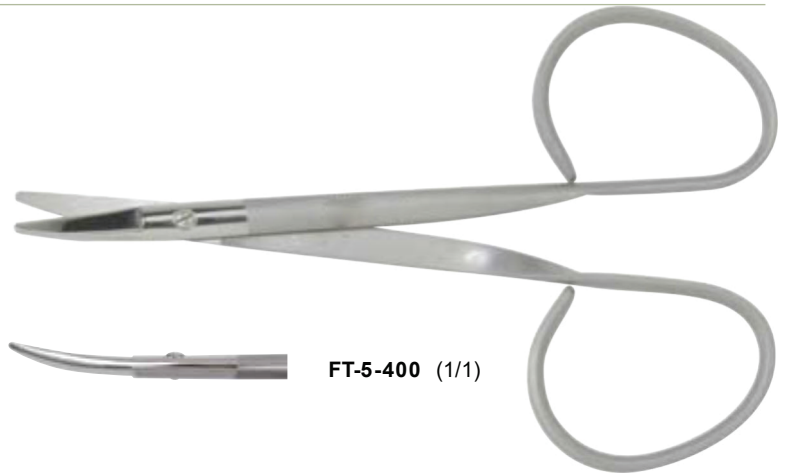

FT-5-400 (1/1)

MOSBY Utility Scissors
sharp tips
3-3/4" (9.5 cm), curved



FT-4718 (1/1)

SCISSORS



LA GRANGE Sclerectomy Scissors
sharp tips, one serrated blade, S-shape
4-1/4" (10.8 cm), curved



FT-5D-324 (1/1)

HOOD Micro Dissecting Scissors
sharp tips
4" (10.2 cm), straight
4" (10.2 cm), curved

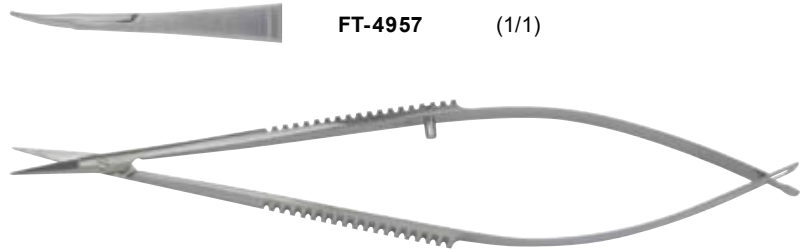

FT-4957 (1/1)

FT-4958 (1/1)

GOLDMAN-FOX Scissors
fine blunt tips, one serrated blade
5" (12.7 cm), curved



FT-5-320 (1/1)

GOLDMAN-FOX Scissors, Tungsten Carbide
fine blunt tips, one serrated blade
5" (12.7 cm), curved



FT-5-320tc (1/1)

SCISSORS



GOLDMAN-FOX Scissors, SuperCut
fine blunt tips, one micro fine serrated blade
5" (12.7 cm), curved



REYNOLDS Scissors, SuperCut
semi-sharp tips, one micro fine serrated blade
5" (12.7 cm), curved

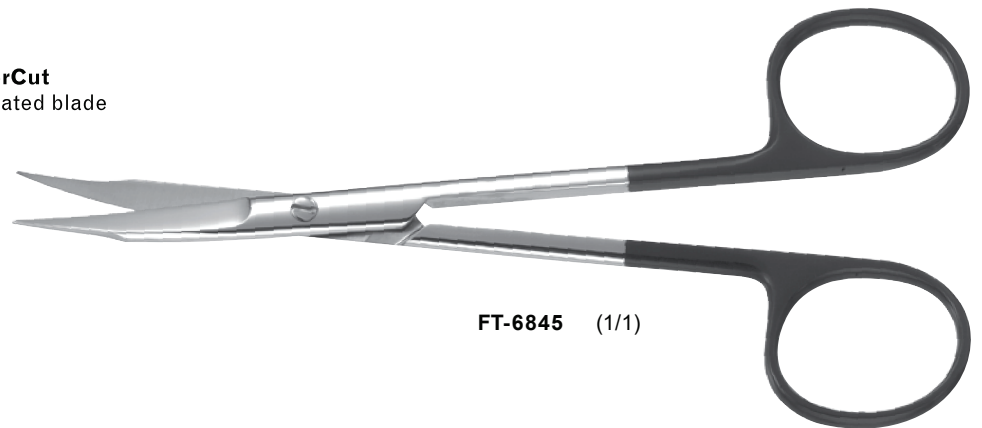

REYNOLDS Scissors, SuperCut & Tungsten Carbide
semi-sharp tips, one micro fine serrated blade
5" (12.7 cm), curved

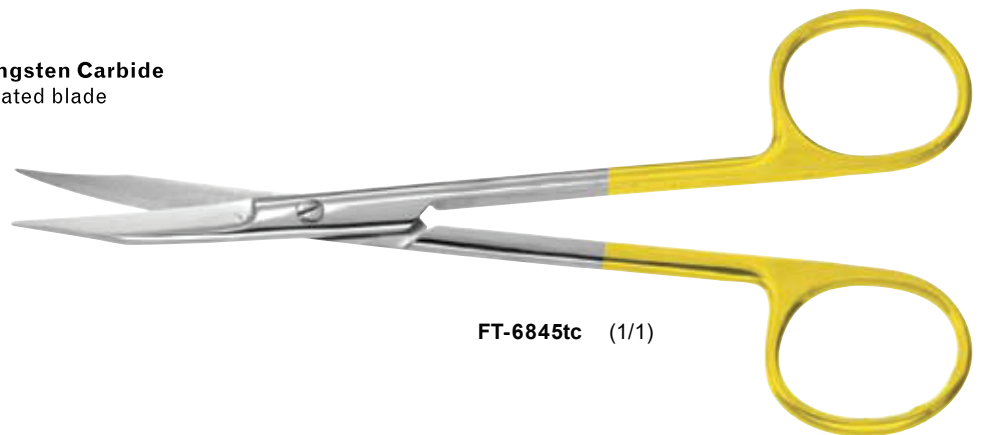

METZENBAUM Scissors
delicate
5" (12.7 cm), straight
5" (12.7 cm), curved

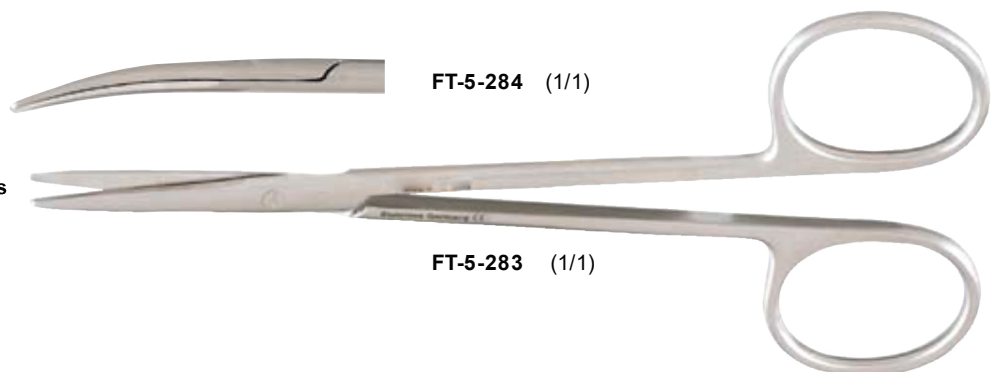

SCISSORS



METZENBAUM Scissors, SuperCut

delicate, one micro fine serrated blade
4-1/2" (11.4 cm), straight
4-1/2" (11.4 cm), curved



FT-5-sc -284(1/1)

FT-5-sc -283(1/1)

RAGNELL (KILNER) Scissors

blunt flattened tip
5" (12.7 cm), curved



FT-5-290 (1/1)

RAGNELL (KILNER) Scissors, SuperCut

blunt flattened tip, one micro fine serrated blade
5" (12.7 cm), curved



FT-5-sc -290(1/1)

PAR Tissue & Dissecting Scissors, SuperCut

delicate blades with blunt tips, one micro fine serrated blade
4-1/2" (11.4 cm), curved
4-1/2" (11.4 cm), curved
5-1/2" (14.0 cm), curved



FT-21-sc -745(1/1)

FT-6855 & FT-6856 (not shown)

SCISSORS

PAR Tissue & Dissecting Scissors, Tungsten Carbide

delicate blades with blunt tips
4-1/2" (11.4 cm), curved
5-3/4" (14.6 cm), curved



FT-2930 (1/1)
FT-2911 (not shown)

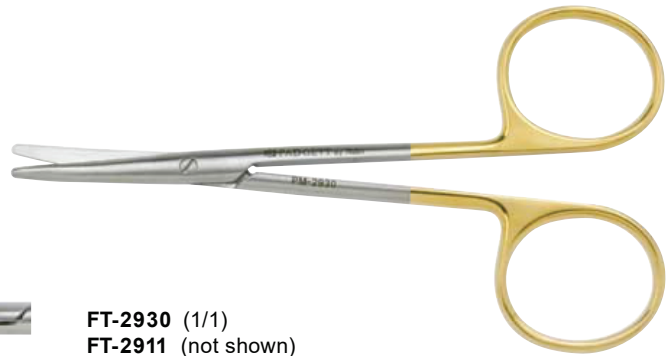

PAR Tissue & Dissecting Scissors, SuperCut & Tungsten Carbide

delicate blades with blunt tips, one micro fine serrated blade
4-1/2" (11.4 cm), curved
5-1/2" (14.0 cm), curved



FT-6855tc (1/1)
FT-6856tc (not shown)

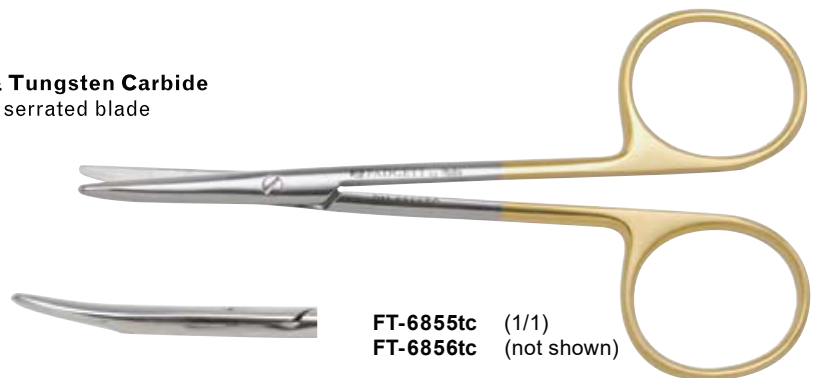

GREENBERG PAR Tissue & Dissecting Scissors, Tungsten Carbide

delicate blades with blunt tips, one serrated blade
4-1/2" (11.4 cm), curved



FT-2908 (1/1)

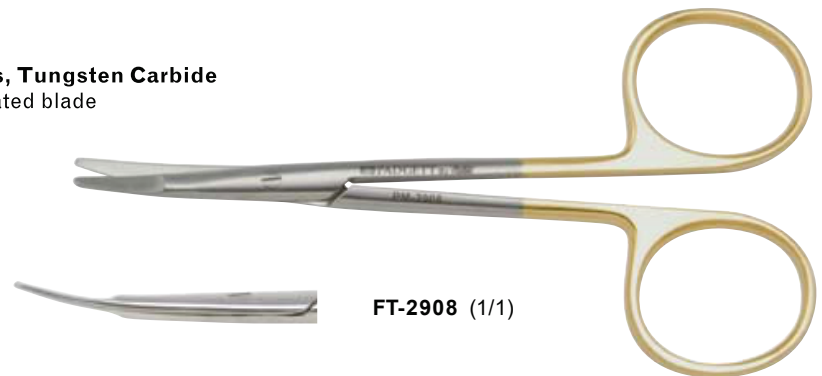

KAYE Blepharoplasty/Dissecting Scissors, Tungsten Carbide

one serrated blade
4-1/2" (11.4 cm), curved
4-1/2" (11.4 cm), curved



FT-5-269tc (1/1)
FT-29065 (not shown)

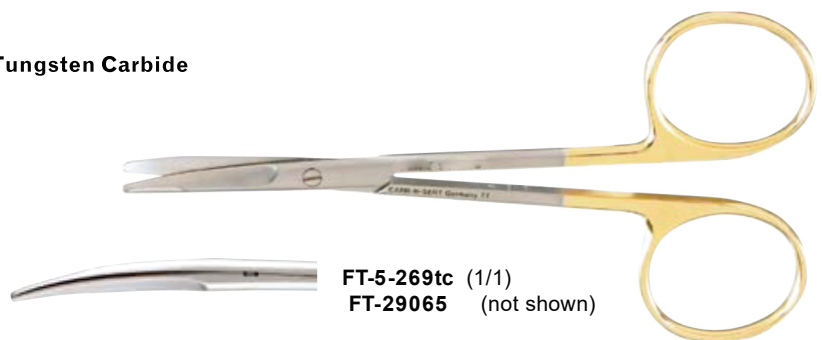

SCISSORS



JABALEY Scissors, SuperCut
semi-sharp tips, angled open shanks,
one micro fine serrated blade
4-1/2" (11.4 cm), straight
4-1/2" (11.4 cm), curved



Nawrooz® & Padgett Blepharoplasty/Dissecting Scissors, Tungsten Carbide
delicate flat tips, one serrated blade
4-1/2" (11.4 cm), curved
4-1/2" (11.4 cm), curved

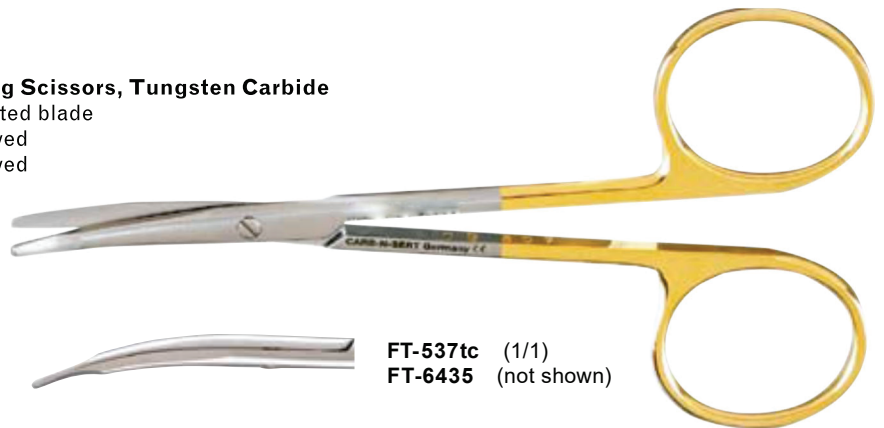

KAYE Blepharoplasty & Fine Dissecting Scissors
ribbon type, one serrated blade
4-1/4" (10.8 cm), curved
4-1/4" (10.8 cm), curved

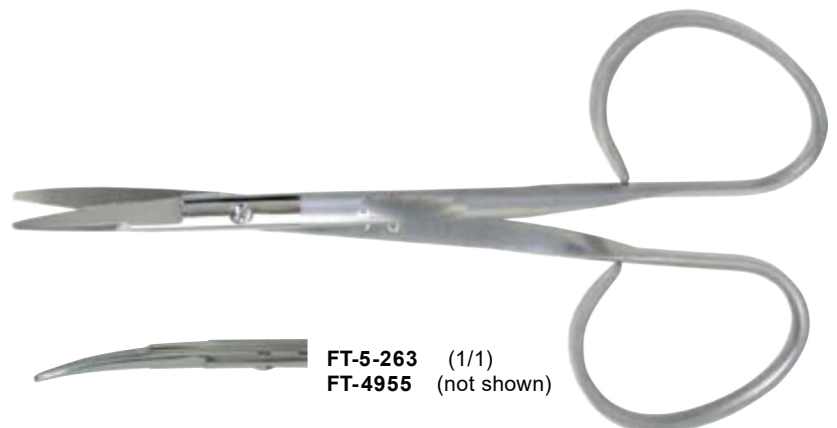

NEEDLE HOLDERS



NEEDLEHOLDERS



BARRAQUER Needle Holder

delicate smooth jaws

5-1/2" (14 cm), straight, with lock

5-1/2" (14 cm), curved, with lock

5-1/2" (14 cm), straight, without lock

5-1/2" (14 cm), curved, without lock



FT-18-1853 (1/1)

FT-18-1854 (not shown)



FT-18-1852 (1/1)

FT-18-1850 (not shown)

BARRAQUER Needle Holder

curved, standard smooth jaws

5-1/2" (14 cm), with lock

5-1/2" (14 cm), without lock



FT-18-1856 (1/1)

FT-18-1857 (not shown)

BARRAQUER Needle Holder

curved, smooth jaws,

10 mm wide hollow round handle

5" (12.7 cm), with lock

5" (12.7 cm), without lock



FT-18-1839 (1/1)

FT-18-1838 (not shown)

BARRAQUER Needle Holder

curved, smooth delicate tapered jaws,

8 mm wide solid round handle

5-1/8" (13 cm), without lock



FT-18-1840 (1/1)

NEEDLEHOLDERS



DREWS Needle Holder

extra delicate smooth jaws
4" (10.2 cm), straight, without lock
4" (10.2 cm), curved, without lock

4" (10.2 cm), straight, with lock
4" (10.2 cm), curved, with lock



FT-18-1860 (1/1)
FT-18-1862 (not shown)



FT-18-1863 (1/1)
FT-18-1861 (not shown)

McPHERSON Needle Holder

very delicate smooth jaws, without lock
4-1/2" (11.4 cm), straight
4-1/2" (11.4 cm), curved

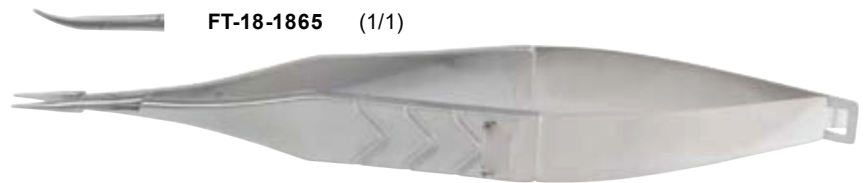

FT-18-1865 (1/1)

FT-18-1864 (1/1)

McPHERSON Needle Holder

very delicate smooth jaws, with lock
4-1/2" (11.4 cm), straight
4-1/2" (11.4 cm), curved



FT-18-1866 (1/1)
FT-18-1867 (not shown)

McPHERSON Needle Holder for Microsurgery

smooth tapered jaws, with lock
4" (10.2 cm), curved



FT-18-1837 (1/1)

NEEDLEHOLDERS



Aphrodite® Micro Surgery Needle Holders

curved, smooth jaws with 0.6 mm tips,
hollow round handles
5-1/4" (13.3 cm), without lock
5-1/4" (13.3 cm), with lock



CASTROVIEJO Needle Holder

smooth jaws, without lock
5-1/2" (14 cm), straight
5-1/2" (14 cm), curved



CASTROVIEJO Needle Holder

smooth jaws, with lock
5-1/2" (14 cm), straight
5-1/2" (14 cm), curved



CASTROVIEJO Needle Holder, Tungsten Carbide

straight, with lock
5-1/2" (14 cm), smooth jaws
5-1/2" (14 cm), smooth jaws

5-1/2" (14 cm), serrated jaws
5-1/2" (14 cm), serrated jaws

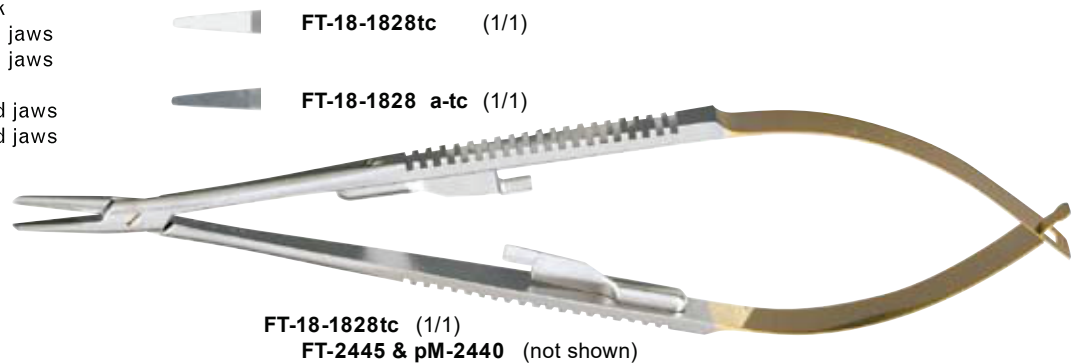

NEEDLEHOLDERS

CASTROVIEJO Needle Holder, Tungsten Carbide

curved, with lock
5-1/2" (14 cm), smooth jaws
5-1/2" (14 cm), smooth jaws
5-1/2" (14 cm), serrated jaws
5-1/2" (14 cm), serrated jaws



FT-18-1832tc (1/1)

FT-18-1832a-tc (1/1)

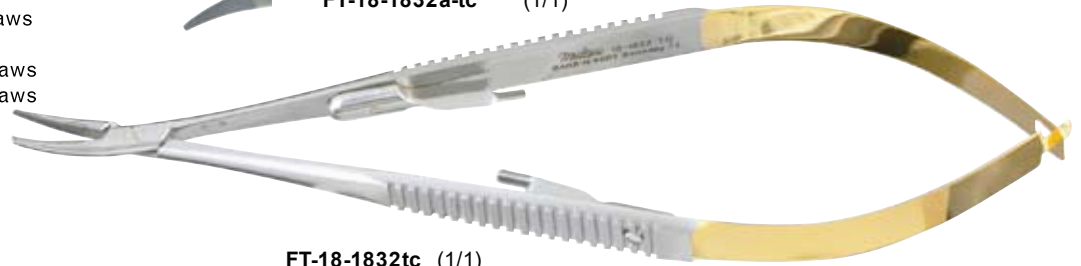

FT-18-1832tc (1/1)
FT-2446 & FT-2441 (not shown)

CASTROVIEJO Needle Holder

extra delicate smooth jaws, with lock
5-1/2" (14 cm), straight
5-1/2" (14 cm), curved



(1/1)

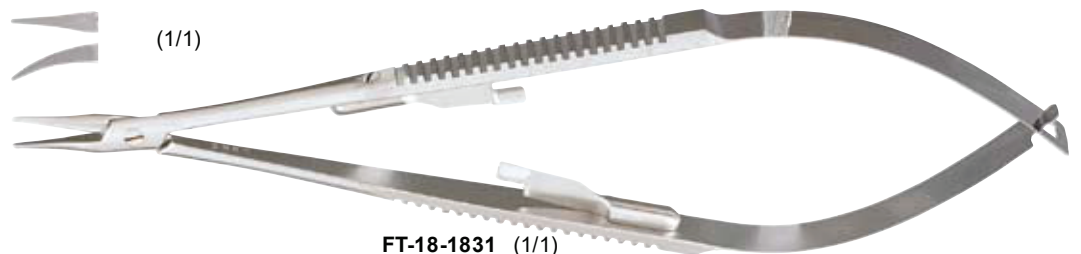

FT-18-1831 (1/1)
FT-18-1833

Nawrooz CASTROVIEJO Needle Holder, Tungsten Carbide

delicate smooth jaws, round hollow handles, with lock
4-3/4 (12.1 cm), straight



FT-18-1816tc (1/1)

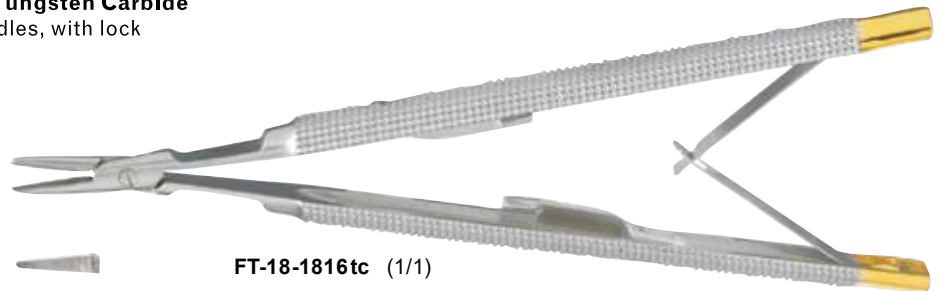

PADGETT-CASTROVIEJO Needle Holder

extra delicate smooth jaws, flat handles, with lock
holds 7/0 sutures
5-1/2" (14 cm), straight



FT-4709

NEEDLEHOLDERS



PATON Needle Holder
serrated jaws with notch, without lock
4-1/2 (11.4 cm), straight



KALT Needle Holder
delicate serrated jaws with notch,
standard model, with lock
5-1/4" (13.3 cm), straight

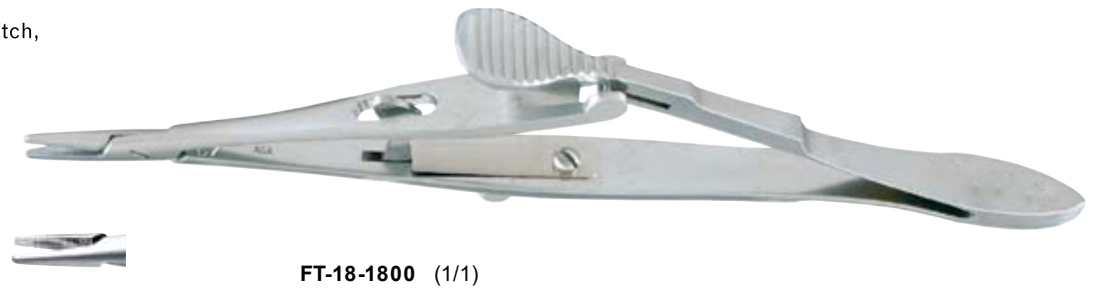

GREEN Needle Holder & Suturing Forceps
serrated jaws, double ended with serrations on
handle tips for gripping, without lock
4-1/4 (10.8 cm), angled



BOYNTON Needle Holder
delicate serrated jaws
5" (12.7 cm), straight

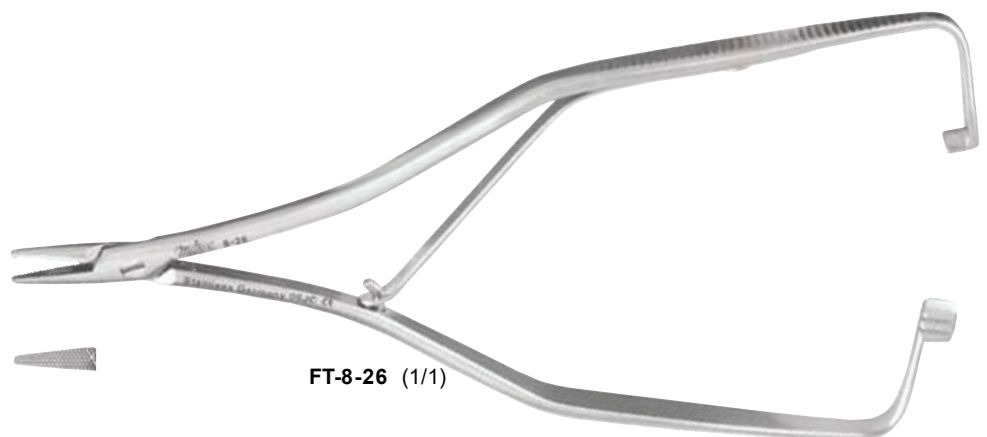

NEEDLEHOLDERS

PAR Needle Holder, Tungsten Carbide

delicate serrated jaws, straight

4-1/2 (11.4 cm)

4-3/4 (12.1 cm)

5" (12.7 cm)

5-1/4" (13.3 cm)



FT-8-3tc (1/1)

FT-8-5tc , FT-2404 & FT-2414 (not shown)

WEBSTER Needle Holder, Tungsten Carbide

delicate smooth jaws, straight

5-1/4 (13.3 cm)

4-3/4 (12.1 cm)



FT-8-6tc (1/1)

FT-2405 (not shown)

NEEDLEHOLDERS



WEBSTER Needle Holder, Tungsten Carbide

- extra delicate, straight
- 4-3/4" (12.1 cm), smooth jaws
- 4-3/4" (12.1 cm), serrated jaws

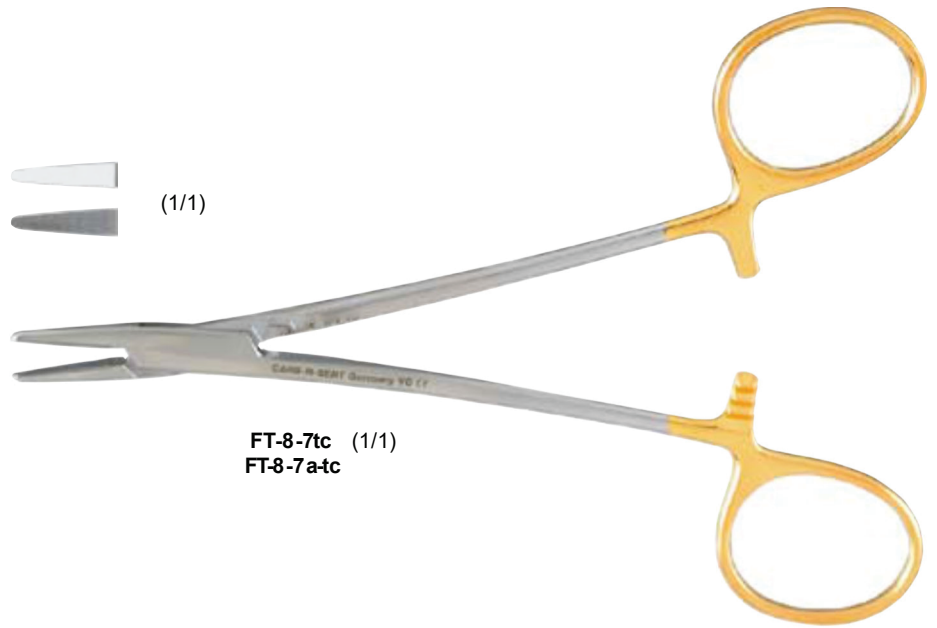

(1/1)

FT-8-7tc (1/1)
FT-8-7a-tc

OLSEN-HEGAR Needle Holder & Suture Scissors, Tungsten Carbide

- 4-3/4" (12.1 cm), serrated jaws
- 4-3/4" (12.1 cm), serrated jaws
- 4-3/4" (12.1 cm), smooth jaws
- 4-3/4" (12.1 cm), smooth jaws



FT-8-14 tc (1/1)
FT-2169

FT-8-14a-tc (1/1)
FT-2165

FT-8-14tc (1/1)

LACRIMAL INSTRUMENTS

DILATORS

ELEVATORS

PROBES

RONGEURS

CHISELS

NASAL SPECULA

MALLETS



LACRIMAL INSTRUMENTS



ZIEGLER Lacrimal Dilator

double ended
5-1/2" (14.0 cm)



FT-18-680

HOSFORD Lacrimal Dilator

double ended
4-3/4" (12.1 cm)



FT-18-688

CASTROVIEJO Lacrimal Dilator

double ended - needle point/medium tip
5-1/2" (14.0 cm)



FT-18-691

MULDOON Lacrimal Dilator

3 mm straight tip to act as guide for
tapered dilator
4" (10.2 cm)



FT-18-692

WILDER Lacrimal Dilator

4" (10.2 cm), size 1, fine taper
4" (10.2 cm), size 2, medium taper
4" (10.2 cm), size 3, heavy taper



FT-18-694



FT-18-696



FT-18-698

RUEDEMANN Infant Lacrimal Dilator

very delicate
3" (7.6 cm), 0.5 mm tip



FT-18-700



LACRIMAL INSTRUMENTS



FRENCH PATTERN Lacrimal Probe

- bayonet shape
- 5" (12.7 cm), size 00
- 5" (12.7 cm), size 0
- 5" (12.7 cm), size 1
- 5" (12.7 cm), size 2
- 5" (12.7 cm), size 3
- 5" (12.7 cm), size 4

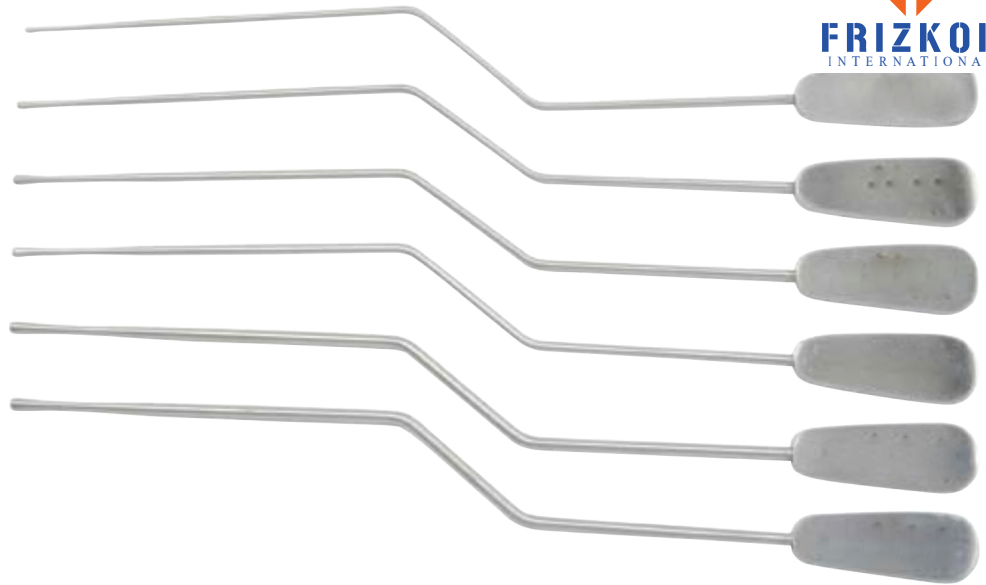

WILLIAMS Lacrimal Probe

- sterling, double ended
- 5" (12.7 cm), size 0000-000
- 5" (12.7 cm), size 00-0
- 5" (12.7 cm), size 1-2
- 5" (12.7 cm), size 3-4
- 5" (12.7 cm), size 5-6
- 5" (12.7 cm), size 7-8



BOWMAN Lacrimal Probe

- sterling, double ended
- 5" (12.7 cm), size 0000-000
- 5" (12.7 cm), size 00-0
- 5" (12.7 cm), size 1-2
- 5" (12.7 cm), size 3-4
- 5" (12.7 cm), size 5-6
- 5" (12.7 cm), size 7-8



WORST Pigtail Probe

for reconstruction of a torn tear duct
 6" (15.2 cm), with hook and spiral probe
 6" (15.2 cm), with hole and silicone cannula
 Spare Tubing for PM-4739HK & PM-4739HL



FT-4740



FT-4739hK
FT-4739hl (not shown)

Micro FRIEDMAN Rongeur

1.3 mm wide jaws, very delicate
 5-1/2" (14.0 cm), straight
 5-1/2" (14.0 cm), curved
 5-1/2" (14.0 cm), 90° angled

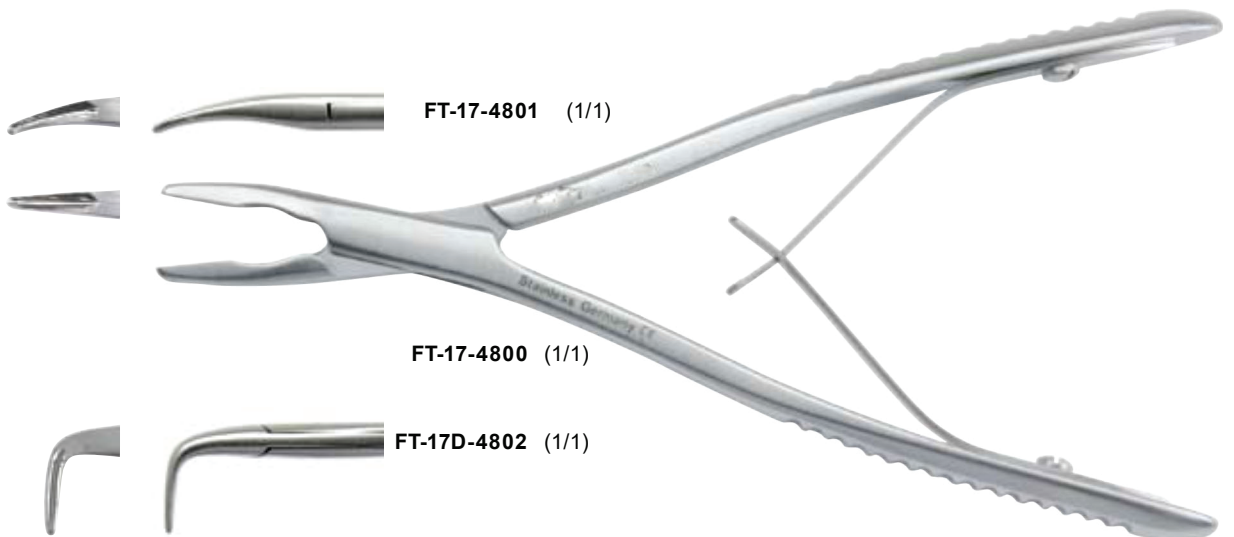

FT-17-4801 (1/1)

FT-17-4800 (1/1)

FT-17D-4802 (1/1)

LACRIMAL INSTRUMENTS

KERRISON Rongeur
3" (7.6 cm) shaft, size 0, 3.5 mm bite
3" (7.6 cm) shaft, size 1, 4.0 mm bite
3" (7.6 cm) shaft, size 2, 4.5 mm bite
3" (7.6 cm) shaft, size 3, 5.0 mm bite

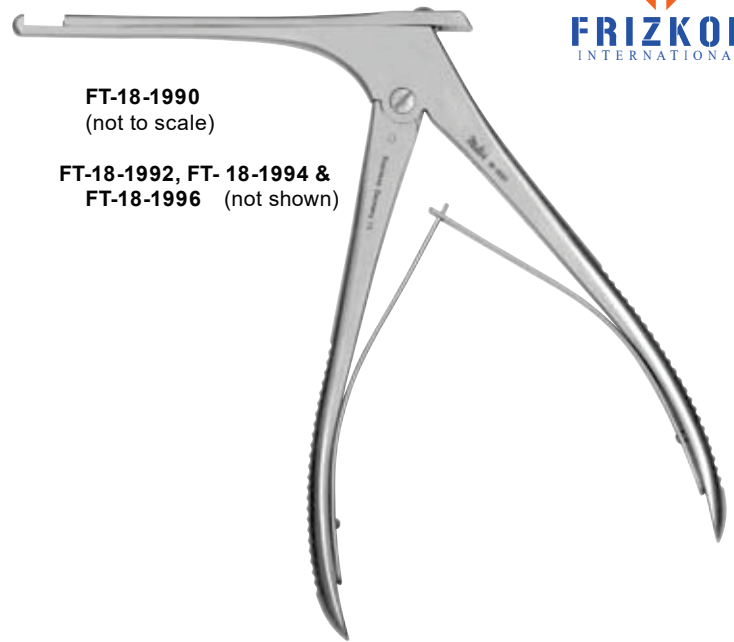

FT-18-1990
(not to scale)

**FT-18-1992, FT- 18-1994 &
FT-18-1996** (not shown)

BEYER Rongeur
3 mm bite, double action
7" (17.8 cm), slightly curved



FT-19-844 (not to scale)

LEMPERT Rongeur
2.5 mm bite, delicate
6-1/4" (15.9 cm), straight
6-1/4" (15.9 cm), curved

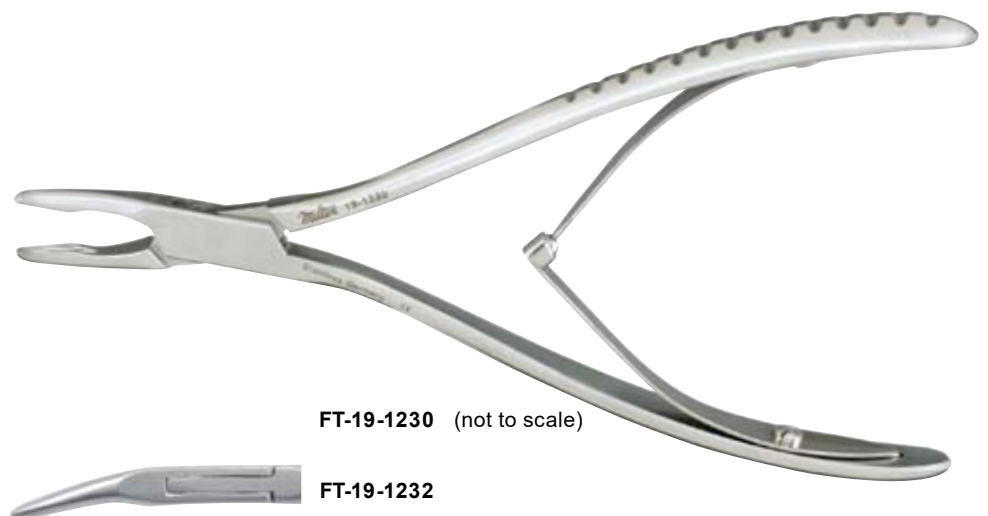

FT-19-1230 (not to scale)

FT-19-1232

LACRIMAL INSTRUMENTS



FREER Chisel

4 mm wide
6-1/2" (16.5 cm), curved



FT-18-1960

WEST Lacrimal Sac Chisel/Gouge

distal working end serrated for bone tamping and mallet interface control

6-1/4" (15.9 cm), straight, 5.0 mm wide, chisel
6-1/4" (15.9 cm), straight, 4.5 mm wide, gouge



FT-18-1962



FT-18-1964

FREER Elevator

double ended, sharp and blunt blades
7" (17.8 cm), curved, 5 mm wide

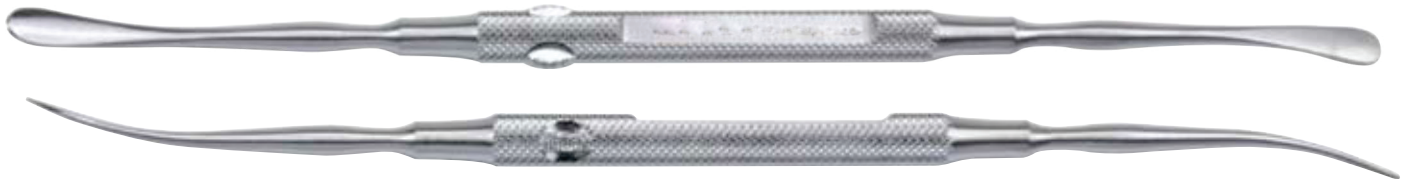

FT-18-1968

JOSEPH Periosteal Elevator

7" (17.8 cm), strong curve, 6.5 mm wide



FT-21-64

FOMON Periosteal Elevator

6-1/4" (15.9 cm), slightly curved, 4.5 mm wide



FT-21-68



LACRIMAL INSTRUMENTS



ARRUGA Lacrimal Trephine
 without center point, 7 mm diameter
 without center point, 8 mm diameter
 with center point, 8 mm diameter
 with center point, 9 mm diameter
 with center point, 10 mm diameter



FT-18-1950-7



FT-18-1950-7



FT-18-1950-8



FT-18-1952-8



FT-18-1952-9



FT-18-1952-10

TIECK (HALLE) Infant Nasal Speculum
 5-1/2" (14.0 cm)



FT-20-12
(1/1)

VIENNA Nasal Speculum
 lightweight
 5-3/4" (14.6 cm), child size
 5-3/4" (14.6 cm), adult size

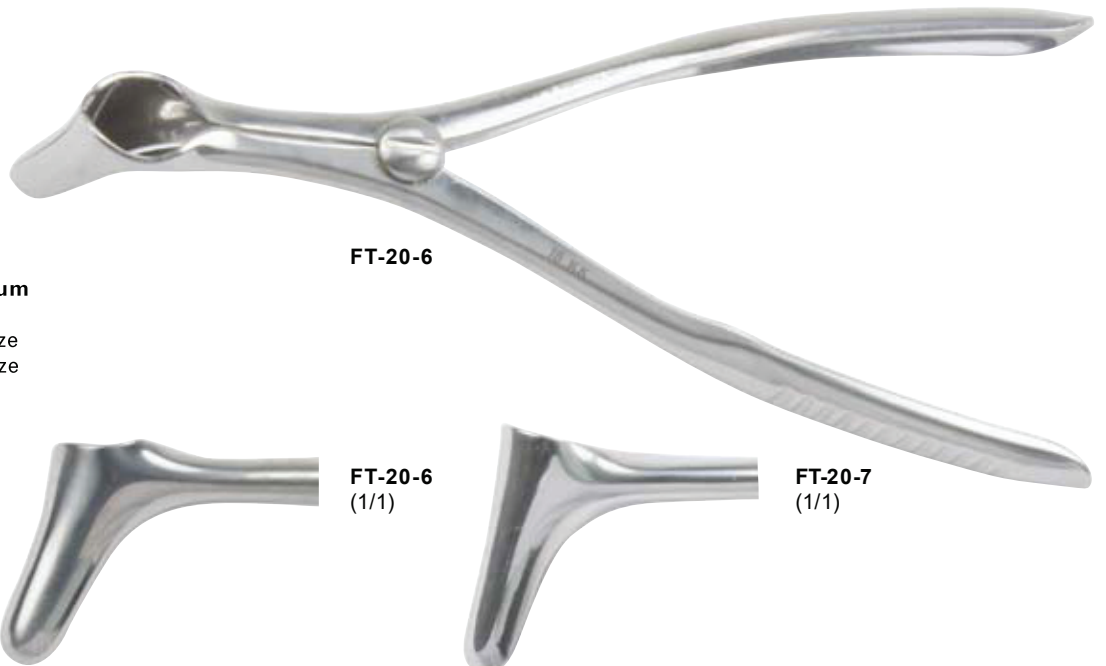

FT-20-6

FT-20-6
(1/1)

FT-20-7
(1/1)

LACRIMAL INSTRUMENTS



VIENNA Nasal Speculum
standard pattern
5-3/4" (14.6 cm), small size
5-3/4" (14.6 cm), medium size
5-3/4" (14.6 cm), large size

FT-20-4



FT-20-4 (1/1)



FT-20-3 (1/1)



FT-20-2 (1/1)

GERZOG Mallet

head 8 oz. (226 grams), lead filled with stainless jacket
7-1/2" (19.1 cm)



FT-19-790

Mallet

lightweight 7.5 oz. (213 grams), 1" (2.5 cm) diameter stainless
head with 2 replaceable nylon caps
7-1/2" (19.1 cm)

NYLON Cap Replacement
fits item 19-793



FT-19-795



FT-19-793 (not to scale)

CALIPERS



CALIPERS



SCHIOTZ Tonometer

includes 3 weights (5.5 gr., 7.5 gr. and 10 gr.), plunger, stainless steel footplate & test block original model same as no. 18-132, but with ALLEN Plunger Retractor*

All units are autoclavable and are constructed with jewelled hammers to minimize friction. Scale markings are etched for accuracy. Scales are inclined, permitting reading from above.

Each unit is supplied with certification so that it meets the specifications established by the Committee on Standardization of Tonometers of the A.A.O.O. Individually packaged in a fitted case with weights and test block.

*Allen Plunger Retractor - the plunger is held in a retracted position, flush with the surface of the footplate, until the tonometer is in place on the cornea. This feature helps to prevent possible damage to corneal tissue.



FT-18-132
FT-18-132a
(not shown to scale)

Case for SCHIOTZ Tonometers

fitted to firmly hold tonometer, weights and test block
6-1/2" (16.5 cm) x 3-1/2" (8.9 cm) x 1-1/4" (3.2 cm)



FT-18-139
(not shown to scale)

CASTROVIEJO Caliper

a combination measuring and marking caliper; graduated
3-1/4" (8.3 cm), straight, 0-20 mm
3-1/2" (8.9 cm), angled, 0-40 mm



18-650



FT-68-699

CALIPERS

THORPE Caliper
graduated in inches and millimeters;
permits measurements in deep areas
4-1/2" (11.4 cm)



FT-18-657

JAMESON Caliper
graduated in inches and millimeters with thin tips;
chrome
3-3/4" (9.5 cm)



FT-18-658

Flexible Stainless Ruler
graduated in 1/32" (0.8 mm) fractions and millimeters
6" (15.2 cm) x 1/2" (1.3 cm)
6" (15.2 cm) x 1/2" (1.3 cm), with pocket clip

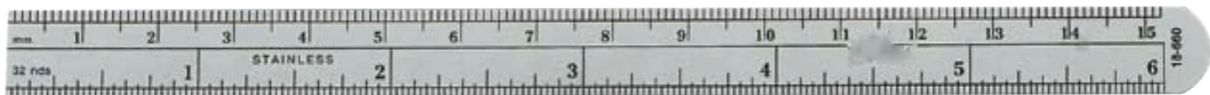

FT-18-660

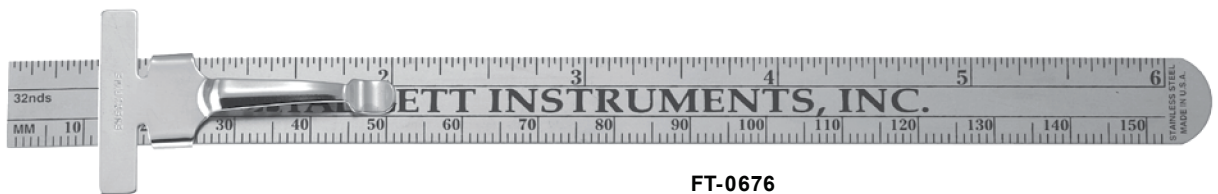

FT-0676

Micro Boley Gauge
stainless steel
5" (12.7 cm)

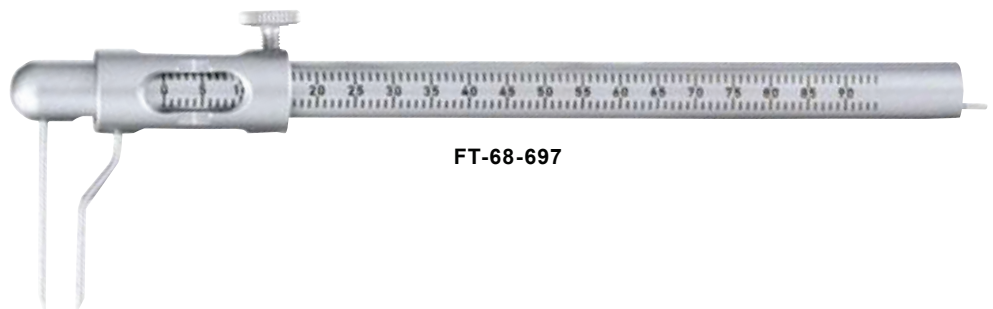

FT-68-697

BLADES, KNIFE HANDLES & ACCESSORIES



CALIPERS

Miniature Blade Handle
round knurled handle (3K type)
3-3/4" (9.5 cm), with chuck
3-3/4" (9.5 cm), with self-locking chuck



FT-4-400



FT-4-401

Self-Locking Chuck Knife Handle
round knurled handle (3K type)
5-1/4" (13.3 cm)

Note: Fits Mini Blade (blades not available from Miltex, Inc.)



FT-4-405

Knife Handle

No. 3, blades 10-15c, graduated
in mm/cm, flat handle
5" (12.7 cm)



FT-4-7

No. 9, blades 10-15c, stainless steel,
flat handle
4-1/2" (11.4 cm)



FT-4-16

SIEGEL Knife Handle

No. 3, blades 10-15c, round handle
5-3/4" (14.6 cm)



FT-4-17

BARRONS Knife Handle

No. 3, blades 10-15c, octagonal handle
5-1/2" (14.0 cm)



FT-4-25

KNIFE HANDLES



BARRAQUER Blade Breaker & Holder
with ratchet lock
4-1/2" (11.4 cm)

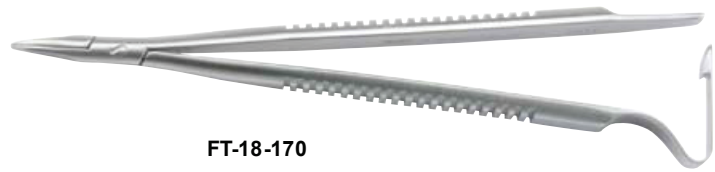

FT-18-170

CASTROVIEJO Blade Breaker & Holder
with push-pull lock
5-1/4" (13.3 cm)

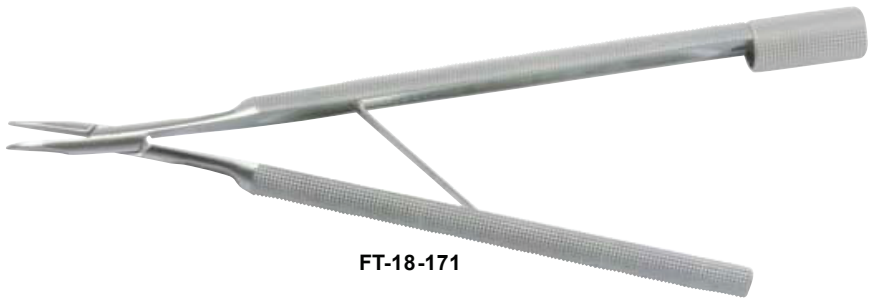

FT-18-171

TROUTMAN-BARRAQUER Mini Blade Breaker & Holder
angled jaws 3 x 10 mm, with push-pull lock
3-3/4" (9.5 cm)



FT-18-172

SURGICAL BLADES, Sterile
Carbon or Stainless Steel

- Razor-sharp cutting edges for superior cutting and clean incisions
- Sterile, 5-year shelf life
- Individually packaged in foil peel packs
- Convenience of disposables, single-use
- Sizes clearly marked on each blade
- Available in carbon and stainless steel
- Each dispenser box contains 100 blades
- Eleven sizes available

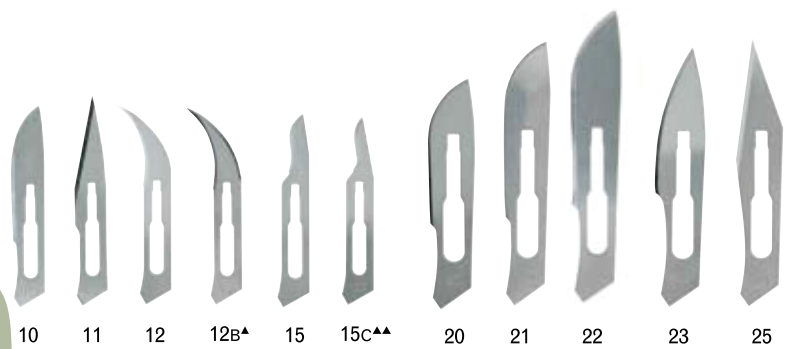

CS*	SS**	
REF	REF	
FT- 4-110	FT- 4-310	10
FT- 4-111	FT- 4-311	11
FT- 4-112	FT- 4-312	12
FT- 4-112B [▲]	FT- 4-312B [▲]	12B [▲]
FT- 4-115	FT- 4-315	15
FT- 4-115C ^{▲▲}	FT- 4-315C ^{▲▲}	15C ^{▲▲}

*Carbon Steel ** Stainless Steel
[▲] B is a double edged blade
^{▲▲} C is an angled blade

CS*	SS**	
REF	REF	
FT- 4-120	FT- 4-320	20
FT- 4-121	FT- 4-321	21
FT- 4-122	FT- 4-322	22
FT- 4-123	FT- 4-323	23
FT- 4-125	FT- 4-325	25

*Carbon Steel ** Stainless Steel
[▲] B is a double edged blade
^{▲▲} C is an angled blade

INSTRUMENT CARE & CLEANING



Frizkon® International Care & Cleaning Products

The Frizkon® care and cleaning product portfolio is designed to provide optimum cleaning performance and will help to prolong the service life of valuable surgical instrumentation.

Frizkon® International Prep Enzyme Foam

Ready-to-use foaming spray for pre-cleaning of soiled instruments and scopes (rigid or flexible). Ideal for applications where instrument cleaning is not immediately available. Simply spray on instruments until ready for decontamination and cleaning.

24 oz. (0.71 liter) spray bottles (case of 12)*



FT-3-760

Frizkon® Spray Lube (Surgical Instrument Lubricant)

pump bottle. Steam permeable and water soluble. Helps prevent spotting, staining and rusting. Lubricates instrument box locks, screw locks, scissors blades and any other metal on metal moving parts.

8 fl. oz. (0.24 liter) bottles (case of 12)*



FT-3-700

Frizkon® EZ-ZYME® All Purpose Enzyme Cleaner

Ideal for cleaning hard to remove proteinaceous (mucus & tissue) and lipid (fatty) materials from the surfaces of surgical and dental instruments, linen, water submersible equipment, or where mechanical scrubbing is impractical.

- Easy to Use
- Neutral pH
- Multi-use as an instrument presoak, ultrasonic cleaner, laundry presoak and evacuation system cleaner
- Space-saving or bulk packaging options

3/4 oz. (22 ml) packets (dispenser box of 32)

Contents of 1-box makes 32 gallons of solution

1-gallon bottle (3.79 liter)

Contents of 1-gallon container makes 170 gallons of solution



FT-3-755

FT-3-750

® Surgical Instrument Cleaner

Super concentrate formula for manual and ultrasonic cleaning or soaking of surgical instruments, accessories and glassware.

- Neutral pH
- Biodegradable
- Rinses free, leaves no residue
- Phosphate-free
- Concentrated

8 fl. oz. (0.24 liter) bottles (case of 12)*

Contents of one 8 oz. bottle makes 32 gallons of solution

1-gallon bottle (3.79 liter)

Contents of 1-gallon container makes 512 gallons of solution

1/4 fl. oz. (7.4 ml) packets (dispenser box of 80)

Contents of 1-box makes 80 gallons of solution



FT-3-725

FT-3-720

FT-3-726

Frizkon® Surgical Instrument Cleaner & Lubricant

A dual-purpose instrument cleaner and lubricant. Chemically engineered for use as a presoak or for manual cleaning, washer/decontaminators, ultrasonic cleaners and cart washers.

- Cleaner & Brighter Instruments
- Removes Stains, Blood and Mineral Deposits
- Biodegradable
- Concentrate, Lower Cost Per Use

1 Gallon (128 fl. oz.) 3.79L (see label for concentration rates)



FT-3-710

Frizkon® Instrument Lubricant

A water emulsible soaking agent works to extend the life of surgical instruments. Concentrated non-silicone lubricant and rust inhibitor. Use daily to keep moving parts operating smoothly.

- Formulated to extend the working life of surgical instruments
- Helps Prevent Corrosion
- Formulated with gentle, non-aggressive ingredients
- Frees Up Box Locks - Lubricates moving parts of surgical instruments

1 Gallon (128 fl. oz.) 3.79L (see label for concentration rates)



FT-3-705

Frizkon® Surgical Instrument Stain Remover

Powder formula removes stains, tarnish and restores luster to surgical instruments, autoclaves, ultrasonic cleaners, stainless steel countertops, etc. Ideal for use on stainless steel, chrome, nickel, brass, copper and silver.

- Effective on instruments, autoclaves, ultrasonic cleaners or any stainless steel, tile or plated surface
- Will not harm instrument surfaces
- Easy, fast, convenient to use
- Economical - a little goes a long way

3 oz. (85 grams), (case of 12)*



FT-3-740

Frizkon® Instrument Care Kit System

A great way to try various MILTEX® products!

Spray Lube (3-700), Surgical Instrument Cleaner (3-720),
Surgical Instrument Stain Remover (3-740),
Instrument Care DVD (3-810),
Nylon Brush and Stainless Steel Brush



FT-3-800

Frizkon® Instrument Care Training DVD

25-minute Instructional DVD assists practitioners and staff to properly care for instruments and to keep them in top working condition. DVD offers step-by-step guidance on handling, cleaning, rinsing, inspecting, lubricating and sterilizing surgical instruments.



FT-3-810



FT-3-1000

Frizkon® Nylon & Stainless Steel Brushes

- Nylon bristles for effective cleaning of instrument box locks
- Stainless steel bristles for cleaning serrations
- Autoclavable
 - 7-1/4 (18.4 cm), Nylon Bristles (Set of 3)
 - 7-1/4 (18.4 cm), Stainless Steel Bristles (Set of 3)



FT-3-1001

SILITONE Color Bands

Silitone color bands are made from medical-grade silicone and can withstand temperatures up to 450° F. Silitone bands are expandable from 4 mm to 12 mm and are available in a variety of colors. 50 pieces per pack except kits.

REF	Description
VSTSA	Grey - 50 pieces
VSTSB	Blue - 50 pieces
VSTSD	Gold - 50 pieces
VSTSG	Green - 50 pieces
VSTSK	Black - 50 pieces
VSTSL	Light Blue - 50 pieces
VSTSN	Brown - 50 pieces
VSTSP	Pink - 50 pieces
VSTSR	Red - 50 pieces
VSTSU	Purple - 50 pieces
VSTSW	White - 50 pieces
VTSY	Yellow - 50 pieces
VST	Kit of 12 colors - 480 pieces (40 of each color)
VSTA	Kit of 12 colors - 120 pieces (10 of each color)



Will work with ring-handled instruments!



Vst

TAPE N TELL Adhesive Strips

The Tape N Tell adhesive strips are ideal for color coding instruments and procedural kits.

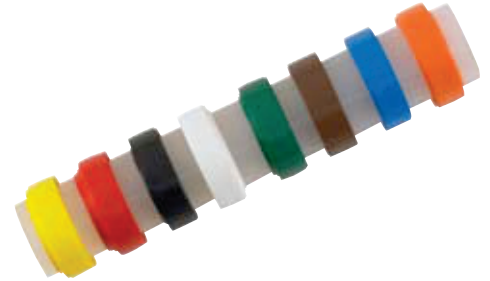

Ref	Description
FT-017-48220	TAPE NTELL WHITE
FT-017-48221	TAPE NTELL YELLOW
FT-017-48222	TAPE NTELL RED
FT-017-48223	TAPE NTELL BLUE
FT-017-48224	TAPE NTELL GREEN
FT-017-48225	TAPE NTELL BLACK
FT-017-48226	TAPE NTELL ORANGE
FT-017-48227	TAPE NTELL BROWN
FT-017-48230	TAPE NTELL 8 ASSORTED

TIP-IT Instrument Guards

Tip-It Instrument Guards protect instrument tips and edges from damage during handling and sterilization.

- PVC medical grade plastic
- Latex-free material
- Large holes (vented styles) to reduce vacuum and moisture build up for easy removal from instrument
- Steam and gas sterilizable
- 50 per pack

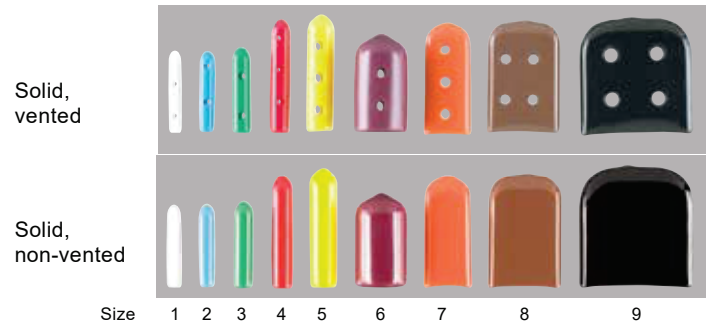
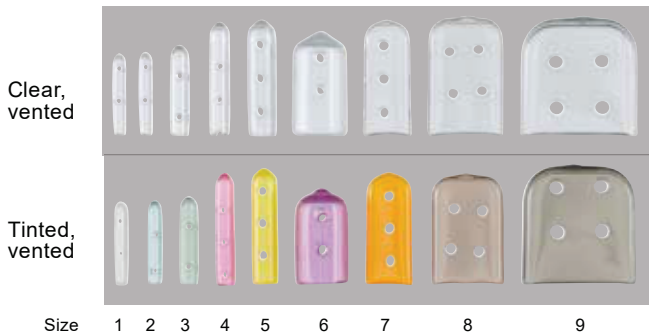

REF Clear Vented	REF Tinted Vented	REF Solid Vented	REF Solid Non-Vented	Dimension	Size Code	Color
FT- 3-2501C	FT- 3-2501T	FT- 3-2501V	FT- 3-2501	1/16 x 3/4 (1.6 mm x 19 mm)	1	White*
FT- 3-2502C	FT- 3-2502T	FT- 3-2502V	FT- 3-2502	5/64 x 3/4 (2 mm x 19 mm)	2	Blue*
FT- 3-2503C	FT- 3-2503T	FT- 3-2503V	FT- 3-2503	7/64 x 3/4 (2.8 mm x 19 mm)	3	Green*
FT- 3-2504C	FT- 3-2504T	FT- 3-2504V	FT- 3-2504	1/8 x 1 (3.2 mm x 25.4 mm)	4	Red*
FT- 3-2505C	FT- 3-2505T	FT- 3-2505V	FT- 3-2505	3/16 x 1 (4.8 mm x 25.4 mm)	5	Yellow*
FT- 3-2506C	FT- 3-2506T	FT- 3-2506V	FT- 3-2506	13/32 x 3/4 (10.3 mm x 19 mm)	6	Maroon*
FT- 3-2507C	FT- 3-2507T	FT- 3-2507V	FT- 3-2507	1/16 x 3/8 x 1 (1.6 mm x 9.5 mm x 25.4 mm)	7	Orange*
FT- 3-2508C	FT- 3-2508T	FT- 3-2508V	FT- 3-2508	5/64 x 5/8 x 1 (2 mm x 16 mm x 25.4 mm)	8	Brown*
FT- 3-2509C	FT- 3-2509T	FT- 3-2509V	FT- 3-2509	1/8 x 1 x 1 (3.2 mm x 25.4 mm x 25.4 mm)	9	Black*
FT- 3-2510C	FT- 3-2510T	FT- 3-2510V	FT- 3-2510	Assorted, equal number of sizes plus 5	-	-

* Color does not apply to clear vented pattern

Frizkon® Instrument Storage System featuring the Tuck-Away Lid

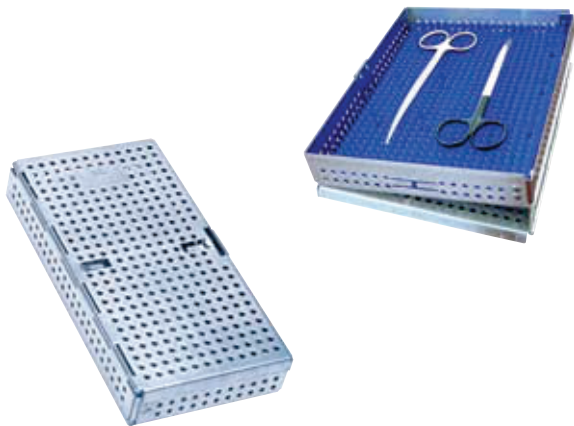

1. Unique flow-through design.
2. Medical grade silicone strip provides instrument retention when lid is closed.
3. Full length hinge provides stable and secure attachment to cassette.
4. Quick and easy push button release provides a positive lock when closed.
5. Pre-stamped tabs allow for custom coding of cassettes.
6. Double-hinged lid folds under cassette for easy storage during use.
7. Self-lubricating plastic hinge pin will not corrode and provides smooth mechanical movement.
8. Passivated stainless steel provides corrosion protection and an aesthetic finish.

Latex-Free Silicone Mats

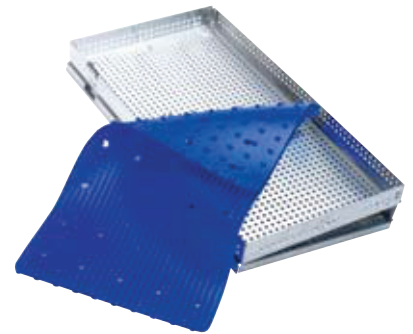

1. The raised mat (or feet) assures adhesion of the mat to the tray surface.
2. Holes positioned on mat for proper drainage.
3. Soft cushion fingers protect your instrument investment.
4. Customized to fit perfectly into Miltex® Cassettes.

UNIVERSAL CASSETTE WITHOUT MAT

REF	Size
FT- 4-6835	6-1/2 x 6-1/4 x 1-3/16
FT- 4-083000	8 x 3-13/16 x 1-3/16
FT- 4-084000	8 x 4-7/8 x 1-3/16
FT- 4-085000	8 x 6 x 1-3/16
FT- 4-089100	8 x 9 x 1-3/16
FT- 4-008122	8 x 11 x 1-3/16
FT- 4-008115	8 x 11 x 2
FT- 4-009126	9-1/8 x 13 x 1-3/16
FT- 4-6815	15 x 8-1/4 x 1-3/16

MAT ONLY

REF	Size	Description
FT- 4-6835MAT	6-1/2 x 6-1/4	for Cassette 4-6835
FT- 4-083000MAT	8 x 3-13/16	for Cassette 4-083000
FT- 4-084000MAT	8 x 4-7/8	for Cassette 4-084000
FT- 4-085000MAT	8 x 6	for Cassette 4-085000
FT- 4-089100MAT	8 x 9	for Cassette 4-089100
FT- 4-008122MAT	8 x 11	for Cassette 4-008122 & 4-008115
FT- 4-009126MAT	9-1/8 x 13	for Cassette 4-009126
FT- 4-6815MAT	15 x 8-1/4	for Cassette 4-6815

SLIMLINE SERIES WITHOUT MAT

FT- 3-072007	7 x 2-5/8 x 11/16*
FT- 3-082008	8 x 2-5/8 x 11/16*
FT- STDSL27	7 x 2-5/8 x 1*
FT- 3-072014	7 x 4-5/8 x 11/16*

*Single-hinge design

Tray with Silicone Mat

7 x 11 (17.8 x 27.9 cm), single layer

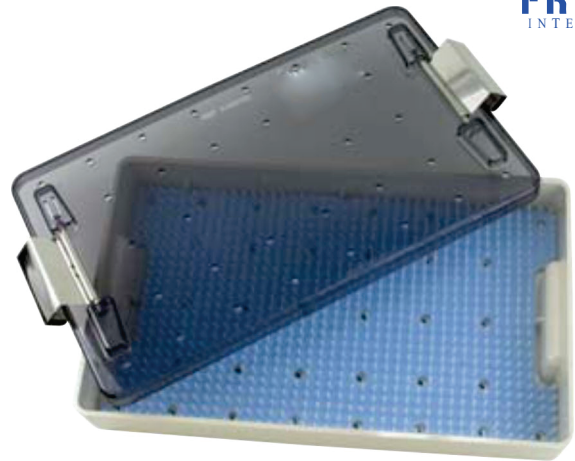

FT-3-200100
(not to scale)

Tray with Silicone Mats

7 x 11 (17.8 x 27.9 cm), double layer

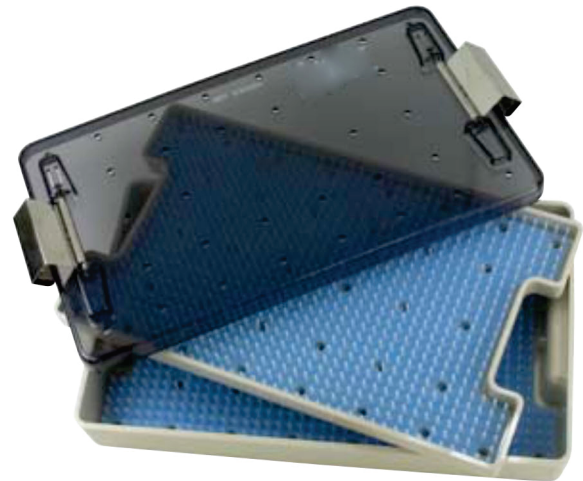

FT-3-200200
(not to scale)

Tray with Silicone Mat

4 x 8 (10.2 x 20.3 cm), single layer

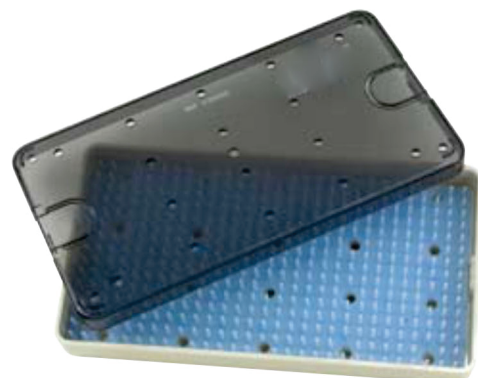

FT-3-200300
(not to scale)

Small Plastic Tray with Silicone Mat
2-3/4" x 1-3/4" x 3/4" (73 x 44 x 19 mm)



FT-9323
(not to scale)

Microsurgical Plastic Tray with Silicone Mat
10" x 5-3/4" x 3/4" (254 x 146 x 19 mm)

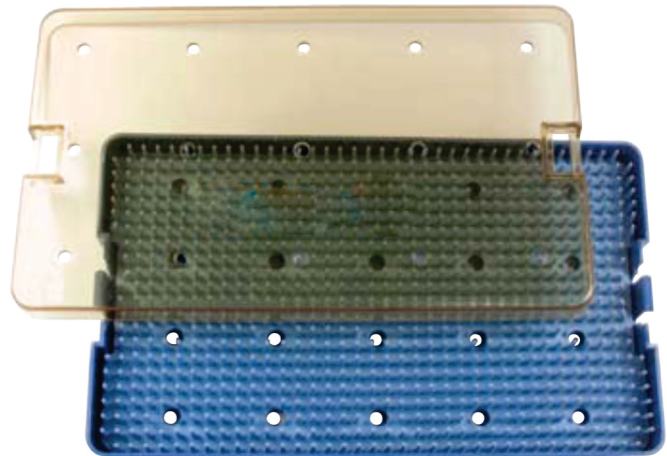

FT-9326
(not to scale)

Microsurgical Plastic Tray with Silicone Mat
11" x 7" x 3/4" (279 x 178 x 19 mm)

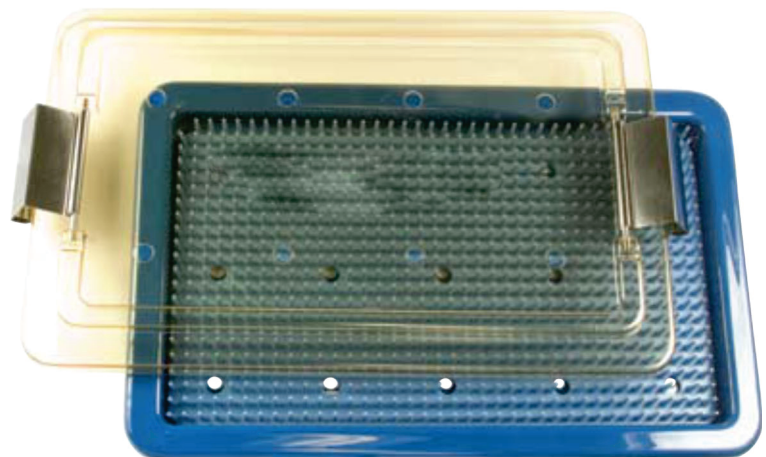

FT-9325
(not to scale)

SUGGESTED INSTRUMENT SET



COMBINED ECCE (Extra-Capsular Cataract Extraction) SET for PHACOEMULSIFICATION and/or MANUAL PHACOFRACTURE



REF	Key	Description
FT- 7-24	1	Hartman Mosquito Forceps, straight
FT- 7-501	2	Jones Towel Clamp
FT- 5-304	3	Iris Scissors, straight
FT- 4-401	4	Miniature Blade Handle, 3K type with locking chuck
FT- 18-1058	5	Schweiger Extra-Capsular Forceps, 4 x 5 teeth, curved
FT- 18-1070	6	Buratto IOL Insertion Forceps
FT- 18-1072	7	Dodick IOL Folding Forceps, for soft IOL
FT- 18-1073	8	Livernois IOL Folding Forceps, for soft IOL
FT- 18-1094	9	Inamura Capsulorhexis Forceps
FT- 18-123	10	Fine-Thornton Swivel Fixation Ring, blunt teeth, 13 mm
FT- 18-1489	11	Westcott Tenotomy Scissors, curved
FT- 18-1622	12	Vannas Scissors, very delicate sharp tips, curved
FT- 18-1640	13	Stern-Gills Scissors, angled
FT- 18-1863	14	Drews Needle Holder, curved, extra delicate, with lock
FT- 18-2162	15	Bishop-Harmon Irrigator, 19 gauge cannula with bulb
FT- 18-2003	16	Kansas Nucleus Bisector
FT- 18-2004	17	Alfonso Nucleus Trisector, 1.5 mm
FT- 18-2005	18	Bucher-Kansas Nucleus Trisector, 2.5 mm
FT- 18-2030	19	Alfonso Cutting Platform, 2 mm (<i>not illustrated</i>)
FT- 18-2031	20	Alfonso Cutting Platform, 3 mm (<i>not illustrated</i>)

REF	Key	Description
FT- 18-2008	21	Jaffe-Bechert Nucleus Rotator, blunt forked tip
FT- 18-2014	22	Rosen Phaco Splitter
FT- 18-2016	23	Dodick Nucleus Cracker, paddle shaped jaws
FT- 18-2026	24	Lester IOL Manipulator, angled
FT- 18-314	25	Von Graefe (Becker) Cystotome
FT- 18-468	26	Kuglen Iris Hook & Lens Manipulator, angled
FT- 18-39	27	Lieberman Eye Speculum, Kratz-style open wire blades
FT- 18-44	28	Temporal Approach Speculum, open wire blades
FT- 18-650	29	Castroviejo Caliper
FT- 18-880	30	Pierse Colibri Forceps, 1 x 1 teeth, 0.12 mm
FT- 18-923	31	Tennant Tying Forceps, straight
FT- 18-924	32	Tennant Tying Forceps, curved
FT- 18-931	33	Kelman-McPherson Forceps, smooth jaws, angled
FT- 18-953	34	Castroviejo Micro Suturing Forceps, 1 x 2 teeth, 0.12 mm
FT- 18-971	35	Bonnacollo Forceps, longitudinal & cross serrated tips, 1.2 mm
FT- PM-9421	36	Bipolar Jeweler Forceps, straight, 0.5 mm
FT- PM-9450D	37	Disposable Bipolar Cord, 12 feet, sterile, 10/box
FT- 18-2154	38	Air Injection Cannula, 27 gauge (<i>not illustrated</i>)
FT- 3-200200	39	Miltex® Double Tray with Silicone Mats (<i>not illustrated</i>)

ECCE (Extra-Capsular Cataract Extraction) using PHACOEMULSIFICATION



REF	Key	Description
FT- 7-24	1	Hartman Mosquito Forceps, straight
FT- 7-501	2	Jones Towel Clamp
FT- 4-401	3	Miniature Blade Handle, 3K type with locking chuck
FT- 18-1070	4	Buratto IOL Insertion Forceps
FT- 18-1073	5	Livernois IOL Folding Forceps, for soft IOL
FT- 18-1098	6	Kraff-Utrata Capsulorhexis Forceps, sharp tips
FT- 18-123	7	Fine-Thornton Swivel Fixation Ring, blunt teeth, 13 mm
FT- 18-1489	8	Westcott Tenotomy Scissors, curved
FT- 18-1622	9	Vannas Scissors, very delicate sharp tips, curved
FT- 18-1640	10	Stern-Gills Scissors, angled
FT- 18-1863	11	Drews Needle Holder, curved, extra delicate, with lock
FT- 18-2162	12	Bishop-Harmon Irrigator, 19 gauge cannula with bulb

REF	Key	Description
FT- 18-2008	13	Jaffe-Bechert Nucleus Rotator, blunt forked tip
FT- 18-2014	14	Rosen Phaco Splitter
FT- 18-2016	15	Dodick Nucleus Cracker, paddle shaped jaws
FT- 18-2026	16	Lester IOL Manipulator, angled
FT- 18-314	17	Von Graefe (Becker) Cystotome
FT- 18-468	18	Kuglen Iris Hook & Lens Manipulator, angled
FT- 18-39	19	Lieberman Eye Speculum, Kratz-style open wire blades
FT- 18-44	20	Temporal Approach Speculum, open wire blades
FT- 18-650	21	Castroviejo Caliper
FT- 18-880	22	Pierse Colibri Forceps, 1 x 1 teeth, 0.12 mm
FT- 18-923	23	Tennant Tying Forceps, straight
FT- 18-924	24	Tennant Tying Forceps, curved
FT- 18-931	25	Kelman-McPherson Forceps, smooth jaws, angled
FT- 18-953	26	Castroviejo Micro Suturing Forceps, 1 x 2 teeth, 0.12 mm
FT- PM-9425	27	Bipolar Jeweler Forceps, curved, 0.5 mm
FT- PM-9450D	28	Disposable Bipolar Cord, 12 feet, sterile, 10/box
FT- 18-2154	29	Air Injection Cannula, 27 gauge angled (<i>not illustrated</i>)
FT- 3-200200	30	Miltex® Double Tray with Silicone Mats (<i>not illustrated</i>)

MANUAL PHACOFRACTURE CATARACT EXTRACTION SET



REF	Key	Description
FT- 18-39	1	Lieberman Eye Speculum, Kratz-style open wire blades
FT- 5-304	2	Iris Scissors, straight
FT- 18-1489	3	Westcott Tenotomy Scissors, curved
FT- 18-953	4	Castroviejo Micro Suturing Forceps, 1 x 2 teeth, 0.12 mm
FT- 4-401	5	Miniature Blade Handle, 3K type with locking chuck
FT- 18-650	6	Castroviejo Caliper
FT- 18-1098	7	Kraff-Utrata Capsulorhexis Forceps, sharp tips
FT- 18-468	8	Kuglen Iris Hook & Lens Manipulator, angled
FT- 18-2003	9	Kansas Nucleus Bisector
FT- 18-2004	10	Alfonso Nucleus Trisector, 1.5 mm
FT- 18-2005	11	Bucher-Kansas Nucleus Trisector, 2.5 mm
FT- 18-2030	19	Alfonso Cutting Platform, 2 mm (<i>not illustrated</i>)
FT- 18-2031	20	Alfonso Cutting Platform, 3 mm (<i>not illustrated</i>)
FT- 18-2002	12	Kansas Nucleus Vectis, 3 mm
FT- PM-9421	13	Bipolar Jeweler Forceps, straight, 0.5 mm
FT- 18-1072	14	Dodick IOL Folding Forceps, for soft IOL
FT- 18-1070	15	Buratto IOL Insertion Forceps
FT- PM-9450D	16	Disposable Bipolar Cord, 12 feet, sterile, 10/box
FT- 18-2154	17	Air Injection Cannula, 27 gauge (<i>not illustrated</i>)
FT- 3-200200	18	Double Tray with Silicone Mats (<i>not illustrated</i>)

GLAUCOMA SURGERY SET



REF	Key	Description
FT- 7-501	1	Jones Towel Clamp
FT- 18-2162	2	Bishop-Harmon Irrigator, 19 gauge cannula with bulb
FT- 7-24	3	Hartman Mosquito Forceps, straight
FT- 18-66	4	Mellinger Eye Speculum, solid blades
FT- 18-35	5	Barraquer Wire Speculum, large
FT- 5-304	6	Iris Scissors, Straight
FT- 18-1489	7	Westcott Tenotomy Scissors, curved
FT- 18-1521	8	Barraquer Iris Scissors, angled
FT- 18-1635	9	Miltex-Vannas Scissors, curved
FT- 18-1485	10	McPherson-Westcott Stitch Scissors, curved
FT- 18-1112	11	Bennett Cilia Forceps (Qty 2)
FT- 18-880	12	Pierse Colibri Forceps, 1 x 1 teeth, 0.12 mm
FT- 18-868	13	Bishop-Harmon Forceps, 1 x 2 teeth, 0.7 mm
FT- 18-650	14	Castroviejo Caliper
FT- 4-401	15	Miniature Blade Handle, 3K type with locking chuck
FT- 18-1838	16	Barraquer Needle Holder, cturved, without lock
FT- 18-2154	17	Air Injection Cannula, 27 gauge angled (<i>not illustrated</i>)
FT- 3-200200	18	Nawrooz® Double Tray with Silicone Mats (<i>not illustrated</i>)

CORNEAL TRANSPLANT SURGERY SET

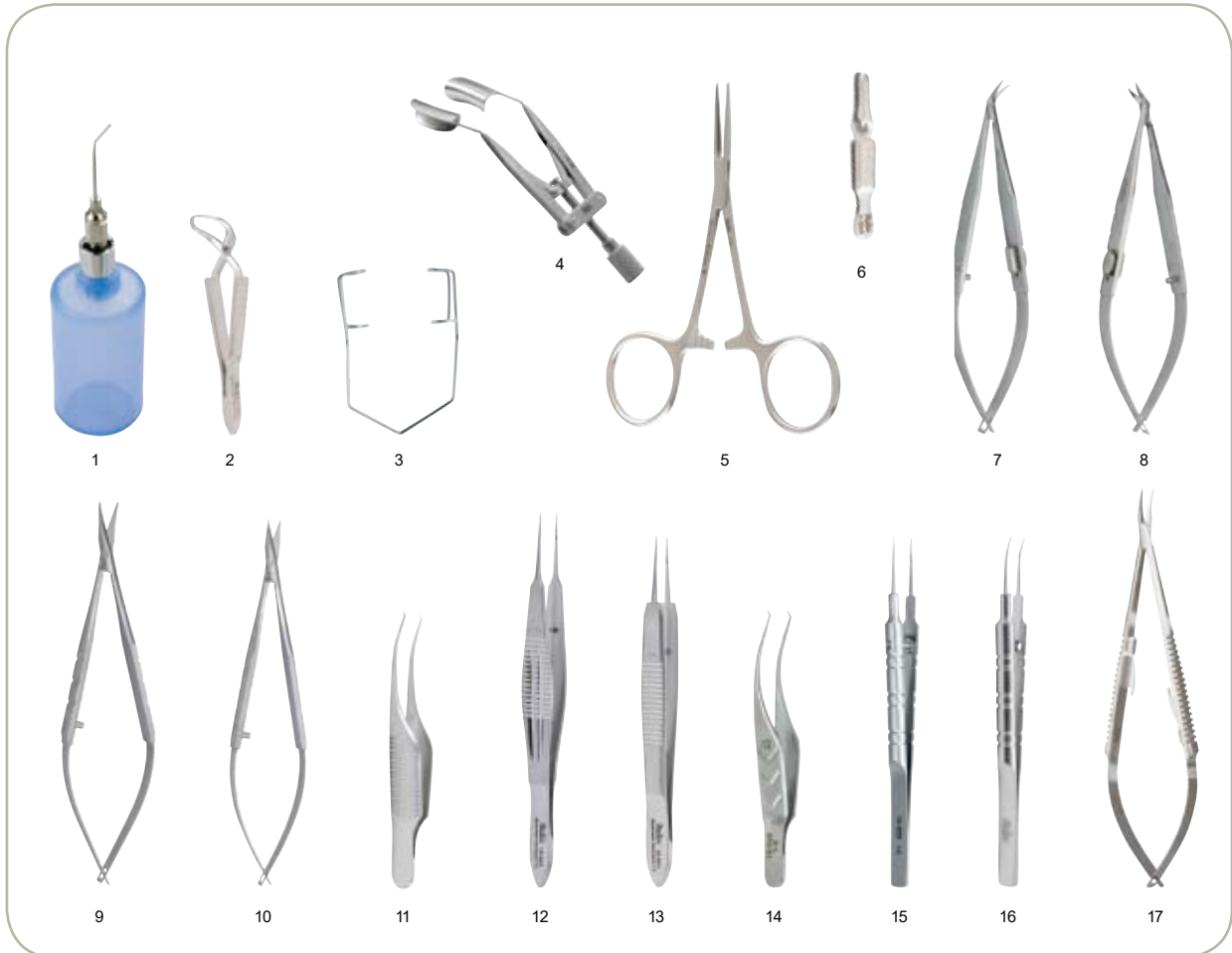

REF	Key	Description
FT- 18-2162	1	Bishop-Harmon Irrigator, 19 gauge cannula with bulb
FT- 7-501	2	Jones Towel Clamp
FT- 18-35	3	Barraquer Wire Speculum, large
FT- 18-38	4	Lieberman Eye Speculum, solid blade, large
FT- 7-24	5	Hartman Mosquito Forceps, straight (Qty 2)
FT- 7-304	6	Dieffenbach Serrefine, 1-1/2", straight (Qty 2)
FT- 18-1590	7	Troutman-Katzin Corneal Transplant Scissors, right
FT- 18-1589	8	Troutman-Katzin Corneal Transplant Scissors, left
FT- 18-1489	9	Westcott Tenotomy Scissors, curved
FT- 18-1335	10	Jaffe Stitch Scissors, curved
FT- 18-880	11	Pierse Colibri Forceps, 1 x 1 teeth, 0.12 mm
FT- 18-953	12	Castroviejo Micro Suturing Forceps, 1 x 2 teeth, 0.12 mm
FT- 18-951	13	Castroviejo Suturing Forceps, 1 x 2 teeth, 0.3 mm
FT- 18-928	14	Harms Colibri Forceps, 1 x 2 Teeth, 0.12 mm
FT- 18-923	15	Tennant Tying Forceps, straight
FT- 18-924	16	Tennant Tying Forceps, curved
FT- 18-1833	17	Castroviejo Needle Holder, curved, extra delicate, with lock
FT- 18-2152	18	Air Injection Cannula, 30 gauge (<i>not illustrated</i>)
FT- 3-200200	19	Nawrooz® Double Tray with Silicone Mats (<i>not illustrated</i>)

LASIK SURGERY SET

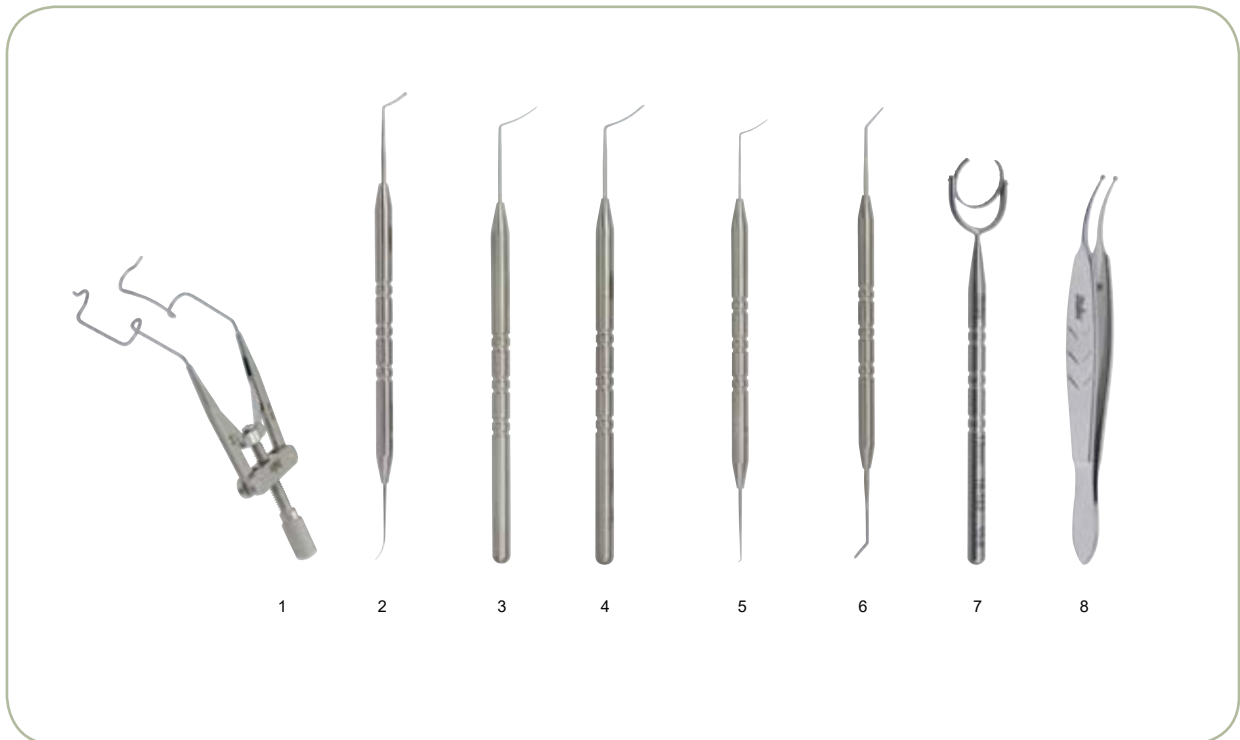

REF	Key	Description
FT- 18-39	1	Lieberman Eye Speculum, Kratz-style open wire blades
FT- 18-2028	2	Kritzinger-Updegraff LASIK Flap Elevator & Manipulator
FT- 18-593	3	Slade LASIK Retreatment Spatula, smooth
FT- 18-594	4	Slade LASIK Retreatment Spatula, serrated
FT- 18-597	5	Machat LASIK Retreatment Spatula
FT- 18-592	6	Herzig Elevator & Retreatment Spatula
FT- 18-123	7	Fine-Thornton Swivel Fixation Ring, blunt teeth, 13 mm
FT- 18-1091	8	Buratto LASIK Flap Forceps
FT- 3-200100	9	Nawrooz® Single Tray with Silicone Mat (<i>not illustrated</i>)

LID SURGERY SET



REF	Key	Description	REF	Key	Description
FT- 18-2162	1	Bishop-Harmon Irrigator, 19 gauge cannula with bulb	FT- 18-1824	13	Castroviejo Needle Holder, curved, without lock
FT- 7-8	2	Halsted Mosquito Forceps, straight	FT- 18-650	14	Castroviejo Caliper
FT- 7-10	3	Halsted Mosquito Forceps, curved (Qty 2)	FT- 18-112	15	Desmarres Lid Retractor, 14 mm
FT- 7-501	4	Jones Towel Clamp	FT- 18-114	16	Desmarres Lid Retractor, 16 mm
FT- 18-1472	5	Stevens Tenotomy Scissors, straight	FT- 18-116	17	Desmarres Lid Retractor, 18 mm
FT- 5-304	6	Iris Scissors, Straight	FT- 18-452	18	Von Graefe Strabismus Hook, medium
FT- 4-401	7	Miniature Blade Handle, 3K type with locking chuck	FT- 18-416	19	Guthrie Fixation Hook
FT- 18-1489	8	Westcott Tenotomy Scissors, curved	FT- 18-971	20	Bonnacolto Forceps, longitudinal & cross serrated tips, 1.2 mm
FT- 18-1486	9	Westcott Stitch Scissors, curved	FT- 18-868	21	Bishop-Harmon Forceps, 1 x 2 teeth, 0.7 mm
FT- 18-1138	10	Berke Ptosis Forceps, 27 mm	FT- 18-951	22	Castroviejo Suturing Forceps, 1 x 2 teeth, 0.3 mm
FT- 18-1838	11	Barraquer Needle Holder, curved, without lock	FT- 18-948	23	McPherson Suture Forceps, 0.3 x 5 mm, no teeth
FT- 18-120	12	Jaeger Lid Plate	FT- 18-1150	24	Erhardt Lid Forceps
			FT- PM-5012	25	Laser Eye Shield, set of 2 with suction handle
			FT- PM-9425	26	Bipolar Jeweler Forceps, curved, 0.5 mm
			FT- PM-9450D	27	Disposable Bipolar Cord, 12 feet, sterile, 10/box
			FT- 18-100	28	Knapp-Rollet Retractor, 4-sharp prongs
			FT- 3-200200	29	Nawrooz® Double Tray with Silicone Mat (not illustrated)

CHALAZION SURGERY SET



REF	Key	Description
FT- 18-120	1	Jaeger Lid Plate
FT- 18-500	2	Meyerhoefer Chalazion Curette, size 1
FT- 18-502	3	Meyerhoefer Chalazion Curette, size 2
FT- 18-504	4	Meyerhoefer Chalazion Curette, size 3
FT- 18-506	5	Meyerhoefer Chalazion Curette, size 4
FT- 5-304	6	Iris Scissors, straight
FT- 18-975	7	Manhattan Eye & Ear Suture Forceps
FT- 18-1178	8	Hunt Chalazion Forceps
FT- 18-1208	9	Francis Chalazion Forceps
FT- 18-1833	10	Castroviejo Needle Holder, curved, extra delicate, with lock
FT- 4-401	11	Miniature Blade Handle, 3K type with locking chuck
FT- 3-200100	12	Nawrooz® Single Tray with Silicone Mat (<i>not illustrated</i>)

STRABISMUS SURGERY SET



REF	Key	Description
FT- 18-37	1	Lieberman Eye Speculum, solid blade, small
FT- 18-38	2	Lieberman Eye Speculum, solid blade, large
FT- 7-26	3	Hartman Mosquito Forceps, curved (Qty 2)
FT- 7-304	4	Dieffenbach Serrefine, 1-1/2", straight (Qty 2)
FT- 18-450	5	Von Graefe Strabismus Hook, small
FT- 18-452	6	Von Graefe Strabismus Hook, medium
FT- 18-454	7	Von Graefe Strabismus Hook, large
FT- 18-440	8	Stevens Tenotomy Hook
FT- 18-442	9	Green Strabismus Hook
FT- 18-446	10	Jameson Strabismus Hook
FT- 18-564	11	Castroviejo Spatula
FT- 18-570	12	Green Spatula
FT- 18-568	13	Fisher Spoon & Needle

REF	Key	Description
FT- 18-650	14	Castroviejo Caliper
FT- 18-1489	15	Westcott Tenotomy Scissors, curved
FT- 18-1486	16	Westcott Stitch Scissors, curved
FT- 18-836	17	Bonn Suture Forceps, 1 x 2 teeth, 0.12 mm
FT- 18-628	18	Kirby Fixation Forceps, with lock
FT- 18-914	19	Lester Fixation Forceps, 2 x 3 teeth (Qty 3)
FT- 18-946	20	Harms Suture Forceps, smooth tying platform
FT- 18-1828	21	Castroviejo Needle Holder, straight, with lock
FT- 18-1853	22	Barraquer Needle Holder, curved, with lock
FT- 18-2162	23	Bishop-Harmon Irrigator, 19 gauge cannula with bulb
FT- 4-401	24	Miniature Blade Handle, 3K type with locking chuck
FT- 3-200200	25	Nawrooz® Double Tray with Silicone Mats (not illustrated)

LACRIMAL SURGERY SET

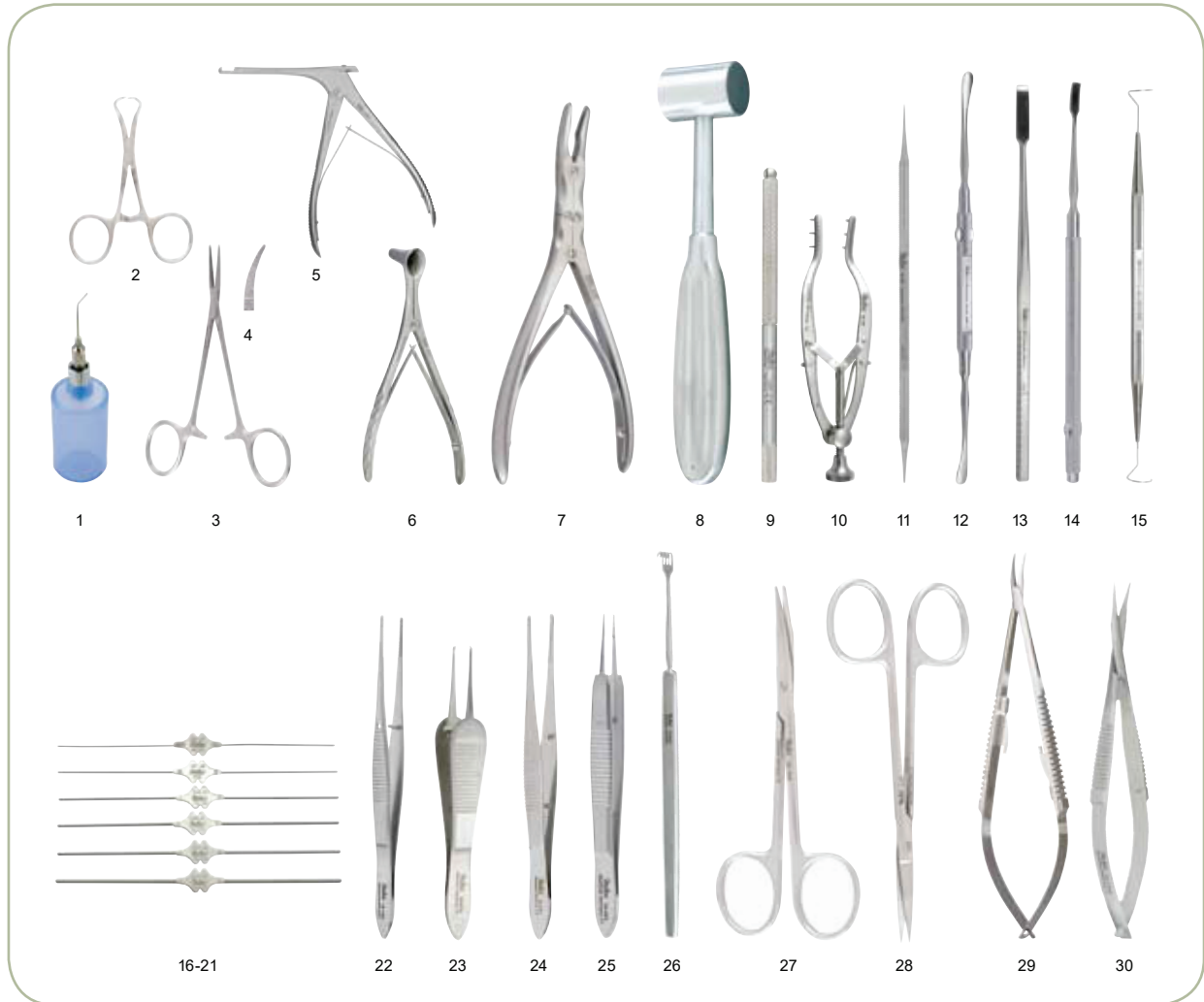

REF	Key	Description	REF	Key	Description
FT- 18-2162	1	Bishop-Harmon Irrigator, 19 gauge cannula w/bulb	FT- 18-740	16	Bowman Lacrimal Probe, size 0000-000
FT- 7-504	2	Backhaus Towel Clamp	FT- 18-742	17	Bowman Lacrimal Probe, size 00-0
FT- 7-8	3	Halsted Mosquito Forceps, straight (Qty 2)	FT- 18-744	18	Bowman Lacrimal Probe, size 1-2
FT- 7-10	4	Halsted Mosquito Forceps, curved (Qty 2)	FT- 18-746	19	Bowman Lacrimal Probe, size 3-4
FT- 18-1990	5	Kerrison Ronguer, size 0, 3.5 mm	FT- 18-748	20	Bowman Lacrimal Probe, size 5-6
FT- 20-2	6	Vienna Nasal Speculum, large	FT- 18-750	21	Bowman Lacrimal Probe, size 7-8
FT- 19-844	7	Beyer Ronguer, curved	FT- 18-780	22	Eye Dressing Forceps, straight, 0.8 mm
FT- 19-790	8	Gerzog Mallet, lead filled stainless	FT- 18-974	23	Sauer Fixation Forceps, 1 x 2 teeth
FT- 4-401	9	Miniature Blade Handle, 3K type with locking chuck	FT- 18-971	24	Bonnacolto Forceps, longitudinal & cross serrated tips, 1.2 mm
FT- 18-96	10	Stevenson Lacrimal Retractor	FT- 18-951	25	Castroviejo Suturing Forceps, 1 x 2 teeth, 0.3 mm
FT- 18-691	11	Castroviejo Lacrimal Dilator	FT- 18-102	26	Knapp Retractor, 4-blunt prongs
FT- 18-1968	12	Freer Periosteal Elevator	FT- 18-1476	27	Stevens Tenotomy Scissors, curved
FT- 18-1962	13	West Lacrimal Chisel, straight	FT- 5-304	28	Iris Scissors, straight
FT- 18-1960	14	Freer Lacrimal Chisel, curved	FT- 18-1833	29	Castroviejo Needle Holder, curved, extra delicate, w/ lock
FT- PM-4739HL	15	Worst Pigtail Probe with suture holes	FT- 18-1486	30	Westcott Stitch Scissors, curved
			FT- 3-200200	31	Nawrooz® Double Tray w/Silicone Mats (not illustrated)

VITREORETINAL SURGERY SET



REF	Key	Description
FT- 18-12	1	Castroviejo Eye Speculum, medium
FT- 7-304	2	Dieffenbach Serrefine, straight (Qty 4)
FT- 7-8	3	Halsted Mosquito Forceps, straight (Qty 2)
FT- 5-304	4	Iris Scissors, Straight
FT- 18-2162	5	Bishop-Harmon Irrigator, 19 gauge cannula with bulb
FT- 18-1472	6	Stevens Tenotomy Scissors, straight
FT- 18-1476	7	Stevens Tenotomy Scissors, curved
FT- 18-1489	8	Westcott Tenotomy Scissors, curved
FT- 18-1486	9	Westcott Stitch Scissors, curved
FT- 4-401	10	Miniature Blade Handle, 3K type with locking chuck
FT- 18-250	11	Schepens Orbital Retractor
FT- 18-452	12	Von Graefe Strabismus Hook, medium
FT- 18-2127	13	Retinal Detachment Hook (<i>not illustrated</i>)
FT- 18-2181	14	Schocket Scleral Depressor (<i>not illustrated</i>)

REF	Key	Description
FT- 18-650	15	Castroviejo Caliper
FT- 015999	16	Watzke Sleeve Spreading Forceps
FT- 18-971	17	Bonnaccolto Forceps, longitudinal & cross serrated tips, 1.2 mm
FT- 18-958	18	Nugent Utility Forceps, serrated
FT- 18-953	19	Castroviejo Micro Suturing Forceps, 1 x 2 teeth, 0.12 mm
FT- 18-951	20	Castroviejo Suturing Forceps, 1 x 2 teeth, 0.3 mm
FT- 18-868	21	Bishop-Harmon Forceps, 1 x 2 teeth, 0.7 mm (Qty 2)
FT- 18-1833	22	Castroviejo Needle Holder, curved, extra delicate, with lock
FT- 18-1831	23	Castroviejo Needle Holder, straight, extra delicate, with lock
FT- 18-922	24	McPherson Tying Forceps, straight
FT- 18-574	25	Castroviejo Cyclodialysis Spatula, 0.5 mm
FT- PM-9450D	26	Disposable Bipolar Cord, 12 feet, sterile, 10/box
FT- PM-9425	27	Bipolar Jeweler Forceps, curved, 0.5 mm
FT- 18-2153	28	Viscoelastic Aspirating Cannula, 22 gauge angled (<i>not illustrated</i>)
FT- 3-200200	29	Nawrooz® Double Tray with Silicone Mats (<i>not illustrated</i>)

ENUCLEATION SURGERY SET



REF	Key	Description
FT- 18-2	1	Lancaster Eye Speculum
FT- 18-550	2	Wells Enucleation Scoop
FT- 18-452	3	Von Graefe Strabismus Hook, medium
FT- 18-1472	4	Stevens Tenotomy Scissors, straight
FT- 18-1498	5	Enucleation Scissors, strong curve
FT- 18-786	6	Iris Tissue Forceps, straight, 0.8 mm
FT- 7-10	7	Halsted Mosquito Forceps, curved
FT- 3-200100	8	Nawrooz® Single Tray with Silicone Mats (<i>not illustrated</i>)

VETERINARY OPHTHALMIC SURGERY SET

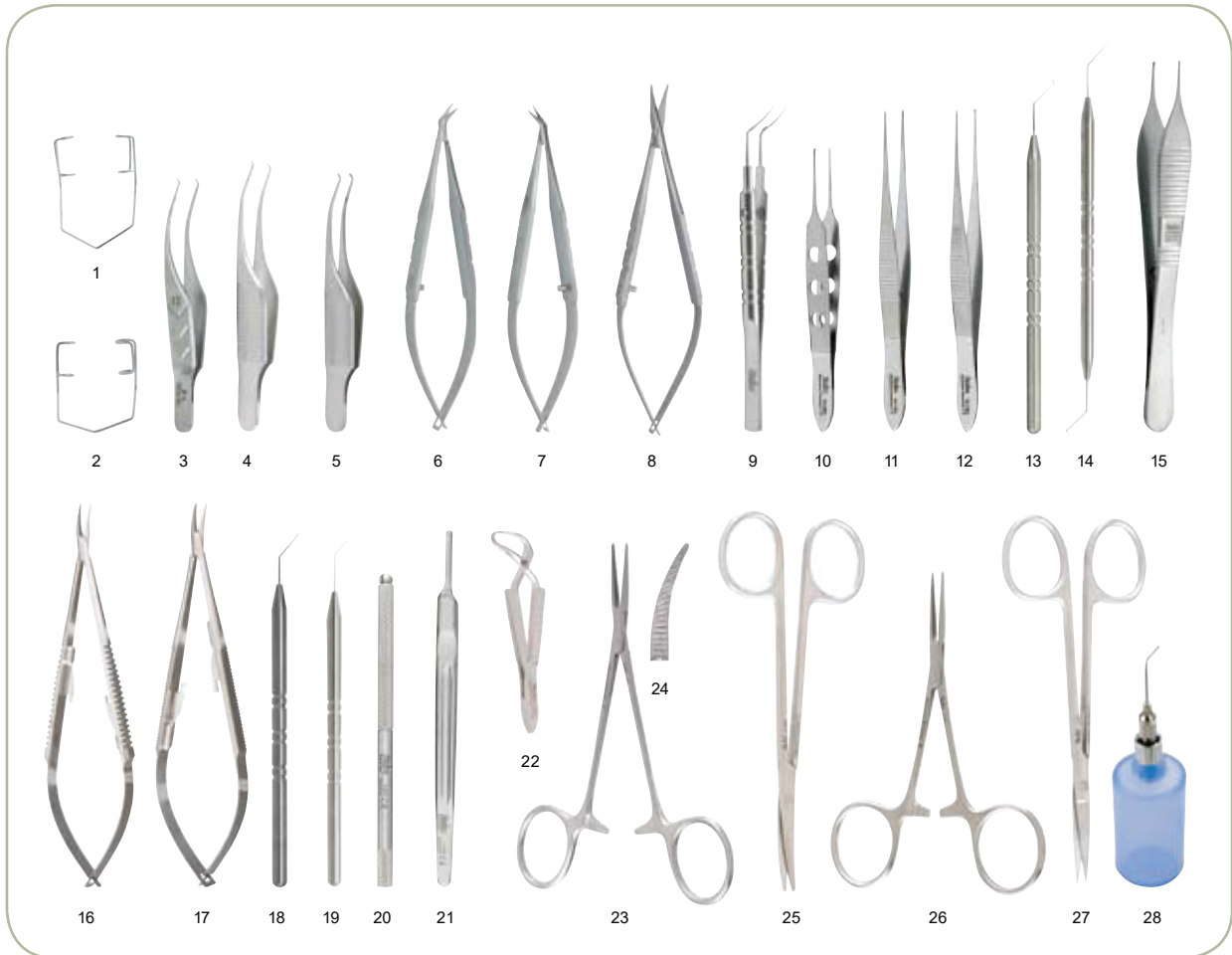

REF	Key	Description
FT- 18-35	1	Barraquer Wire Speculum, large
FT- 18-36	2	Barraquer Wire Speculum, small
FT- 18-928	3	Harms Colibri Forceps, 1 x 2 teeth, 0.12 mm
FT- 18-881	4	Pierse Colibri Forceps, 1 x 1 teeth, 0.3 mm
FT- 18-827	5	Troutman-Barraquer Colibri Forceps, 1 x 2 teeth, 0.4 mm
FT- 18-1579	6	Castroviejo Corneoscleral Scissors, right
FT- 18-1580	7	Castroviejo Corneoscleral Scissors, left
FT- 18-1489	8	Westcott Tenotomy Scissors, curved
FT- 18-1098	9	Kraff-Utrata Capsulorhexis Forceps, sharp tips
FT- 18-868	10	Bishop-Harmon Forceps, 1 x 2 teeth, 0.7 mm
FT- 18-779	11	Iris Dressing Forceps, straight, 0.5 mm
FT- 18-785	12	Iris Tissue Forceps, straight, 0.5 mm
FT- 18-2019	13	Nagahara Phaco Chopper
FT- 18-2017	14	Chang Duo Quick Chopper, left
FT- 17-2500	15	Micro Adson Tissue Forceps, 1 x 2 teeth, 0.5 mm

REF	Key	Description
FT- 18-1833	16	Castroviejo Needle Holder, curved, extra delicate, w/lock
FT- 18-1832	17	Castroviejo Needle Holder, curved, with lock
FT- 18-466	18	Sinsky II Lens Manipulating Hook, angled
FT- 18-2008	19	Jaffe-Bechert Nucleus Rotator, blunt forked tip
FT- 4-401	20	Miniature Blade Handle, 3K type with locking chuck
FT- 4-16	21	Knife Handle, No. 9
FT- 7-501	22	Jones Towel Clamp
FT- 7-8	23	Halsted Mosquito Forceps, straight (Qty 2)
FT- 7-10	24	Halsted Mosquito Forceps, curved
FT- 5-284	25	Metzenbaum Scissors, curved
FT- 7-24	26	Hartman Mosquito Forceps, straight
FT- 5-304	27	Iris Scissors, straight
FT- 18-2162	28	Bishop-Harmon Irrigator, 19 gauge cannula, with bulb
FT- 3-200200	19	Nawrooz® Double Tray with Silicone Mats (<i>not illustrated</i>)

CANNULAE & DEPRESSOR



CANULAE & DEPRESSOR



BISHOP-HARMON Irrigation Cannula, Luer Lock
19 gauge angled cannula

BISHOP-HARMON Irrigator
19 gauge angled cannula, adaptor and blue silicone bulb



FT-18-2164



FT-18-2162
(not to scale)

AIR INJECTION Cannula
30 gauge angled at 6 mm
27 gauge angled at 6 mm



FT-18-2152



FT-18-2154

VISCOELASTIC Aspirating Cannula, Luer Lock
22 gauge angled at 10 mm
19 gauge angled at 10 mm



FT-18-2155
FT-18-2153 (not shown)

GASS Retinal Detachment Hook
5-3/4" (14.6 cm), with oval hole



FT-18-2127

SCHOCKET Scleral Depressor
double ended, with pocket clip
5-1/4" (13.3 cm)



FT-18-2181

REFERENCE WARRANTY & REPAIR



Frizkon® SUPERCUT SCISSORS

SuperCut Scissors have a specially designed razor-sharp upper blade edge that cuts effortlessly through tissue. The lower blade has micro-fine serrations to hold tissue and prevent slippage. For easy identification, Frizkon® SuperCut Scissors have two black ring handles.

SuperCut scissors are designed to cut tissue only. Dropping or mishandling will cause the razor-sharp edge to nick or become irregular. Proper handling will ensure lifetime service. Resharpenering at regular intervals is recommended and is a service that Aphrodite provides.

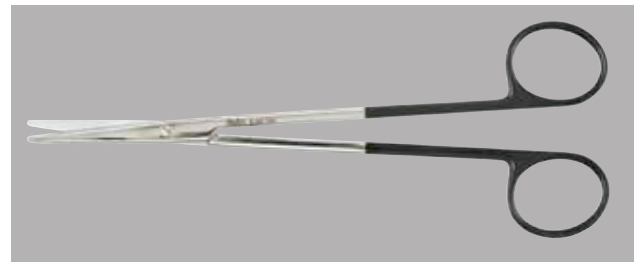
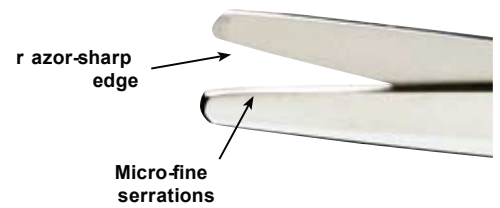

Frizkon® CARB-N-SERT® SCISSORS

Carb-N-Sert® Scissors have Tungsten Carbide inserts seamlessly bonded to the upper and lower blades. These premium-grade scissors offer precision cutting performance as well as the durability of Tungsten Carbide cutting edges.

Carb-N-Sert® Scissors represent a considerable cost savings to the clinician as a result of consistently superior performance and extended service life.

Frizkon® Carb-N-Sert® Scissors are easily identified by their gold ring handles.

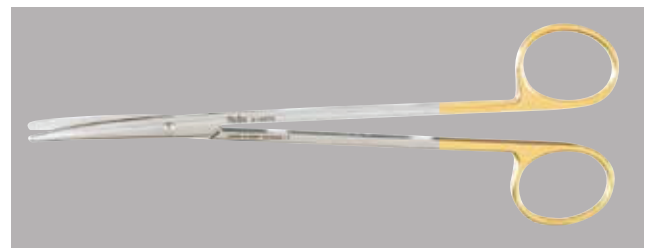
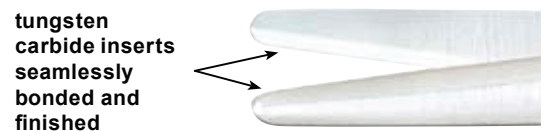

SUPERCUT/CARB-N-SERT® SCISSORS

The combination SuperCut/Carb-N-Sert® Scissors by Frizkon offer precision SuperCut performance with one lower serrated blade and one upper razor-sharp blade combined with the durability of Tungsten Carbide cutting edges.

SuperCut/Carb-N-Sert® Scissors are easily identified with one short and one long gold-plated ring handle.

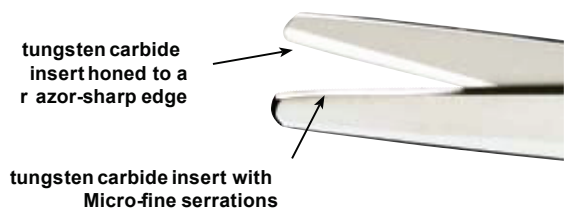

** Note: cold or chemical sterilization is not recommended for Tungsten Carbide instruments.*

AUTOCLAVING

Instruments are normally autoclaved with saturated steam at 134° Celsius, although a temperature of 121° Celsius may be used in conjunction with a longer exposure time on instruments with limited thermostability.

The sterilization procedure used on your instruments must be in compliance with sterilization standards and must be appropriate for the instruments to be sterilized. The packing materials used in the sterilization procedure must also be suitable for the procedure selected and must comply with all relevant quality sterilization standards.

STEAM AUTOCLAVE GUIDE

Temperature	121-134° C
Pressure	30 PSI
Cycle Time	Approximately 30 minutes; must maintain noted temperature & pressure level for 15 minutes
Sterilant	Steam
Sterilization Range	Stainless steel, glassware, Selected rigid materials

Be sure to refer to your autoclave manual or autoclave manufacturer for proper usage instructions.

Recommended Steps in Cleaning, Sterilization & Maintenance of Frizkon® Surgical Instruments

1. HOLDING/PRESOAK

Never hold instruments in a dry container. Doing so allows blood and debris to dry onto instrument surfaces and makes cleaning more difficult. If rinsing and decontamination processes are not immediately available, pre-treat instruments or hold them in a neutral pH holding/presoak enzymatic solution after patient use but before actual cleaning. Frizkon® Instrument Prep Enzyme Foam (3-760) is a ready to use foaming spray for pre-cleaning soiled instruments and scopes. Simply spray the foam on instruments until they are ready for processing. Also, Frizkon® EZ-Zyme® (3-750 and 3-755) neutral pH all purpose multi-enzyme concentrate is ideal for instrument presoaking and pre-cleaning. As soon as possible, rinse and clean as follows:

2. RINSING

(Always wear safety protection gear.) Immediately after surgery, remove organic materials by rinsing instruments under warm (not hot) running water. Rinse should remove most blood, fluids and tissue. Do not process dissimilar metals (stainless, copper, chrome plated, etc.) together.

Note: *Disinfection can be included to protect medical personnel from contamination during cleaning; however, protection also can be accomplished by following standard precautions by wearing appropriate PPE as promulgated by OSHA & AORN.*

3. CLEANING

All blood, dried body fluids and tissue should be completely removed from instruments prior to sterilization. Several methods for removing these materials are available.

A. Soak: An enzymatic cleaner bath (soak) such as Zomeda® EZ-Zyme® (3-750 and 3-755) or a solution of water and neutral pH (7) detergent such as Frizkon® Surgical Instrument Cleaner (3-720, 3-725 and 3-726) is effective in removing organic material from instruments. Use distilled (demineralized) water, if possible. Instruments should be fully submerged for at least 10 minutes. Do not let sharps (scissors, knives, osteotomes, etc.) touch each other. Ensure that dissimilar metal instruments are separated. Rinse instruments under running water to remove solutions and change solutions frequently.

B. Ultrasonic Cleaning: Most instrument manufacturers recommend ultrasonic cleaning as the most effective way to clean surgical instruments, particularly instruments with hinges, box locks and other moving parts.

- All instruments must be fully submerged in an open position using distilled (demineralized) water, if possible. To prevent possible surface scratching make sure that sharps do not touch other instruments. Also, separate instruments of dissimilar metals.
- Process instruments for the full recommended ultrasonic cleaning cycle. Change solution frequently or as often as the manufacturer recommends.
- Rinse instruments with water to remove the cleaning solution. Frizkon® EZ-Zyme® (3-750 and 3-755) or Frizkon® Surgical Instrument Cleaner (3-720, 3-725 and 3-726) can be safely used with all ultrasonic units.

C. Automatic Washer Sterilizers: Following manufacturers recommendations, ensure that instruments are lubricated before the sterilization cycle and after the last rinse cycle.

CAUTION: Needle holders and forceps may crack if sterilized with ratchet in closed position.

D. Manual Cleaning: If ultrasonic cleaning is not available, observe the following steps:

- Use stiff nylon cleaning brushes (3-1000). Do not use steel wool or wire brushes except stainless steel wire brushes (3-1001) specially recommended for instrument serrated areas, bone files, burs or on stained areas of knurled handles.

- Use only neutral pH (7) detergent such as Frizkon® Surgical Instrument Cleaner (3-720, 3-725 and 3-726). If not rinsed off properly, low pH (acidic - less than 6 pH) detergents break down the stainless protective surface resulting in pitting and/or black staining on instruments. High pH detergents (alkaline - more than 8 pH) can cause brown stains (phosphate surface deposit) which can also interfere with the smooth operation of instruments. Most brown stains are not rust and are easily removed with Frizkon® Surgical Instrument Stain Remover (3-740).

- Brush delicate instruments carefully, and if possible, separate them from general instruments.

- Make sure instrument surfaces are visibly clean and are free from stains and tissue. Frizkon® Surgical Instrument Stain Remover (3-740) can help remove residue stains. This is also a good time to inspect each instrument for proper function and condition.

- Check scissors' blades to ensure proper function. Blades should open and close smoothly. Test cutting performance at 3/4 length of the blade with the materials recommended below. Scissors should cut all the way to the tips. Recommended cutting test materials:

F ine/Delicate scissors: Surgical glove

Medium scissors: Single layer of stocking/cast netting

L arge/Utility scissors: Double layer of stocking/cast netting

- Check forceps (pickups) for proper jaw alignment. Teeth must meet properly without catching.
- Check hemostats and needle holders to ensure jaw tips close in first ratchet position and that the entire jaw closes in third ratchet position. Check instruments for loose hinges and verify that they lock and unlock easily. Also check instruments for wear on jaw surfaces.

- Suction tubes should be clean inside.

- Test Biopsy Punches by punching a clean hole in 3-6 mil thick poly-bag material. If poly-bag material is not available, use tissue paper.

- Retractors should function properly.

Recommended Steps in Cleaning, Sterilization & Maintenance of Frizkon® Surgical Instruments

- Cutting edge instruments and knives should be sharp and free of damage.
- After scrubbing, rinse instruments thoroughly under running water. While rinsing, open and close scissors, hemostats, needle holders and other hinged instruments to ensure that hinged areas are rinsed out and that no debris remains.

4. AFTER CLEANING

Separate dissimilar metals prior to sterilizing/autoclaving. If instruments will be stored, allow them to air-dry and store them in a clean and dry environment.

5. AUTOCLAVING

- A. **Lubricate all hinged instruments** which have any metal to metal action at the screw or box lock. A non-silicone, water-soluble surgical lubricant such as Frizkon® Lube (3-700 or 3-705) is recommended. Do not use industrial oils or lubricants.

- B. **Sterilize instruments** either individually or in sets.

- **Individual Instruments:** Disposable paper or plastic pouches are ideal. Make sure to use a wide enough pouch for instruments with ratchet locks so instruments can be sterilized in an open (unlocked) position. Instruments locked during autoclaving can develop cracked hinges (box locks) or other problems because of heat expansion. If wrapping instruments, make sure the towel does not contain detergent residue which can stain instruments.
- **Instrument Sets:** Unlock all instruments and sterilize in an open position. Place heavy instruments on the bottom of set (when two layers are required). Do not overload the chamber because an air pocket that hinders steam penetration may form.

CAUTION: With most portable tabletop autoclaves, unlock the door and open it no more than a crack, about 1/4 (6.4 mm). (at the end of the autoclave cycle and before the drying cycle) Then run the dry cycle for the period recommended by the autoclave manufacturer. If the autoclave door is fully opened before the drying cycle, cold air will rush into the chamber and will cause condensation on the instruments, potentially resulting in water stains or causing wet packs. Make sure autoclave filters and chambers are cleaned as recommended by the manufacturer. Frizkon® Surgical Instrument Stain Remover (3-740) is effective in removing stains and in cleaning the autoclave chamber. If you have any unusual staining on your instruments after sterilization, obtain our Instrument Care System DVD (3-810) or contact your local Frizkon® representative.

6. Chemical/cold sterilization

Most chemical/cold sterilization solutions render instruments sterile only after 10-hour immersion. This prolonged chemical action can be more detrimental to instruments than the usual 20-minute autoclave cycle. If the instruments need to be "disinfected" only, a chemical/cold sterilization soak is acceptable, as disinfection will take approximately 10 minutes or more. Check manufacturers' specifications. Also see our warning in using bleach (paragraph 3).

Keep in mind the difference between:

- Sterile - an absolute term (no living organism survives); and
- Disinfected - basically clean. Some organisms may survive. Always use the proper sterilization/cleaning technique to render the instrument in the required condition for use.

CAUTION: for instruments with tungsten carbide insert jaws, the use of chemical/cold sterilization solutions is not recommended as it may deteriorate the instrument's jaw.

We recommend these Frizkon products to properly safeguard and care for your quality instruments.

ref	Description	use During
3-760	instrument Prep enzyme foam 24 oz. spray	• Holding & presoak
3-750	eZ-Zyme®, All Purpose enzyme Cleaner box 32 - 3/4 oz. packets	• Holding & presoak • Soak cleaning • ultrasonic cleaning
3-755	eZ-Zyme®, All Purpose enzyme Cleaner 1-gallon pump bottle	• Manual cleaning • laundry presoak
3-700	Spray lube 8 oz. spray bottle	• before autoclaving
3-705	Surgical instrument lubricant 1-gallon pump bottle	
3-710	Surgical instrument Cleaner & lubricant 1-gallon pump bottle	• Manual cleaning • Washer/decontaminator • ultrasonic cleaning
3-720	Surgical instrument Cleaner 8 oz. spray bottle	• Soak cleaning • ultrasonic cleaning • Manual cleaning
3-725	Surgical instrument Cleaner 1-gallon pump bottle	
3-726	Surgical instrument Cleaner box 80 - 1/4 oz. packets	
3-740	Surgical instrument Stain Remover 3 oz. jar	• Stain removal
3-1000	nylon instrument Cleaning brushes 3-pack	• Manual cleaning of instruments
3-1001	Stainless Steel instrument Cleaning brushes 3-pack	
3-800	instrument Care System	• Complete instrument care
3-810	instrument Care DVD	• Training personnel in the care of instruments

A

AcrylicIOI implantationforceps45
 ADAMSO n Hook & Retractor12
 Adhesive Strips139
 ADSOn Dissecting forceps70
 ADSOn Dressing forceps57, 68-70
 ADSOn Dressing, Tissue & Suture forceps70
 ADSOn forceps57, 68-71, 74, 156
 ADSOn Tissueforceps57, 69-71
 ADSOn-bROWn Tissueforceps71
 ADSOn bipolar forceps74
 Aebli Corneal Scissors86
 AGRICOIAI acrimal Sac Retractor8
 Air injection Cannula144-148, 158
 AKAHOSH i Combo Prechopper44
 AKAHOSH i universal Prechopper44
 Alf OnSO Cutting Platform31, 144, 146
 Alf OnSO nucleus Trisector31, 144, 146
 Amin (CASTRO vieJO) fixationforceps65
 Ami S foreignbody Spud17
 AniS ball Tipnucleus Manipulator29
 Applying forceps for Micro Clips81
 ARRUGA Capsuleforceps43
 ARRUGAI acrimal Trephine127
 Aspirating Cannula154, 158
 AyeR Chalazionforceps63

b

bACKHA uS Towel Clamp79, 153
 bAiRD Chalazionforceps62
 ball end instruments10, 29, 32
 ball Tip Manipulator29, 32
 bARKAn Goniotomy Knife16
 bARRAQueR blade breaker & Holder134
 bARRAQueR Cilia & Sutureforceps61
 bARRAQueR iris Scissors96, 147
 bARRAQueR needle Holder114, 147, 150, 152
 bARRAQueR Speculum1, 147-148, 156
 bARRAQueR- TROuTMan Colibriforceps52
 bARROnS Knife Handle133
 bayonet bipolar forceps74
 bayonet forceps72, 74
 beAuPRE Cilia forceps61
 beChERT lens Holdingforceps47
 beChERT nucleus Rotator28
 beCKeR (vOn GRAefe) Cystotome16, 144-145
 beeR Cilia forceps60
 benne TT Cilia forceps61, 147
 beRGH Cilia forceps61
 beRKe Ptosisforceps62, 150
 beye R Rongeur125, 153
 bipolar forceps74, 144-146, 150, 154
 bipolar instrument Cable75, 144-146, 150, 154
 bisector30
 biSHOP-HARMO n Dressing forceps54
 biSHOP-HARMO n forceps54-55, 147, 150, 154, 156
 biSHOP-HARMO n iris Tissueforceps55
 biSHOP-HARMO n irrigator144-145, 147-148, 150, 152-154, 156, 158
 biSHOP-HARMO n Tissueforceps54
 blade breakers134
 blade Handles133, 156
 blades134
 bl AyDeS lens Holdingforceps47
 blepharoplastyforceps73
 blepharoplasty Scissors111-112
 boat Hook35
 boley Gauge131
 bOnn Micro Suturing forceps51, 152
 bOnn Miniature iris Scissors102
 bOnnACCOITO utilityforceps68, 144, 150, 153-154

bOTvin iris forceps53
 bOWMAN I acrimal Probe123, 153
 bOWMAN needle with Stop15
 bOynTOn needle Holder118
 bRACKen iris forceps56
 bROWn-ADSO n Tissueforceps71
 brushes138
 buChER-KAnSAS nucleus Trisector31, 144, 146
 bulldog Clamps79-80
 bun Ge evisceration Spoon41
 buRATTO ii Acrylic iOI implantationforceps45
 buRATTO IASiK flap forceps48, 149
 buRATTO Soft iOI insertingforceps46, 144-146

C

Cables75
 Calipers130-131
 Cannula144-148, 150, 152-154, 156-158
 Canthus Specula6
 Cap replacement32, 34-35, 128
 Capsule forceps43-44
 Capsulorhexisforceps43-44
 Capsulotomy Scissors83
 Carbon Surgicalblades134
 Care & Cleaning136-142
 Care & Cleaning Products136-142
 Case for SCHOTZ Tonometers130
 Cassettes140-142
 CASTROvieJO (Amin) fixationforceps65
 CASTROvieJO blade breaker & Holder134
 CASTROvieJO Caliper130, 144-147, 150, 152, 154
 CASTROvieJO Capsuleforceps44
 CASTROvieJO Colibri Corneal forceps52
 CASTROvieJO Corneal Scissors85-86, 88
 CASTROvieJO Corneal Section Scissors85
 CASTROvieJO Corneoscleral Scissors84, 156
 CASTROvieJO Cyclodialysis Spatula23, 154
 CASTROvieJO eye Speculum4-5, 154
 CASTROvieJO fixationforceps65
 CASTROvieJO forceps44, 50, 52, 65, 144-146, 148, 150, 153-154
 CASTROvieJO Keratoplasty Scissors88
 CASTROvieJO I acrimal Dilator122, 153
 CASTROvieJO needle Holder116-117, 148, 150-154, 156
 CASTROvieJO Spatula22, 152
 CASTROvieJO Suturingforceps50, 145-146, 148, 150, 153-154
 CASTROvieJO universal Corneal Scissors85
 Cataract Knives14
 Chalazion Curettes21
 Chalazionforceps62-64
 Chalazion Surgery Set151
 CHAnDle R (Gill) iris forceps53
 CHAnG DuO Quick Chopper28, 156
 Chisels126
 Chopper27-28, 44
 Cilia forceps60-61
 Clamps78-81, 153
 CIAYMAN intraocularlens Holdingforceps47
 CIAYMAN lens Holdingforceps47
 CIAYMAN nucleus Rotator28
 CIAYMAN-JAffe lens Manipulating Hook34
 Cleaning & Care136-142
 Clip Applying forceps81
 Clips81
 CIODiuS Orbital Retractor10
 COBAu GH eye Dressingforceps56
 COBAu GH iris forceps56
 Colibri forceps52

Color bands
 Color Tapes
 CombinedeCCe Set
 Combo Prechopper44
 Conjunctival Scissors86-87
 Controller30
 CONve RSe (Wil MeR) Conjunctival & utility Scissors87
 COOK eye Speculum3
 Corneal Dissector15
 Corneal forceps51-52, 57, 68
 Corneal Hook36
 Corneal Knives & Dissectors15
 Corneal Scissors83-86, 88
 Corneal Shields12
 Corneal Spud16
 Corneal Transplant Set148
 Corneoscleral Scissors84
 Crystdens forceps45
 CuMMInG Crystdens forceps45
 Curettes21
 Cutting Platform31, 144, 146
 Cyclodialysis Spatula23
 Cyclodialysis Spoon & Spatula23
 Cystotome16

D

DAviel lens Spoon41
 DAViS foreignbody Spud16
 DeAn Knife-needle15
 DebAKey-Adson Tissue forceps71
 DeSMARReS Chalazionforceps64
 DeSMARReS Corneal Dissector15
 DeSMARReS lid Retractor9, 150
 DeSMARReS lid Retractor,insulated9
 DeWeCKeR iris Scissors97
 Dieffenb ACH Serrefine80, 148, 152, 154
 DieTHRICH Micro bulldog Clamp80
 Dilators122
 Disposablebipolar Cord75, 144-146, 150, 154
 Disposableblades134
 Dissection Knives14
 DiX foreignbody needle18
 DiX foreignbody needle & Gouge18
 DiX foreignbody needle & Spud18
 DiX foreignbody Spud17, 18
 DODiCK iOI folding forceps46, 144, 146
 DODiCK nucleus Cracker45, 144-145
 DOUGIAS Cilia forceps60
 Dressingforceps53-57, 68-70, 72, 153
 DReWS needle Holder115, 144-145
 DRYSDAle nucleus Manipulator30

e

eCCe SeT (Combined)144
 eCCe SeT (Phacoemulsification)145
 elevators23-24, 126
 elli S foreignbody Spud17
 el SCHNiG fixationforceps66
 endocapsular Controller30
 entropiumforceps62
 enucleation Scissors87, 155
 enucleation Scoop41
 enucleation Surgery Set155
 enzymatic Cleaner136
 eRHARDT lid forceps62, 150
 evisceration Spoon41
 expressor38
 extra-Capsulaforceps43-44
 eye Dressingforceps53-57, 68-70, 72, 153
 eye Magnet19
 eye Magnet & foreignbody loop19

ALPHABATIC INDEX



eye Scissors, probe tips102-103
 eye Shields12
 eye Suture (GRADle) Scissors92-93, 104
 eye Suture Scissors92-93, 104
 eyelid Retractors9-10
 eZ-ZyMe ®All Purpose enzyme Cleaner136

f

fascia needle12
 fAul KneR lens Holdingforceps48
 feASTeR Speculum2
 feID blepharoplastyforceps73
 fen Zl lens Manipulating Hook34-35
 fine Stitch Scissors103
 fine -THORTOn Swivel fixation Ring39,
144-145, 149
 finger Held Retractors9-12
 fi SHeR-SMITH iris Spatula22
 fi SHeR Spoon & needle22, 41, 152
 fixationforceps51, 57, 65-66
 fixation Hook36
 fixation Ring39
 flap elevator23-24
 flap Manipulator23-24
 flexibleneck Rake Retractors11
 flexible Stainless Ruler131
 fOeRSTeR eye Dressingforceps55
 fOeRSTeR iris Tissueforceps55
 fOMOn ball end Retractors10
 fOMOn Periostealelevator126
 forceps43-75
 foreignbody forceps58-59, 68
 foreignbody Gouge18-19
 foreignbody instruments16-19, 58-59, 68
 foreignbody loop19
 foreignbody needle18
 foreignbody Spuds16-18
 fragmentforceps45
 fRAnCiS Chalazionforceps64, 151
 fReeR Chisel126, 153
 fReeR elevator126, 153
 french Patternl acrimal Probe123
 fRieDMAn Rongeur124
 fu CHS extra-Capsularforceps44

G

GASKin fragmentforceps45
 GASS Retinal Detachment Hook39, 154, 158
 Gauge131
 GeRZOG Mallet128, 153
 Gill (CHA nDle R) iris forceps53
 Gill Corneal Knife15
 Gill iris forceps52
 Gill -HeSS iris forceps53
 Gill S Capsulotomy Scissors83
 Gill S-vAnnAS Scissors94
 GiRARD Synechia Spatula25
 Glaucoma Surgery Set147
 Globe fixation Ring39
 GOIDMA n-FOX Scissors108-109
 GOIDST ein l acrimal Sac Retractor8
 Golf Clubforeignbody Spud17
 Goniotomy Knife16
 Gouge18-19, 126
 GRADle Cilia forceps61
 GRADle Scissors92-93, 104
 GRAefe eye Dressingforceps56
 GRAefe fixationforceps65
 GRAefe iris forceps56
 GRAul iris Scissors102
 GRAul Tissue forceps73
 GRAZeR blepharoplastyforceps73

GReen fixationforceps, T-Shape65
 GReen needle Holder & Suturingforceps118
 GReen Spatula22, 152
 GReen Strabismus Hook38, 152
 GReenbe RG PAR Scissors, TC111
 GRiffi THS-bROWn Tissueforceps71
 Guard/cap replacement32, 34-35
 GuTHRIe fixation Hook36, 150
 Guy TON-PARK eye Speculum6

H

HAlle (T ieCK) infantnasal Speculum127
 HAISTeD Mosquitoforceps77-78, 150, 153-156
 HARMOn fixationforceps66
 HARMs Tying & Suturing forceps49, 152
 HARMs Colibri forceps52, 148, 156
 HARTMA n Mosquito forceps77, 144-145,
147-148, 152, 156
 HAYne S Suture Scissors105
 HeATH Chalazion Curette21
 HeATH Chalazion forceps63
 HebRA Chalazion Curette21
 Hemostats77-81
 HeRZIG IASiK elevator &
 Retreatment Spatula24, 149
 HeSS-Gill iris forceps53
 HiRSCHMA n iris Hook36
 HiRSCHMA n lens Spatula24
 HOmMAn -THORTOn Globe fixation Ring39
 HOOD iris Scissors, TC101
 HOOD Micro Dissecting Scissors108
 HOOD Micro Stitch Scissors107
 Hook with Retractor12, 37
 Hooks10-12, 34-38
 HOSfORD foreignbody Spud17
 HOSfORD l acrimal Dilator122
 Hun Kele RiOl Manipulator32
 HunT Chalazionforceps63, 151

I

implantationforceps45
 inAMuRA Capsulorhexis forceps43, 144
 infantlid Speculum2
 instrument Cables75
 instrument Care & Cleaning136-142
 instrument Care Kit System137
 instrument Care Training D vD137-138
 instrument Guards139
 instrumentlubricant136-137
 instrument Marking Products138-139
 instrument Prepenzyme foam136
 insulated Retractors9
 intraocularlens forceps45-48
 iOl forceps45-48
 iOl Manipulating Hooks34-35
 iOl Manipulator32, 34-35
 iris forceps50, 52-57, 155-156
 iris Hooks35-36
 iris Operating Scissors103
 iris Scissors93-103, 144, 146-147,
150-151, 153-154, 156
 iris Scissors, SC100
 iris Scissors, SC/TC100
 iris Scissors, TC98, 100-101
 iris Spatulas22
 iris utility Scissors101
 irrigation Cannula144-145, 147-148,
150, 152-154, 156, 158

J

JAbAley Scissors, SC112
 JACObSO n Micro Mosquito forceps77
 JAeGeR lid Plate10, 150-151
 JAffe lens Manipulating Hook34
 JAffe lens Spatula24
 JAffe Stitch Scissors103, 148
 JAffe Tying forceps49
 JAffe-beChERT nucleus
 Rotator28, 144-145, 156
 JAMeSO n Caliper131
 JAMeSO n Recession & Musclforceps64
 JAMeSO n Strabismus Hook38, 152
 JAnSen Dressing forceps72
 Jeweler Styleforceps58-59, 74
 Jeweler'sbipolar forceps74, 144-146, 150, 154
 JOHnS HOPKInS bulldog Clamp79-80
 JOnES Towel Clamp78, 144-145,
147-148, 150, 156
 JOSePH Periostealelevator126

K

HiRSCHMA n iris Hook36
 KAnSAS nucleus bisector30, 144, 146
 KAnSAS nucleus Trisector31
 KAnSAS nucleus vectis31, 146
 KASDA n Retractor9
 KATZin Corneal Transplant Scissors83
 KAWAMOTO Double ended Retractor9
 KAYe blepharoplasty Scissors111-112
 Kell An Capsulorhexis forceps43
 Kel MAn-MCPHeRSON forceps49, 144-145
 Keratoplasty Scissors88
 KeRRISOn Rongeur125, 153
 Kilne R (RAGnell) Scissors110
 KiRBy Cornea-Scleral forceps57
 KiRBy fixationforceps57, 66, 152
 KiRBy iris forceps57
 KiRBy Muscle Hook & expressor38
 KITS144-156
 KnAPP (ROlle T) Retractor11, 150, 153
 KnAPP Cataract Knife14
 KnAPP eye Speculum4
 KnAPP iris Scissors102
 KnAPP Knife- needle14
 KnAPP l acrimal Sac Retractor11, 153
 Knife Handles133, 144-147, 150, 152-154, 156
 Knives14-18
 Knives-needles14-15
 KnOlle iris Hook36
 KOCH nucleus Spatula25
 KOCH Phaco Manipulator & Splitter27
 KRAff -uTRATA Capsulorhexis
 forceps43, 145, 146, 156
 KRATZ lens Holdingforceps48
 KRATZ Style Speculum1, 6
 KRATZ-bARRAQueR Speculum1
 KRITZinGeR-uPDeGRAff IASiK flap23, 149
 KuGlen iris Hook & lens
 Manipulator35, 144-146
 KuRTH Sutureforceps67

I
 IA GRAnGe Sclerectomy Scissors108
 l acrimal Dilators122
 l acrimalinstruments8, 11, 122-128
 l acrimal Probes123-124
 l acrimal Retractors8, 11
 l acrimal Surgery Set153
 IAMBERT Chalazionforceps63
 IAnCASTeR eye Speculum4, 155

I aser eye Shields	12, 150	Micro Clips	81	PAR needle Holder	
IASiK flap elevator	23-24	Micro fRieDMAn Rongeur	124	PAR Scissors	110-111
IASiK flap Manipulator	23-24	Micro iris Scissors	95, 98	PATOn needle Holder	118
IASiK forceps	48	Micro Mosquito forceps	77	Periostealelevators	126
IASiK Retreatment Spatula	23-24	Micro Scissors	98	PeROne IASiK forceps	48
IASiK Spatula	23-24	Micro Surgeryneedle Holders	115-116	Phaco Chopper	27-28, 44
IASiK Surgery Set	149	Micro Sutureforceps	50-51, 54-55, 59	Phaco Manipulator	27
Ie MPeRT Rongeur	125	Micro vAnnAS Scissors	95	Phaco Splitter	27
Iens Holdingforceps	47-48	Micro vessel Clips	81	Phacoemulsification Set	145
Iens Hooks	34-35	Microsurgical Plastic Tray/Mat	141-142	Phacofracture Set	146
Iens loop	41	MilTeX-CASTROvieJO needle Holder	117	PieRSe Colibri Cornealforceps	52, 144-145,
Iens Manipulating Hooks	34-35	MilTeX-vAnnAS Scissors	94, 147	147-148, 156
Iens Spatula	24	MilTeX blepharoplasty Scissors	112	Pigtail Probe	124
Iens Spoon	41	MilTeX Care & Cleaning	136-142	PiSACA nO nucleus Rotator	29
Ie STeR fixationforceps	66, 152	MilTeX extra-Capsularforceps	43	Plain Wireeye Speculum	2
Ie STeR iOl Manipulator	32, 144-145	MilTeX eye Magnet	19	Plastic Tray/Silicone Mat	141-142
Ie WiS Iens loop	41	MilTeX Hook	38	Prechopper	44
Iid forceps	62-64	MilTeX iris Scissors	98	PRinCe Trachomaforceps	64
Iid Retractors	9-10	MilTeX Mallet	128	Probe Tipeye Scissors	102-103
Iid Surgery Set	150	MilTeX Micro Surgeryneedle Holders	116	Probes	123-124
Iiebe RMAne eye Speculum	5-6, 144-146,	MilTeX Stitch Scissors	105	Procedure Sets	144-156
.....	148-149, 152	MilTeX Tray with Silicone Mat	141-142, 144-156	Ptosis forceps	62
Iiebe RMAne Micro Ringlens forceps	46	MilTeX utility Scissors	107	R	
Iiin DneR Cycloclialysis Spoon & Spatula	23	Miniatureblade Handle	133, 144-147,	RAGnell (K ilne R) Scissors	110
Ii PPMAn nucleus Spatula	25	150, 152-154, 156	Rake Retractors	11
Ii STeR Dissectingforceps	73	MOSBy utility Scissors	107	Recession & Musclforceps	64
Ii TTAueR Cilia forceps	60	Mosquitoforceps	77-78	ReeH Stitch Scissors	105
Iive RnOIS iOl folding forceps	46, 144-145	MulDOO n l acrimal Dilator	122	RenTSCH "boat Hook" lens Manipulator	35
Iloop	19, 41	MuRDOCK eye Speculum	3	Replacement guard/cap	32, 34-35
IORnA non-Perforating Towel Clamp	79	Muscle & Recessionforceps	64	Retinal Detachment Hook	39, 154, 158
Iubricants	136-137	Muscle Hook	38	Retractor with Hook	12, 37
Iu CAe Dressingforceps	72	n		Retractors	8-12, 37
M		nAGAHARA nucleus Spatula	25	Retreatment Spatula	23-24
MACHAT IASiK Retreatment Spatula	24, 149	nAGAHARA Phaco Chopper	27-28, 156	Reyn OIDS Scissors	109
Magnet	19	nASA l A PPROACH eye Speculum	2	RiCH Corneal Transplant Scissors	84
Mallets	128	nasal Speculum	127-128	Ring lens forceps	46
MAIOney iOl Manipulator	32	needle	12, 14-15, 18, 22, 41	ROlle T (KnAPP) Retractor	11, 150, 153
MAITZMAN-fen Zl lens Manipulating Hook	35	needle Holders	114-120	Rongeurs	124-125
MANHATTA n eye & eAR		needles-Knives	14-15	ROSen Phaco Splitter	27, 144-145
Suturing/ fixationforceps	51, 151	nOyeS (ROSS) iris Scissors	96	ROSS (nOyeS) iris Scissors	96
Manipulator	23, 27, 29-30, 32, 34-35	nOyeS iris Scissors	96	Rotator	28-29
Manual Phacofracture Set	146	nucleus bisector	30	ROWen Phaco Splitter Combo	27
Markingbands & Tapes	138-139	nucleus Cracker	45	RueDeMann infantl acrimal Dilator	122
Mats	140-142	nucleus instruments	25-32, 45, 144-146, 156	Rulers	131
MAuMenee-PARK eye Speculum	6	nucleus Rotator	28-29		
McClu Re iris Scissors	97	nucleus Spatula	25		
McCull OuGH Suturingforceps	51, 67	nucleus Trisector	31, 144, 146		
McCull OuGH utilityforceps	51, 67	nucleus vectis	31		
McGAnn On Hook & Retractor	12, 37	nuGenT Hook	37		
McGuiRe Corneal Scissors	86	nuGenT utilityforceps	67, 154		
Mcintyre Speculum	3	nylon & Stainless Steebrushes	138		
McPHeRSON Micro Corneal Suturing		nylon Cap Replacement	128		
forceps	51	O			
McPHeRSON Micro iris Suturing		O'bRien fixationforceps	66		
forceps	50, 150	O'bRien Stitch Scissors	106		
McPHeRSON needle Holder	115	O'COnn OR Hook	37		
McPHeRSON Tissueforceps	50	O'COnn OR iris forceps	55		
McPHeRSON Tying forceps	49, 154	ObSTbAuM Synechia Spatula	24		
McPHeRSON-vAnnAS Micro iris Scissors	95	OIMSTeAD Tissue forceps	73		
McPHeRSON-WeSTCOTT		OISen-HeGAR needle Holder	120		
Conjunctival Scissors	86	Orbital Retractor	10, 11		
McPHeRSON-WeSTCOTT		OSHeR utility Hook	36		
Stitch Scissors	104, 147	OSHeR y-Hook lens Manipulator	35		
Melle R l acrimal Sac Retractor	8	P			
Mellin GeR eye Speculum	4, 147	PADGeTT-CASTRO vieJO needle Holder	117		
MenDeZ Multi-Purpose IASiK forceps	48	PADGeTT-STEVEN S Tenotomy Scissors	89-91		
MeTZenbAuM Scissors	109-110, 156	PADGeTT blepharoplasty Scissors	112		
MeyerHOefe R Chalazion Curette	21, 151	PADGeTT iris Scissors	93-94, 96, 98, 100-102		
Micro (Jeweler)forceps	58-59, 74	PADGeTT iris Scissors, TC	98, 100-101		
Micro ADSO n Dressing forceps	57, 69	PADGeTT Strabismus Scissors	88		
Micro ADSO n Tissueforceps	57, 69, 156	PADGeTT Suture/Stitch Scissors	105		
Microboley Gauge	131				
Micro Clamps	79-81				
Micro Clip Approximator Set	81				

ALPHABATIC INDEX



SinSKey ii lens Manipulating Hook34, 156
 SinSKey lens Manipulating Hook34
 SKeele Chalazion Curette21
 SIADe IASiK Retreatment Spatula23, 149
 Sleeve Spreadingforceps75, 154
 Sli Mline Series140
 SMITH Corneal Protection Shields12
 SMITH-fi SHeR iris Spatula22
 Snellen entropiumforceps62
 Spatulas22-25
 Specula1-6, 127-128
 SPenCeR Chalazionforceps63
 SPenCeR Stitch Scissors106
 Splinterforceps58-59, 68
 Splitter27
 Spoon22-23, 41
 Spoon & needle22
 Spoon & Spatula23
 Spray lube136
 Spud16-18
 Stain Remover137
 Stainless Steel Surgical blades134
 Sterilizing Trays140-142
 STeRn-Gill S Scissors95, 144-145
 STEven S iris forceps55
 STEven S Tenotomy Hook37, 152
 STEven S Tenotomy Scissors89-91, 150, 153-155
 STEven SO n l acrimal Sac Retractor8, 153
 Stitch/SutureScissors92-93, 103-107
 Storage Cassettes140-142
 Strabismusforceps57
 Strabismus Hooks38
 Strabismus Scissors88-89
 Strabismus Surgery Set152
 Suction Handle12
 Surgicalblades134
 Surgicalinstrument Cleaner136
 Surgicalinstrument Cleaner & lubricant137
 Surgicalinstrument Stain Remover137
 Suture/Stitch Scissors92-93, 103-107
 Suturingforceps49-52, 59-61, 67, 70
 SWISS Cilia & Sutureforceps60
 SWISS Jeweler Styleforceps58-59, 74
 Swivel fixation Ring39
 Synechia Spatula24-25

T

T-Shape fixationforceps65
 TApe n' Tell TM Adhesive Strips139
 TeMPORAl Approach Speculum2, 144-145
 Tenn AnT nucleus Rotator29
 Tenn AnT Tying forceps49, 144-145, 148
 Tenotomy Hook37
 Tenotomy Scissors89-92
 THOMAS iris Scissors101
 THORPe Caliper131
 THORPe Corneal & Splinterforceps68
 THORTOn Globe fixation Ring39
 TieCK (HAlle) infantnasal Speculum127
 TIP-iT TM instrument Guards139
 Tonometer130
 TOOke Corneal Knife15
 Towel Clamps78-79, 144-145, 147-148, 150, 153, 156
 Trachoma forceps64
 Trays141-142
 Trephine127
 Trisector31, 144, 146
 TROuTMAn-bARRAQueR blade breaker134
 TROuTMAn-bARRAQueR Colibriforceps52, 156
 TROuTMAn-CASTROvieJO Corneoscleral Scissors84
 TROuTMAn-KATZin Corneal Transplant Scissors83, 148
 Tying forceps49-52, 67, 70
 TyRel Hook37

U

universal Cassette & Mats140-142
 universal Prechopper44
 uPDeGRAff-K RiTZinGeR I ASiK23
 uRibe-STeRn Scissors95
 uTHOff -Gill S Capsulotomy Scissors83
 utilityforceps67-68
 utility Hook36
 utility Scissors87, 101, 107
 uTRATA -KRAff Capsulorhexis forceps43

V

vAnnAS Capsulotomy Scissors83
 vAnnAS Scissors83, 94-95, 144-145, 147
 vessel Clips81
 veterinary Ophthalmic Surgery Set156
 video on instrument Care137-138
 vienn A nasal Speculum127-128, 153
 viscoelastic Aspirating Cannula154, 158
 vitreoretinal Surgery Set154
 vOn GRAefe (beCKeR) Cystotome ...16, 144-145
 vOn GRAefe Cataract Knife14
 vOn GRAefe Strabismus Hook38, 150, 152, 154-155
 vOn GRAefe Tissue forceps65

W

WAID eAu fixationforceps65
 WAIKeR iris Scissors101
 WAITeR Corneal Spud16
 WAITOn foreign body Gouge19
 WATZK e Sleeve Spreadingforceps75, 154
 WebSTeR needle Holder119-120
 WeCKeR iris Spatula22
 Well S enucleation Scoop41, 155
 WeST I acrimal Sac Chisel/Gouge126, 153
 WeSTCOTT-McPH eRSON Scissors86
 WeSTCOTT Stitch Scissors104, 107, 147, 150, 152-154
 WeSTCOTT Tenotomy Scissors92, 144-148, 150, 152, 154, 156
 WHeele R Dissection Knife14
 WieneR Corneal Hook36
 WieS Chalazionforceps64
 WiID eR Cystotome16
 WiID eR I acrimal Dilator122
 WiID eR lens loop41
 Willi AMS eye Speculum5
 Willi AMS I acrimal Probe123
 Will S HOSPITAL utilityforceps67
 Wil MeR (CO nve RSe) Conjunctival & utility Scissors87
 Wil MeR (CO nve RSe) Conjunctival Scissors87
 WORST Pigtail Probe124, 153
 WRIGHT fascia needle12

Y

y-Hook35

Z

Z-Type Retractor10
 ZAID ivAR Microimplantationforceps45
 ZAReM-bAyli S eyelid Retractor10
 ZieGle R Cilia forceps60
 ZieGle R Knife-needle14
 ZieGle R I acrimal Dilator122

**Pakistan Address:****Address:**

No 665 Naaz Street K LW Sialkot 51310

Email:

info@frizkontools.com

Contact:

+923314494637

+923325334864

+0523306091

Website:

www.frizkontools.com

Ireland Address:**Address:**

35 Belmont Middle Gardiner Street

Dublin D01C447

Email:

info@frizkontools.com

Contact:

+353831052805

Website:

www.frizkontools.com

Ireland Address:**Address:**

13626 Near Point Tomball TX77377

Email:

info@frizkontools.com

Contact:

+1 (832) 686-3125

Website:

www.frizkontools.com

Please call Customer Service today for additional information, an in-office demonstration, to place an order or to receive other Frizkon catalogs.

Illustrations and content provide general description only and may be subject to change.

Frizkon, Frizkon Redefining Excellence, Carb-N-Sert and EZ-Zyme are registered trademarks of Aphrodite Surgical, a subsidiary of Integra LifeSciences Corporation. Silitone, Tape N'Tell, Tip-It, and Tuck-Away are trademarks of Frizkon, Inc.

The Padgett logo is a registered trademark of Integra LifeSciences Corporation. Padgett is a trademark of Integra LifeSciences Corporation.

The Integra wave logo is a trademark of Integra LifeSciences Corporation.

Copyright ©

