

PLASTIC SURGERY



2023



info@frizkontools.com
www.frizkontools.com



PLASTIC SURGERY INSTRUMENTS *Changes*

FRIZKON TOOLS

Established in 2006 **FRIZKON TOOLS** provides premium solutions for exceptional value to individuals and businesses. We are the third generation Ophthalmic, Electro Surgical and Plastic Surgery Instruments manufacturing company. Frizkon portfolio encompasses an experience of over 15 years to introduce technological advancements through wide range of product, we gather our strength from creative thought processing, strategic marketing techniques and experience of a team of individuals talented by nature and trained by the profession. Position ourselves to be regional players of quality making products, improve on contemporary measure including cost, quality, service, speed of delivery and mobilization. We are customer driven we go the extra mile to make sure our clients exceptions are met and exceeded on every issue. Experience has shown that most clients prefer to work with our company rather than having many suppliers / companies. To achieve this, Frizkon have brought all your technological needs under one roof, we make sure that all our processes and methods conform to the highest ideals of professional behavior. The commitment to excellence make us a world class well known company for our high quality standards from design to finished products and from sales to shipment all procedures and processes are organized to give our customers reliable products and a convenient and punctual services. After years of expertise and experience, we still remain dedicated to continuous business and personal development, building strong customer relations and investing in research and development, Innovative ideas and personal dedication combined with high quality products is our specialty, our commitment of introducing quality products combined with honest, reliable service has proven to be a successful theory in ensuring the continued rapid growth of the company. Our transparent business policies together with highly professional and values are sheet anchor of our company management.

FEATURES OF OUR QUALITY CONTROL PROCEDURES



FRIZKON
INTERNATIONAL

1:- MATERIALS

Choosing material is the main factor in the manufacturing process normally best kind of stain less is used in manufacturing the items, but other kind of French and Japanese steel and a series of 300 / 410 and 420 are also used as per the customer requirements PQA is the competent authority for the testing of raw materials, A rigid quality control policy is being adopted before releasing to the production process. Material test is to check the standard of steel as per desired specification and requirement of the customers.

2:- FORGING AND HAMMERING

Hot and cold forging is performed to the raw material (stainless steel bars) for the standard press operations in forming deep drawing of all type of instruments thru the specialized craftsmen. They annealed the forging process and prepare the materials for milling process.

3:- MILLING PROCESS.

Milling process is performed by the highly skilled machinist they are fully trained in accurately forming the male-female portions of box-joints forceps as well as serrations- retches and other wide range of instruments in uniformity. Almost all types of mechanical works are performed at the same place.

4:- FILLING.

Hand-made fabrication makes almost all items precise and finest in look and that is done by specialized and skilled persons who assemble male /female portions after adjusting of extracting forceps and scissors, tips, serrations, retches and all other type of items in uniformity and file precisely to make it semi-finish under strict quality control specifications.

5:-TEMPERING

All instruments are being tempered maintaining "Rock-Well Hardness". The tempering varies from 45 to 55 for various types of instruments. A hardness test is taken after tempering of each lot to maintain the uniformity. Further Passivation or a chemical process is performed to clean the items chemically.

6:- RIVETING

A wide range of assembly operation is performed from prototype quantities to production run. Each instrument is riveted / welded or spot welded precisely according to the requirement.

7:- GRINDING / POLISHING

Finally, to get the best finished products it is necessary to facilitate the craftsman with précised grinding and polishing equipment's for high uniformity utilizing best of polishing luster. Electro-plating and glass head process is used for the shined and matt finished steel instruments.

We are proud to say that Let us serve you to the best of our abilities.

For any query, call or mail us: info@frizkontools.com or visit www.frizkontools.com

FRIZKON INTERNATIONAL

Contact:- +92 52 3306091

+92 3325334864

+92 3436467358

TABLE OF CONTENTS



AREOLA MARKERS

2



BREAST RETRACTORS

3-13



DISSECTOR & ELEVATORS

14-26



CHISELS & GOUGES

27-31



OSTEOTOMES & RASPATORIES

32-46



MUCOSA KNIFE & RASPATORIES

47



RHINOPLASTY FILES & RASPS

48-51



RHINOPLASTY FORCEPS

52-53



RHINOPLASTY RETRACTORS

54-59



RHINOPLASTY SAWS

60



RHINOPLASTY SEPTUM FORCEPS

61

TABLE OF CONTENTS

RHINOPLASTY SPECULA

62-64

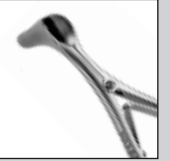

RHINOPLASTY KNIVES

65



GRASPING FORCEPS & HOOK SCISSORS

66



SEPTUM STRAIGHTENING FORCEPS

67-68



MOUTH GAGS

69-70



RETRACTORS

71-78



CYLINDER OSTEOTOMES

79



AURICULAR PLASTIC INSTRUMENTS

80



CARTILAGE AND BONE INSTRUMENTS

81-83



DERMATOMES

84



LIPS AND CHEEKS RETRACTORS

85

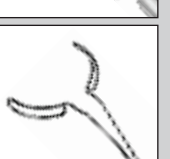

TABLE OF CONTENTS



LIP AND CLEFT PALATE INSTRUMENTS

86-87



MALLETS

88



MARKING AND MEASURING INSTRUMENTS

89-92



BONE INSTRUMENTS

93

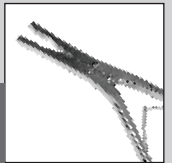

SCALPEL HANDLE

95



SCISSORS

96-106

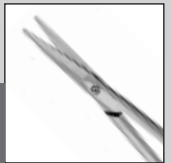

DRESSING AND TISSUE FORCEPS

107-111



HEMOSTATIC FORCEPS

112-114



NEEDLE HOLDERS

115-120



MICRO SURGERY INSTRUMENTS

121-123





GROSSMANN AREOLA MARKER

Item Code	Description
01-001-001	40MM,44MM,48MM, 52MM



FREEMAN AREOLA MARKER

Item Code	Description
01-002-001	2 SIZES, 34MM / 36MM
01-002-002	2 SIZES, 38MM / 42MM
01-002-003	2 SIZES, 42MM / 45MM
01-002-004	2 SIZES, 45MM / 50MM



FREEMAN AREOLA MARKER

Item Code	Description
01-003-001	34MM
01-003-002	36MM
01-003-003	38MM
01-003-004	42MM
01-003-005	45MM
01-003-006	50MM



STAINLESS STEEL

FREEMAN AREOLA MARKER

Item Code	Description
01-004-001	38 MM
01-004-002	42 MM
01-004-003	50 MM
01-004-004	45 MM
01-004-005	34 MM
01-004-006	36 MM



SOLZ AREOLA MARKER

Item Code	Description
01-005-001	BLUNT, 36MM DIAMETER
01-005-002	BLUNT, 40MM DIAMETER
01-005-003	BLUNT, 42MM DIAMETER
01-005-004	BLUNT, 45MM DIAMETER



MARX BREAST RETRACTOR

Item Code	Description
02-001-001	27CM, 125 X 30MM
02-001-002	27CM, 140 X 30MM



FERRIERA STYLE RETRACTOR

Size	With Light Guide & Suction	With Light Guide	Retractor Only	Suction Only
70 X 16 mm	02-002-001	02-003-001	02-004-001	02-005-001
80 X 16 mm	02-002-002	02-003-002	02-004-002	02-005-002
90 X 27 mm	02-002-003	02-003-003	02-004-003	02-005-003
110 X 25 mm	02-002-004	02-003-004	02-004-004	02-005-004
120 X 25 mm	02-002-005	02-003-005	02-004-005	02-005-005
130 X 16 mm	02-002-006	02-003-006	02-004-006	02-005-006
130 X 25 mm	02-002-007	02-003-007	02-004-007	02-005-007
150 X 25 mm	02-002-008	02-003-008	02-004-008	02-005-008
150 X 30 mm	02-002-009	02-003-009	02-004-009	02-005-009
150 X 36 mm	02-002-010	02-003-010	02-004-010	02-005-010
180 X 16 mm	02-002-011	02-003-011	02-004-011	02-005-011
180 X 25 mm	02-002-012	02-003-012	02-004-012	02-005-012
190 X 25 mm	02-002-013	02-003-013	02-004-013	02-005-013
190 X 36 mm	02-002-014	02-003-014	02-004-014	02-005-014
220 X 27 mm	02-002-015	02-003-015	02-004-015	02-005-015

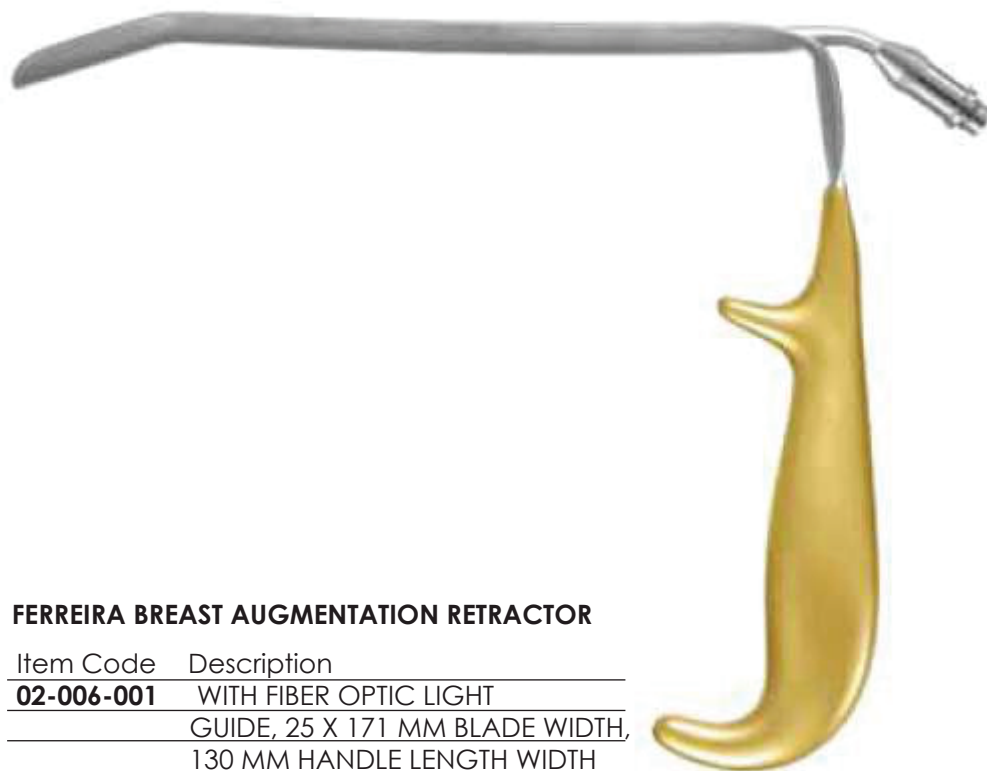

FERREIRA BREAST AUGMENTATION RETRACTOR

Item Code	Description
02-006-001	WITH FIBER OPTIC LIGHT GUIDE, 25 X 171 MM BLADE WIDTH, 130 MM HANDLE LENGTH WIDTH

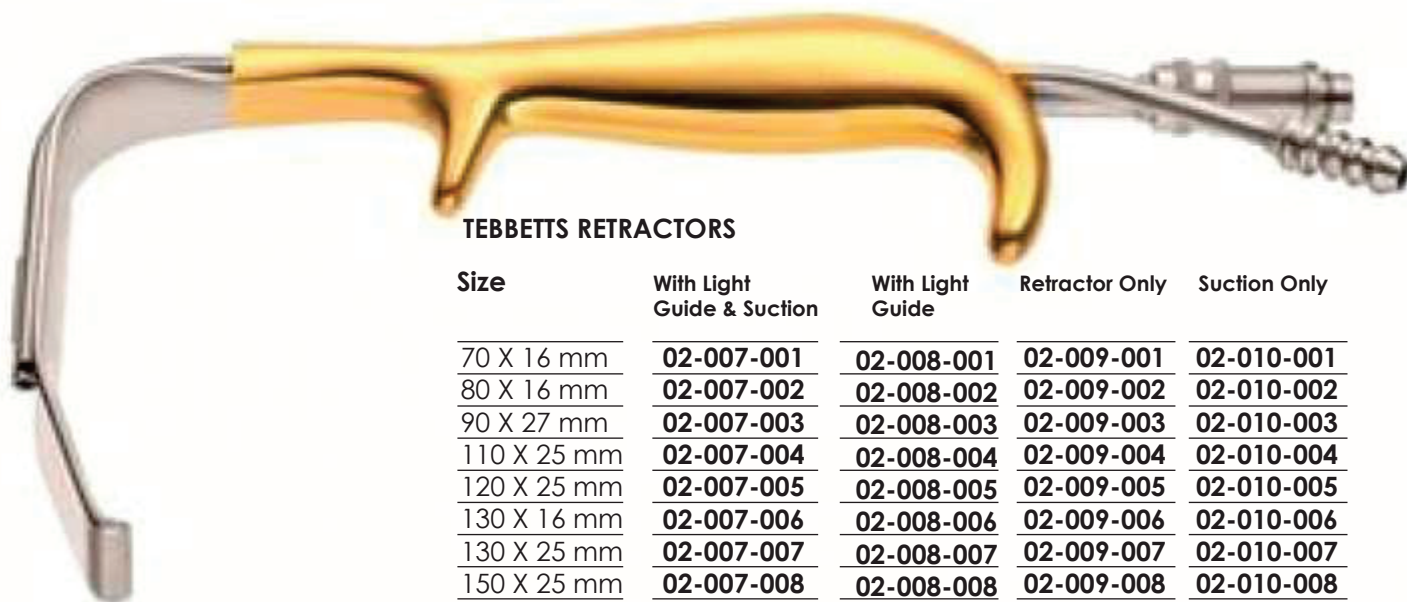

TEBBETTS RETRACTORS

Size	With Light Guide & Suction	With Light Guide	Retractor Only	Suction Only
70 X 16 mm	02-007-001	02-008-001	02-009-001	02-010-001
80 X 16 mm	02-007-002	02-008-002	02-009-002	02-010-002
90 X 27 mm	02-007-003	02-008-003	02-009-003	02-010-003
110 X 25 mm	02-007-004	02-008-004	02-009-004	02-010-004
120 X 25 mm	02-007-005	02-008-005	02-009-005	02-010-005
130 X 16 mm	02-007-006	02-008-006	02-009-006	02-010-006
130 X 25 mm	02-007-007	02-008-007	02-009-007	02-010-007
150 X 25 mm	02-007-008	02-008-008	02-009-008	02-010-008
150 X 30 mm	02-007-009	02-008-009	02-009-009	02-010-009
150 X 36 mm	02-007-010	02-008-010	02-009-010	02-010-010
180 X 16 mm	02-007-011	02-008-011	02-009-011	02-010-011
180 X 25 mm	02-007-012	02-008-012	02-009-012	02-010-012
190 X 25 mm	02-007-013	02-008-013	02-009-013	02-010-013
190 X 36 mm	02-007-014	02-008-014	02-009-014	02-010-014
220 X 27 mm	02-007-015	02-008-015	02-009-015	02-010-015

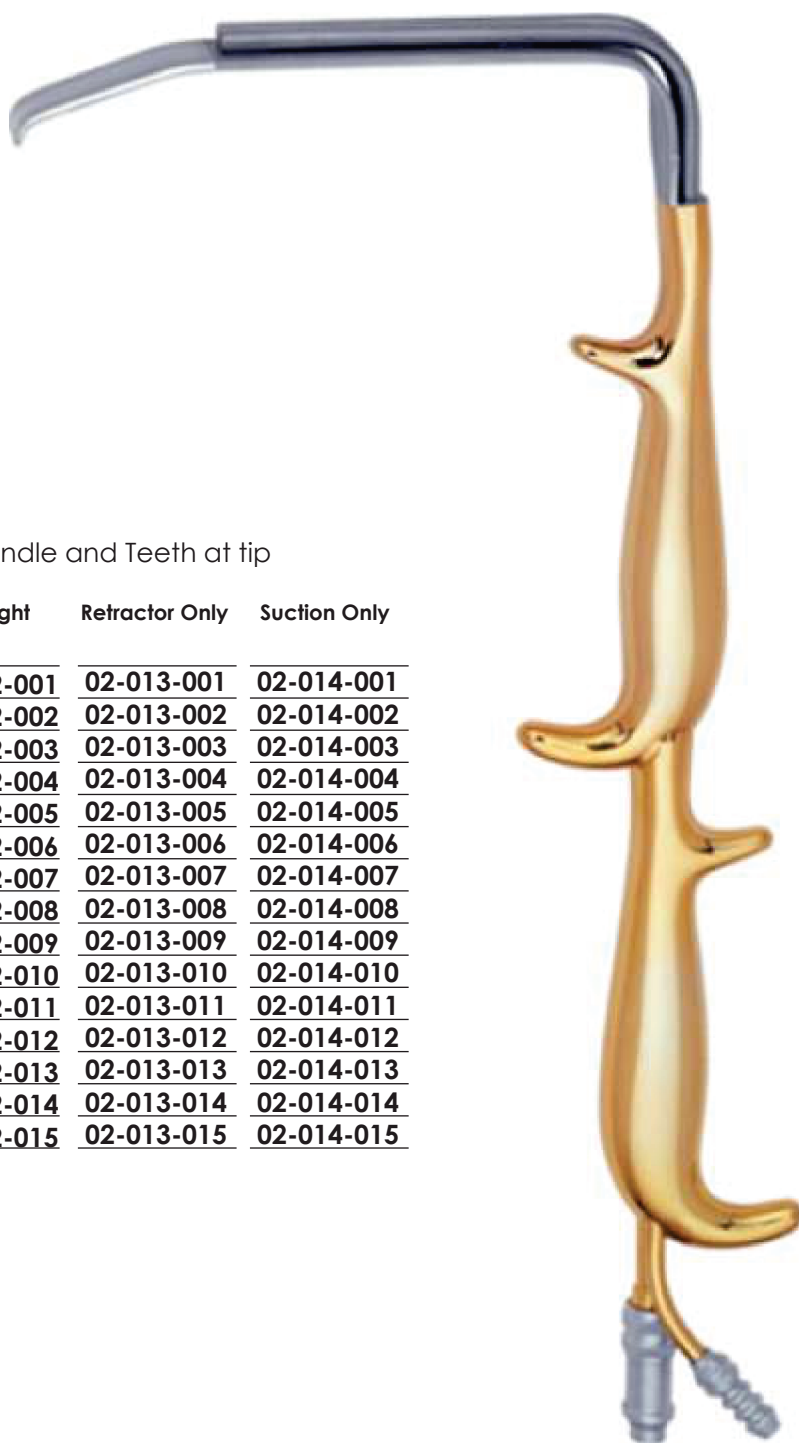

TEBBETTS RETRACTOR, With Double Handle and Teeth at tip

Size	With Light Guide & Suction	With Light Guide	Retractor Only	Suction Only
70 X 16 mm	02-011-001	02-012-001	02-013-001	02-014-001
80 X 16 mm	02-011-002	02-012-002	02-013-002	02-014-002
90 X 27 mm	02-011-003	02-012-003	02-013-003	02-014-003
110 X 25 mm	02-011-004	02-012-004	02-013-004	02-014-004
120 X 25 mm	02-011-005	02-012-005	02-013-005	02-014-005
130 X 16 mm	02-011-006	02-012-006	02-013-006	02-014-006
130 X 25 mm	02-011-007	02-012-007	02-013-007	02-014-007
150 X 25 mm	02-011-008	02-012-008	02-013-008	02-014-008
150 X 30 mm	02-011-009	02-012-009	02-013-009	02-014-009
150 X 36 mm	02-011-010	02-012-010	02-013-010	02-014-010
180 X 16 mm	02-011-011	02-012-011	02-013-011	02-014-011
180 X 25 mm	02-011-012	02-012-012	02-013-012	02-014-012
190 X 25 mm	02-011-013	02-012-013	02-013-013	02-014-013
190 X 36 mm	02-011-014	02-012-014	02-013-014	02-014-014
220 X 27 mm	02-011-015	02-012-015	02-013-015	02-014-015

TEBBETTS RETRACTOR, Insulated Blade with Teeth

Size	With Light Guide & Suction	With Light Guide	Retractor Only	Suction Only
70 X 16 mm	02-015-001	02-016-001	02-017-001	02-018-001
80 X 16 mm	02-015-002	02-016-002	02-017-002	02-018-002
90 X 27 mm	02-015-003	02-016-003	02-017-003	02-018-003
110 X 25 mm	02-015-004	02-016-004	02-017-004	02-018-004
120 X 25 mm	02-015-005	02-016-005	02-017-005	02-018-005
130 X 16 mm	02-015-006	02-016-006	02-017-006	02-018-006
130 X 25 mm	02-015-007	02-016-007	02-017-007	02-018-007
150 X 25 mm	02-015-008	02-016-008	02-017-008	02-018-008
150 X 30 mm	02-015-009	02-016-009	02-017-009	02-018-009
150 X 36 mm	02-015-010	02-016-010	02-017-010	02-018-010
180 X 16 mm	02-015-011	02-016-011	02-017-011	02-018-011
180 X 25 mm	02-015-012	02-016-012	02-017-012	02-018-012
190 X 25 mm	02-015-013	02-016-013	02-017-013	02-018-013
190 X 36 mm	02-015-014	02-016-014	02-017-014	02-018-014
220 X 27 mm	02-015-015	02-016-015	02-017-015	02-018-015

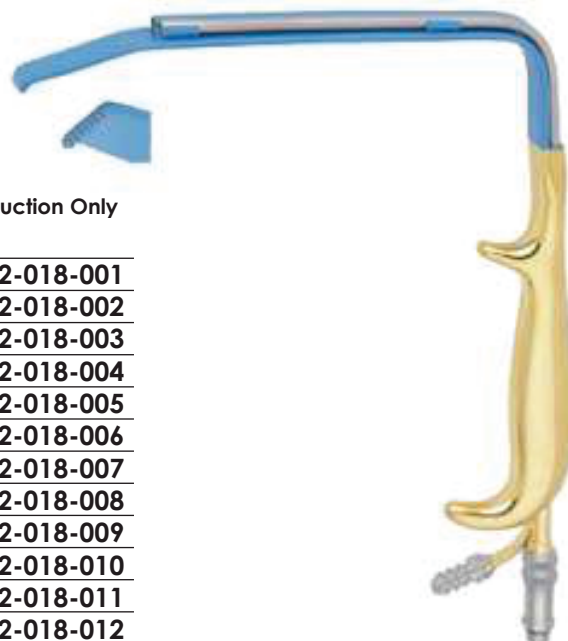

Tebbetts Breast Augmentation Fiber Optic Retractor, Insulated Blade With Smooth End

Size	With Light Guide & Suction	With Light Guide	Retractor Only	Suction Only
70 X 16 mm	02-019-001	02-020-001	02-021-001	02-022-001
80 X 16 mm	02-019-002	02-020-002	02-021-002	02-022-002
90 X 27 mm	02-019-003	02-020-003	02-021-003	02-022-003
110 X 25 mm	02-019-004	02-020-004	02-021-004	02-022-004
120 X 25 mm	02-019-005	02-020-005	02-021-005	02-022-005
130 X 16 mm	02-019-006	02-020-006	02-021-006	02-022-006
130 X 25 mm	02-019-007	02-020-007	02-021-007	02-022-007
150 X 25 mm	02-019-008	02-020-008	02-021-008	02-022-008
150 X 30 mm	02-019-009	02-020-009	02-021-009	02-022-009
150 X 36 mm	02-019-010	02-020-010	02-021-010	02-022-010
180 X 16 mm	02-019-011	02-020-011	02-021-011	02-022-011
180 X 25 mm	02-019-012	02-020-012	02-021-012	02-022-012
190 X 25 mm	02-019-013	02-020-013	02-021-013	02-022-013
190 X 36 mm	02-019-014	02-020-014	02-021-014	02-022-014
220 X 27 mm	02-019-015	02-020-015	02-021-015	02-022-015

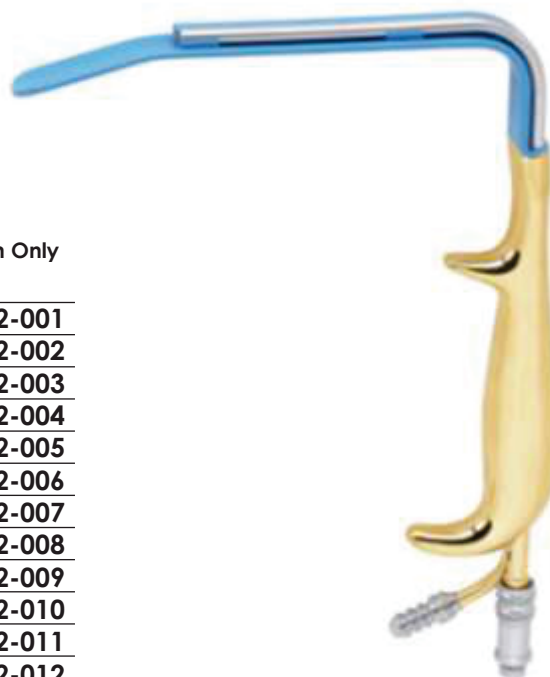

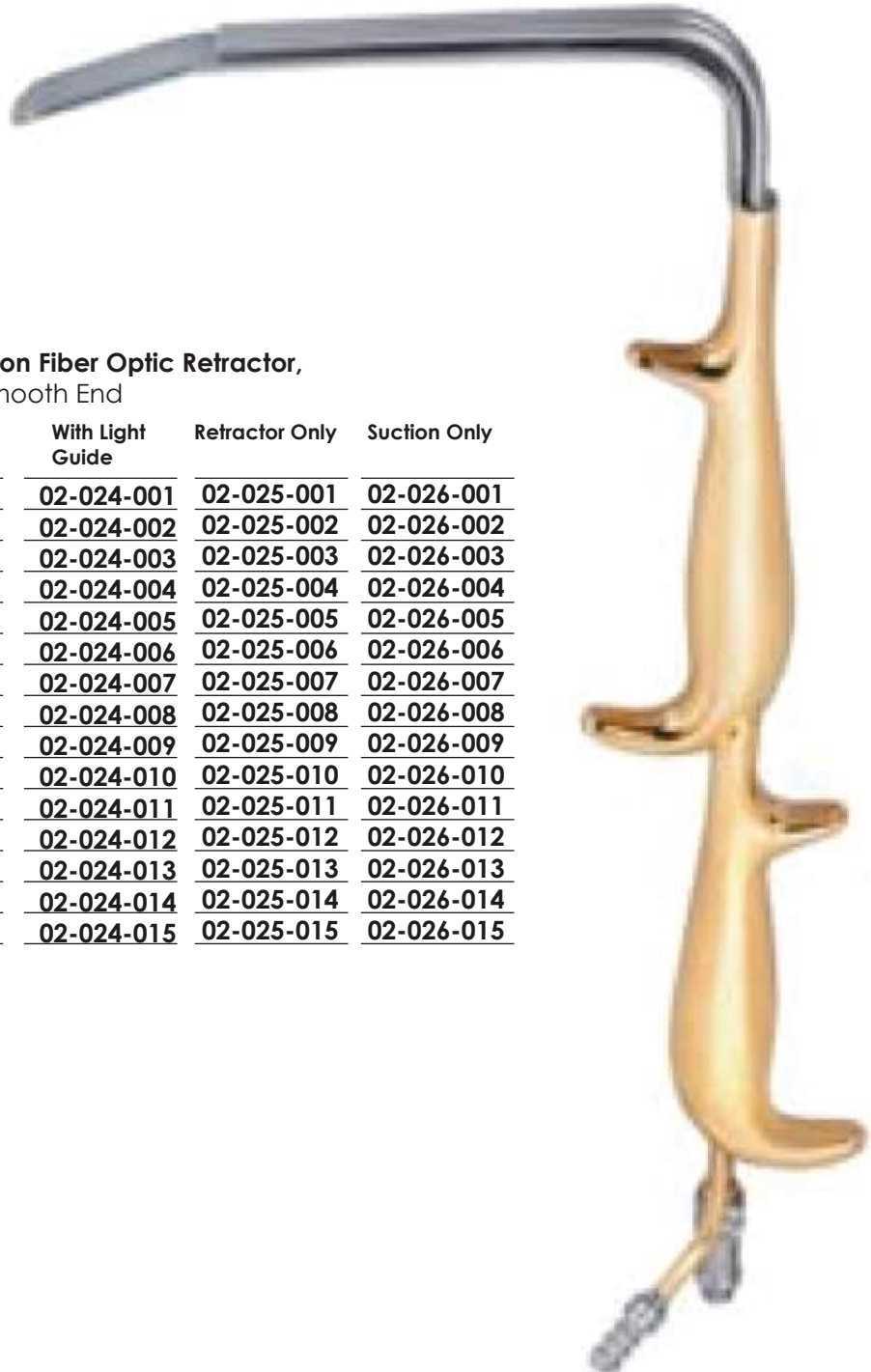

Tebbetts Breast Augmentation Fiber Optic Retractor,
With Double Handle and Smooth End

Size	With Light Guide & Suction	With Light Guide	Retractor Only	Suction Only
70 X 16 mm	02-023-001	02-024-001	02-025-001	02-026-001
80 X 16 mm	02-023-002	02-024-002	02-025-002	02-026-002
90 X 27 mm	02-023-003	02-024-003	02-025-003	02-026-003
110 X 25 mm	02-023-004	02-024-004	02-025-004	02-026-004
120 X 25 mm	02-023-005	02-024-005	02-025-005	02-026-005
130 X 16 mm	02-023-006	02-024-006	02-025-006	02-026-006
130 X 25 mm	02-023-007	02-024-007	02-025-007	02-026-007
150 X 25 mm	02-023-008	02-024-008	02-025-008	02-026-008
150 X 30 mm	02-023-009	02-024-009	02-025-009	02-026-009
150 X 36 mm	02-023-010	02-024-010	02-025-010	02-026-010
180 X 16 mm	02-023-011	02-024-011	02-025-011	02-026-011
180 X 25 mm	02-023-012	02-024-012	02-025-012	02-026-012
190 X 25 mm	02-023-013	02-024-013	02-025-013	02-026-013
190 X 36 mm	02-023-014	02-024-014	02-025-014	02-026-014
220 X 27 mm	02-023-015	02-024-015	02-025-015	02-026-015



Sculpo Breast Retractors

Item Code	Description
02-027-001	180 X 25mm, Blade Size, With 5mm Endoscopic Scope Sheath
02-027-002	180 X 25mm, Blade Size, With 10mm Endoscopic Scope Sheath



Ring breast retractor

Item Code	Description
02-028-001	with fiber optic illumination and irrigation tube



BIGGS MAMMAPLASTY RETRACTOR

Item Code	Description
02-029-001	WITH FIBER OPTIC LIGHT GUIDE 5.0 CM BLADE WIDTH, 20 CM LENGTH



BIGGS MAMMAPLASTY RETRACTOR,

Item Code	Description
02-030-001	3 CM BLADE WIDTH, NARROW, (171 MM) LENGTH

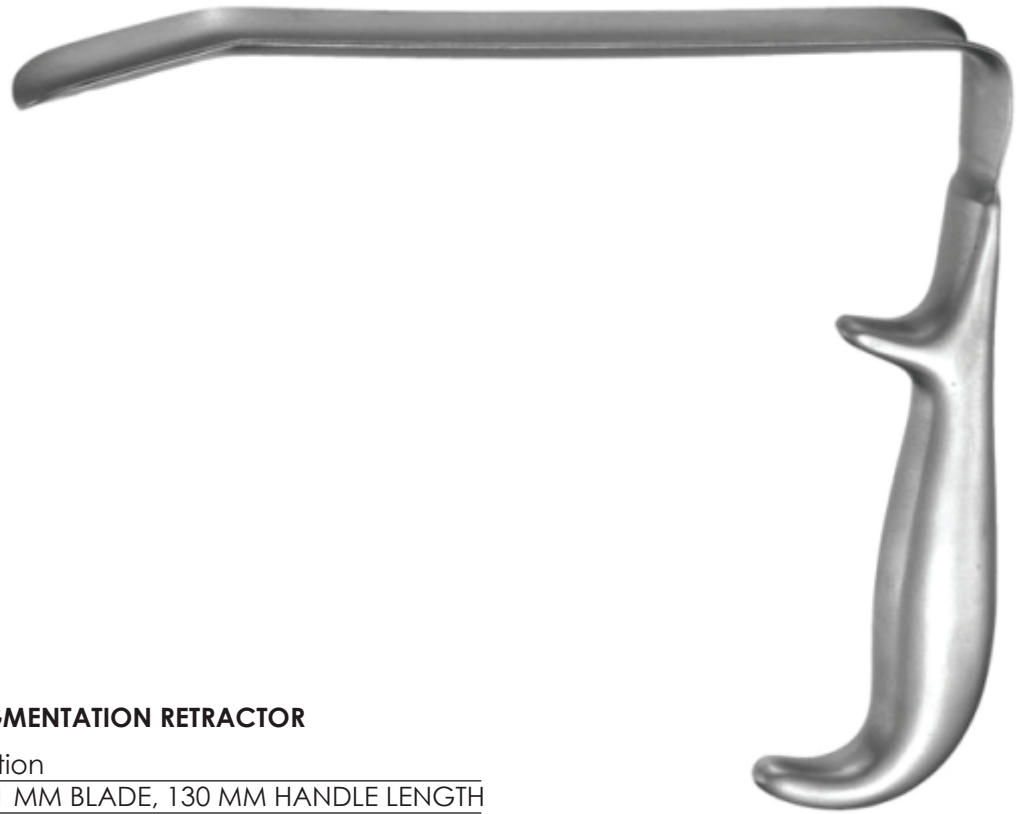

FERREIRA BREAST AUGMENTATION RETRACTOR

Item Code	Description
02-031-001	25 X 171 MM BLADE, 130 MM HANDLE LENGTH

BIGGS MAMMAPLASTY RETRACTOR

Item Code	Description
02-032-001	WITH FIBER OPTIC LIGHT GUIDE, NARROW, 3.0 CM BLADE WIDTH, 15 CM LENGTH





BIGGS MAMMAPLASTY RETRACTOR

Item Code	Description
02-033-001	50 MM WIDTH, STANDARD, 20 CM LENGTH



BREAST RETRACTOR

Item Code	Description
02-034-001	DOUBLE ENDED, (31 CM), BLADES 22MM X 55MM AND 38MM X 70MM
02-034-002	DOUBLE ENDED, (24 CM), BLADES 22MM X 55MM AND 38MM X 70MM



BIGGS MAMMAPLASTY RETRACTORS

Item Code	Description
02-035-001	30MM, WITH FIBER OPTIC LIGHT GUIDE
02-035-002	50MM, WITH FIBER OPTIC LIGHT GUIDE
02-035-003	30MM, WITH FIBER OPTIC LIGHT GUIDE AND SUCTION
02-035-004	50MM, WITH FIBER OPTIC LIGHT GUIDE AND SUCTION



WIEDER BREAST AND FACIAL RETRACTOR / TONGUE DEPRESSOR, WITH FIBER OPTIC LIGHT GUIDE

Item Code	Description
02-036-001	SERRATED, (14 CM), 28MM
02-036-002	SERRATED, (14 CM), 38MM
02-036-003	SERRATED, (15 CM), 45MM



BREAST SPATULA

Item Code	Description
02-037-001	WITH HANDLE 31.5 CM, 25MM X 18 CM BLADE, SERRATED TIP, SEMI MALLABLE



WIEDER BREAST AND FACIAL RETRACTOR / TONGUE DEPRESSOR

Item Code	Description
02-038-001	SERRATED, (14 CM), 28MM
02-038-002	SERRATED, (14 CM), 38MM
02-038-003	SERRATED, (15 CM), 45MM



MACCOLLUM DINGMAN BREAST DISSECTOR

Item Code	Description
03-001-001	31.5 CM
03-001-002	41 CM



MACCOLLUM DINGMAN SUBMAMMARY DISSECTOR

Item Code	Description
03-002-001	30 CM



MACCOLLUM DINGMAN BREAST DISSECTOR

Item Code	Description
03-003-001	1½" (38 MM) WIDTH, 17½" (432 MM) LENGTH



BREAST DISSECTOR

Item Code	Description
03-004-001	SPATULATED BLADE, 33CM
03-004-002	SPATULATED BLADE, 42CM



BREAST DISSECTOR

Item Code	Description
03-005-001	OVAL SPATULATED BLADE, 33CM
03-005-002	OVAL SPATULATED BLADE, 42CM



BREAST DISSECTOR

Item Code	Description
03-006-001	ANGULATED BLADE, 33CM
03-006-002	ANGULATED BLADE, 42CM



REYNOLDS TRANSAUXILLARY BREAST DISSECTOR

Item Code	Description
03-007-001	FENESTRATED, 33CM
03-007-002	FENESTRATED, 40CM



SILVERSTEIN BREAST DISSECTOR

Item Code	Description
03-008-001	14" (356 MM) LENGTH



SPATULA BREAST RETRACTOR / DISSECTOR

Item Code	Description
03-009-001	SERRATED, 12½", SEMI MALLEABLE



PENN BREAST DISSECTOR

Item Code	Description
03-010-001	STRAIGHT, 1" (25 MM) WIDTH, 12¾" (324 MM) LENGTH



MCINNIS POLYCURETTE BREAST INSTRUMENT

Item Code	Description
03-011-001	11 ³ / ₄ " (300 MM) WIDTH, 12 ¹ / ₂ " (318 MM) LENGTH



JACOBS TRANSAXILLARY DISSECTOR

Item Code	Description
03-012-001	CURVED SHAFT CHISEL EDGE 17" (432 mm) WIDTH 1/2" (13mm)



WIESLANDER TRANSAXILLARY BREAST DISSECTOR

Item Code	Description
03-013-001	LENGTH 18 1/8" (460mm) WIDTH 1" (25mm)
03-013-002	LENGTH 17" (432mm) WIDTH 1-3/8" (35mm)



REYNOLDS TRANSAXILLARY BREAST DISSECTOR

Item Code	Description
03-014-001	15 3/4" (400mm) 1 1/2" (38mm)



TROCAR BREAST TUBE

Item Code	Description
03-015-001	14" (356 MM), LARGE, 17.3 MM ID, 19.0 MM OD
03-015-002	13 1/2" (343MM), SMALL, 14 MM ID, 16 MM OD



SOLZ ATRAUMATIC BREAST DISSECTOR

Item Code	Description
03-016-001	34CM
03-016-002	37CM



SOLZ BREAST HOOK DISSECTOR

Item Code	Description
03-017-001	36CM



AGRIS DINGMAN BREAST DISSECTOR

Item Code	Description
03-018-001	SET OF 2, LEFT AND RIGHT, 36CM



ICONOCLAST

Item Code	Description
03-019-001	LARGE, 11½" (292 MM) LENGTH, 5¼" (146 MM) BLADE
03-019-002	SMALL, 8¾" (222 MM) LENGTH, 3¼" (83 MM) BLADE



Item Code	Description
03-020-001	BREAST ELEVATOR FOR MAMMARY PLASTY



FRONTOTEMPORAL DISSECTOR

Item Code	Description
03-021-001	9" (22.5 CM), 5MM TIP, SLIGHTLY CURVED
03-021-002	9" (23 CM), 7MM TIP, SLIGHTLY CURVED
03-021-003	9" (23 CM), 10MM TIP, SLIGHTLY CURVED



FLAP DISSECTOR

Item Code	Description
03-022-001	9½" (23.5 CM), 5MM TIP, STRAIGHT



TEMPORAL T DISSECTOR

Item Code	Description
03-023-001	9½" (23.5 CM), 12MM TIP, STRAIGHT



FRONTOGLABELLAR DISSECTOR

Item Code	Description
03-024-001	10½" (26.5 CM), 7MM TIP, S SHAPED

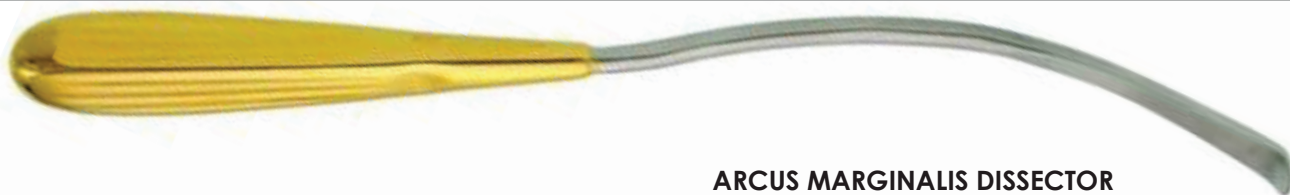

ARCUS MARGINALIS DISSECTOR

Item Code	Description
03-025-001	9 3/4" (24 CM), 10MM TIP, S SHAPED



MIDFACE FACIAL DISSECTOR,

Item Code Description

03-026-001 9¾" (24 CM), MULTIPLE CURVES,
12MM WIDE TIP



ORBITAL RIM DISSECTOR

Item Code Description

03-027-001 9" (22.5 CM), SLIGHTLY CURVED



TRANSORAL DISSECTOR

Item Code Description

03-028-001 9¾" (23.5 CM), CURVED TIP



ZYGOMATIC ARCH ELEVATOR

Item Code Description

03-029-001 8¼" (20.5 CM), STRAIGHT BLADE, 5MM



SCALP ELEVATOR

Item Code Description

03-030-001 9 3/4" (24 CM), 12.5MM TIP, SLIGHTLY CURVED

03-030-002 9 3/4" (24 CM), 15MM TIP, SLIGHTLY CURVED

03-030-003 9 3/4" (24 CM), 7MM TIP, STRAIGHT

03-030-004 9 3/4" (24 CM), 12.5MM TIP, S SHAPED

03-030-005 9 3/4" (24 CM), 12.5MM TIP, SLIGHTLY CURVED

03-030-006 9 3/4" (24 CM), 7MM TIP, CURVED TIP

03-030-007 9 3/4" (24 CM), 7MM TIP, STRONGLY CURVED

03-030-008 9 3/4" (24 CM), 7MM TIP, SLIGHTLY CURVED



SCALP ELEVATOR WITH SUCTION

Item Code	Description
03-031-001	9¾" (24 CM), 7MM WIDE TIP, SLIGHTLY CURVED



SCALP ELEVATOR WITH SUCTION

Item Code	Description
03-032-001	10½" (26 CM), 8.5 MM WIDE TIP, CURVED TIP



PERIOSTEAL ELEVATOR

03-033-001	10" (25 CM), S SHAPED
-------------------	-----------------------



PERIOSTEAL SPREADER

Item Code	Description
03-034-001	9¾" (24 CM), 8MM TIP, S SHAPED



PERIOSTEAL SPREADER

Item Code	Description
03-035-001	9¾" (24 CM), 10MM WIDE BLADE, S SHAPED



HALLE SEPTUM ELEVATOR

Item Code	Description
03-036-001	NARROW, 3 MM WIDTH, 7" (178 MM) LENGTH



FREER SEPTUM ELEVATOR

Item Code	Description
03-037-001	DOUBLE ENDED, SHARP / BLUNT, WIDE, 6.5 MM WIDTH, 7 ³ / ₄ " (197 MM) LENGTH



HAJEK BALLENGER SEPTUM ELEVATOR

Item Code	Description
03-038-001	DOUBLE ENDED, 8.5 MM WIDTH, 7 ¹ / ₂ " (191 MM) LENGTH



FREER SEPTUM ELEVATOR

Item Code	Description
03-039-001	CURVED, DOUBLE ENDED, 5 MM WIDTH, 7 ¹ / ₂ " (191 MM) LENGTH



KILLIAN SEPTUM ELEVATOR

Item Code	Description
03-040-001	DOUBLE ENDED, 4 MM WITH 3.4 MM TAPER, AND 4.3 MM WITH 3 MM TAPER, 7 ¹ / ₄ " (184 MM) LENGTH

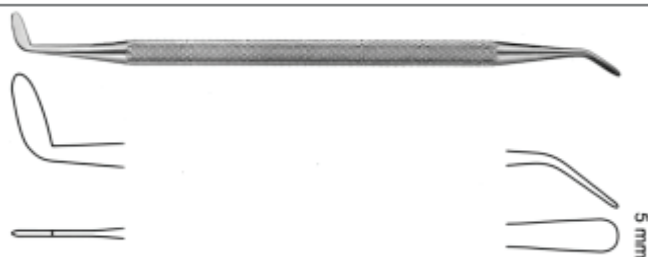

NAGATA AURICULAR SEPTUM

Item Code	Description
03-041-001	ELEVATOR, 16CM, BLUNT
03-041-002	ELEVATOR, 17CM, BLUNT

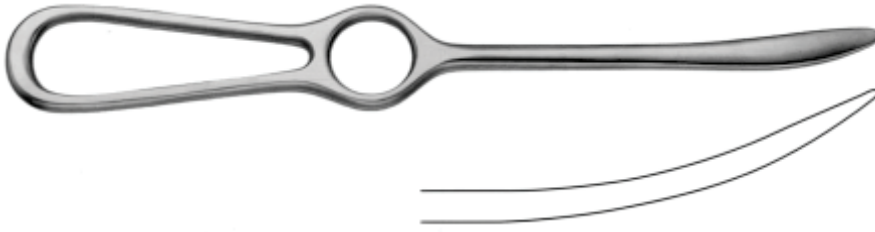

LANGENBECK BONE ELEVATOR

Item Code	Description
03-042-001	23CM, 10MM, BLUNT, STRONG CURVE



FREER PERIOSTEAL ELEVATOR

Item Code	Description
03-043-001	19CM, 5MM, DOUBLE ENDED, SHARP / BLUNT
03-043-002	19CM, 6.5MM, DOUBLE ENDED, SHARP / BLUNT

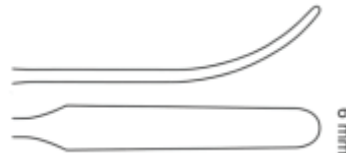

COHEN PERIOSTEAL ELEVATOR / RETRACTOR

Item Code	Description
03-044-001	24CM, 6MM, DOUBLE ENDED, BLUNT



PENNINGTON SEPTUM ELEVATOR

Item Code	Description
03-045-001	20CM, DOUBLE ENDED

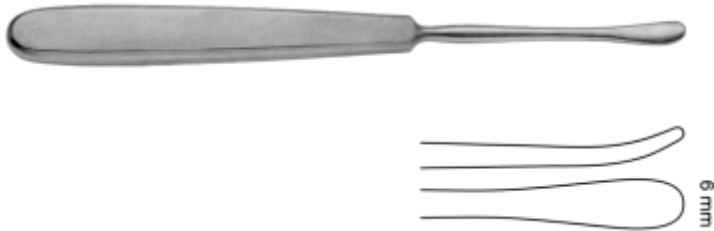

YANKAUER SEPTUM ELEVATOR

Item Code	Description
03-046-001	18CM, 6MM, BLUNT



COTTE PERIOSTEAL ELEVATOR

Item Code	Description
03-047-001	18CM, 8MM, BLUNT

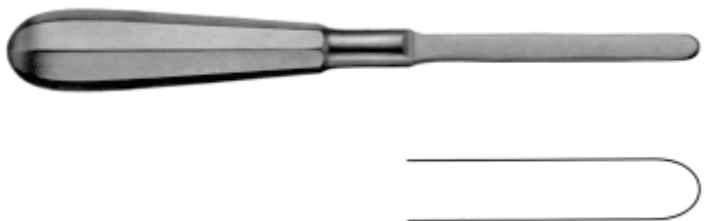

BOIES NASAL FRACTURE ELEVATOR

Item Code	Description
03-048-001	19CM, 8MM, BLUNT

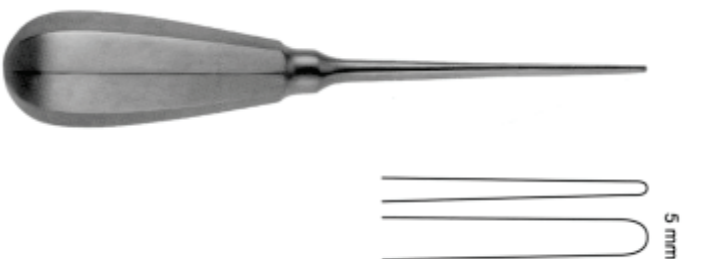

GOLDMAN SEPTUM FRACTURE ELEVATOR,

Item Code	Description
03-049-001	17CM, 5MM, BLUNT



NASAL FRACTURE ELEVATOR

Item Code	Description
03-050-001	17CM, 7MM, BLUNT



SUCTION ELEVATOR WITH GUIDE

Item Code	Description
03-051-001	21CM, 4MM

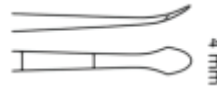
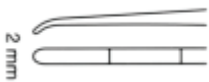

COTTLE PERIOSTEAL ELEVATOR

Item Code	Description
03-052-001	20CM, 2/4MM, DOUBLE ENDED, FINE
03-052-002	23CM, 3/4MM, DOUBLE ENDED

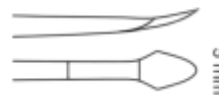

MASING SEPTUM ELEVATOR

Item Code	Description
03-053-001	22CM, 5/5MM, DOUBLE ENDED



LANGENBECK BONE ELEVATOR

Item Code	Description
03-054-001	20CM, 7MM, BLUNT
03-054-002	20CM, 10MM, BLUNT



HOWARTH SEPTUM ELEVATOR

Item Code Description

03-055-001 DOUBLE ENDED, 5 MM WIDTH, 8½"
(216 MM) LENGTH



KILLIAN SEPTUM ELEVATOR

Item Code Description

03-056-001 DOUBLE ENDED, 9" (229 MM) LENGTH,
6 MM WITH 4.5 MM TAPER AND 4.3 MM
WITH 3 MM TAPER



GRADUATED CHISELS

Item Code	Description
04-005-003	17.8CM, 3.8MM



GRADUATED CHISELS

Item Code	Description
04-005-004	17.8CM, 3.8MM



GRADUATED CHISELS

Item Code	Description
04-005-005	17.8CM, 7.5MM



GRADUATED CHISELS

Item Code	Description
04-005-006	17.8CM, 7.5MM



FREER SEPTUM CHISEL

Item Code	Description
04-001-001	15.5CM, 4MM
04-001-002	15.5CM, 6MM



BALLENGER SEPTUM CHISEL

Item Code	Description
04-002-001	16CM, 4MM
04-002-002	16CM, 6MM



KILLIAN NASAL GOUGE

Item Code	Description
04-003-001	17.5CM, 6MM



KILLIAN CLAUS NASAL GOUGE

Item Code	Description
04-004-001	17CM, 6MM



COTTLE GUBISCH CHISEL

Item Code Description

- 04-005-001** 18CM, 5MM, GRADUATED, HOLLOW CUT
- 04-005-002** 18CM, 12MM, GRADUATED, HOLLOW CUT



COTTLE CHISEL

Item Code Description

- 04-006-001** 18CM, 4MM, CROSS BAR, GRADUATED
- 04-006-002** 18CM, 7MM, CROSS BAR, GRADUATED
- 04-006-003** 18CM, 9MM, CROSS BAR, GRADUATED
- 04-006-004** 18CM, 12MM, CROSS BAR, GRADUATED

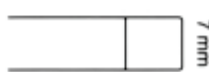
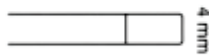
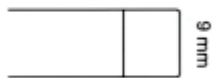

COTTLE CHISEL

Item Code Description

- 04-007-001** 18CM, 16MM, FISHTAIL SHAPED END, CROSSBAR,

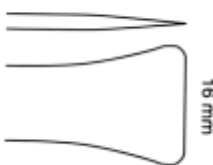

RUBIN EDGED BONE CHISEL

Item Code Description

- 04-008-001** 18CM, 8/12MM, T SHAPE
- 04-008-002** 18CM, 10/14MM, T SHAPE
- 04-008-003** 18CM, 12/16MM, T SHAPE

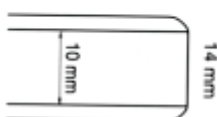
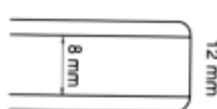
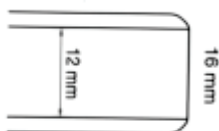

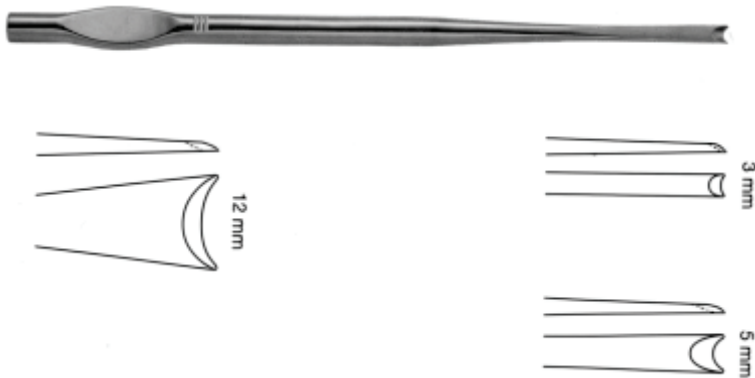

WALTER CHISEL/OSTEOTOME

Item Code	Description
04-009-001	19CM, 3MM, MODIFIED
04-009-002	19CM, 5MM, MODIFIED
04-009-003	19CM, 12MM, MODIFIED

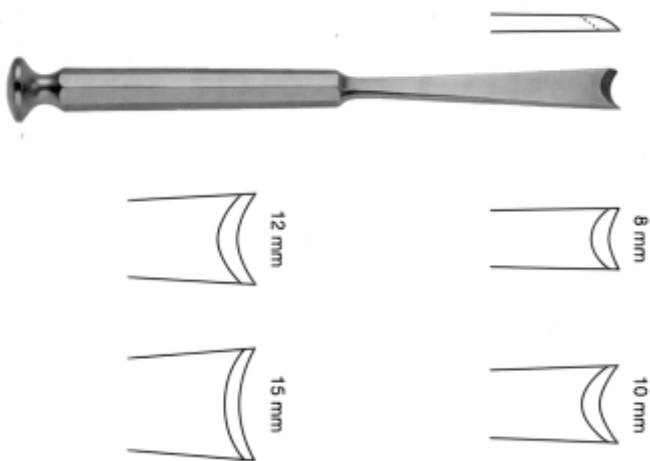

MCINDOE CHISEL

Item Code	Description
04-010-001	16CM, 8MM
04-010-002	16CM, 10MM
04-010-003	16CM, 12MM
04-010-004	16CM, 15MM

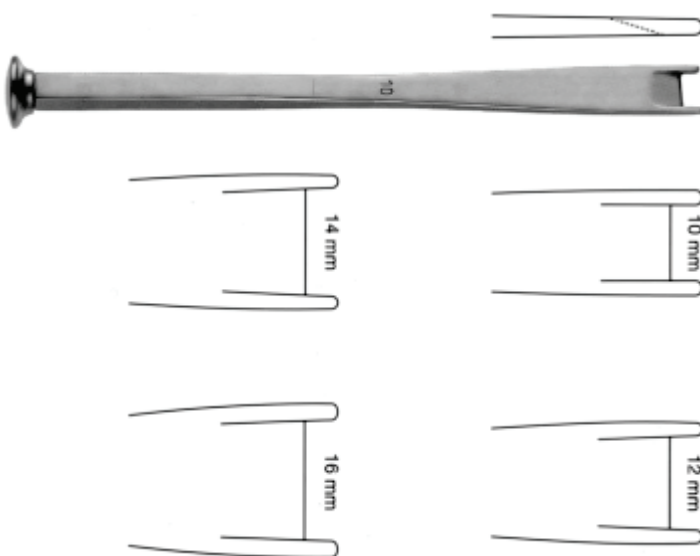

MOBERG CHISEL

Item Code	Description
04-011-001	18CM, 10MM
04-011-002	18CM, 12MM
04-011-003	18CM, 14MM
04-011-004	18CM, 16MM



BRAITHWAITE NASAL CHISEL

Item Code Description

04-011-001 RIGHT, 5 MM WIDTH, 5 1/2" (140 MM)

04-011-002 LEFT, 5 MM WIDTH, 5 1/2" (140 MM)



CLODIUS BONE CHISEL

Item Code Description

04-012-001 6 MM WIDTH, 8 3/4" (222 MM) LENGTH

8 MM WIDTH, 8 3/4" (222 MM) LENGTH

10 MM WIDTH, 8 3/4" (222 MM) LENGTH

20 MM WIDTH, 8 3/4" (222 MM) LENGTH



COTTLE OSTEOTOME, 18CM

Item Code Description

05-001-001	4MM, STRAIGHT, GRADUATED
05-001-002	7MM, STRAIGHT, GRADUATED
05-001-003	9MM, STRAIGHT, GRADUATED
05-001-004	12MM, STRAIGHT, GRADUATED



GUBISCH OSTEOTOME

Item Code Description

05-002-001	18.5CM, 3MM, ALUMINIUM HANDLE
-------------------	-------------------------------



COTTLE OSTEOTOME, 18CM

Item Code Description

05-003-001	16MM, FISHTAIL SHAPED END, STRAIGHT, GRADUATED
-------------------	--



RUBIN NASAL OSTEOTOME, 18CM

Item Code Description

05-004-001	10MM
05-004-002	14MM



COTTLE OSTEOTOME, 18CM

Item Code Description

05-005-001 6MM, CURVED, GRADUATED



COTTLE BONE LEVER/SPLITTING OSTEOTOME,

Item Code Description

05-006-001 20CM, 10MM



GUBISCH FANOUS NASAL OSTEOTOME

Item Code Description

05-007-001 19.5CM, NARROW, DELICATE,
WITH GUIDE THORN



FANOUS OSTEOTOME, 19.5CM

Item Code Description

05-008-001 4MM, STRAIGHT, WITH GUIDE THORN

05-008-002 4MM, LEFT, WITH GUIDE THORN

05-008-003 4MM, RIGHT, WITH GUIDE THORN

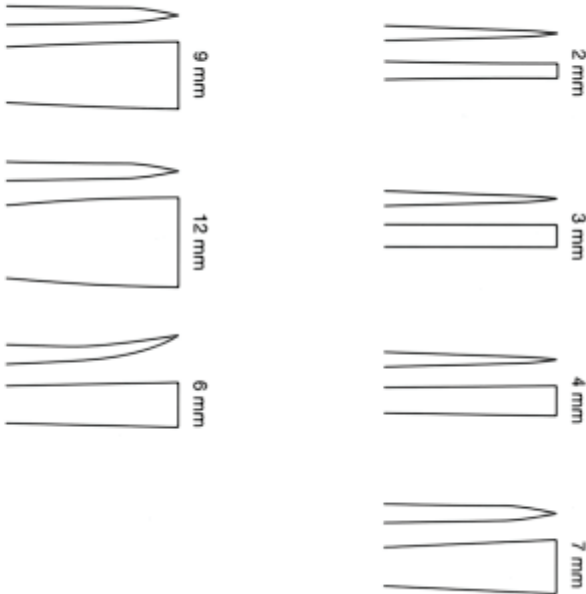

WALTER OSTEOTOME, 19CM

Item Code	Description
05-009-001	2MM
05-009-002	3MM
05-009-003	4MM
05-009-004	7MM
05-009-005	9MM,
05-009-006	12MM,
05-009-007	6MM, CURVED

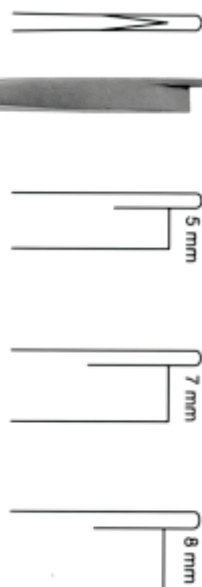

FOMON OSTEOTOME, 17CM

Item Code	Description
05-010-001	5MM, STRAIGHT
05-010-002	7MM, STRAIGHT
05-010-003	8MM, STRAIGHT

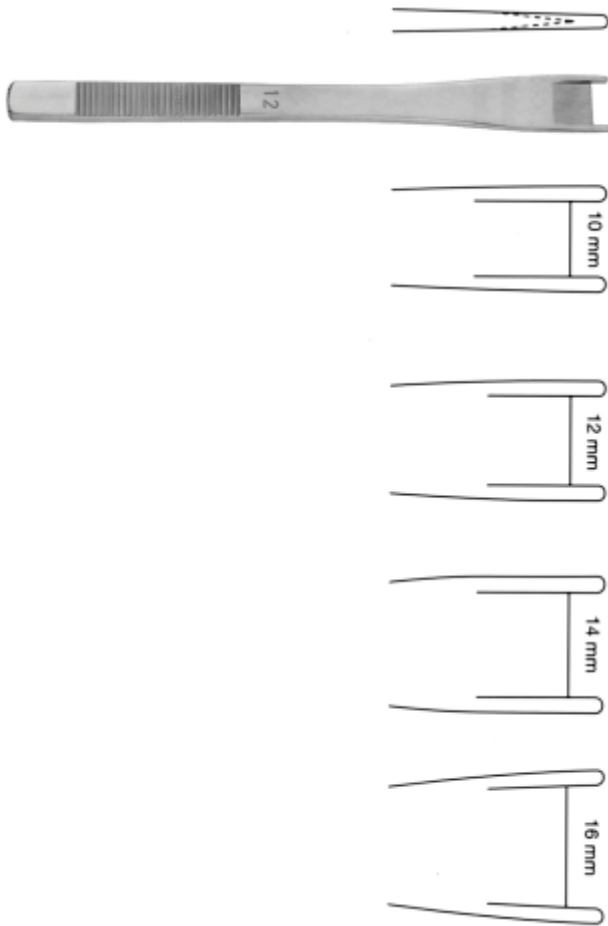

CINELLI GUARDED OSTEOTOME, 16CM

Item Code	Description
05-011-001	10MM, STRAIGHT
05-011-002	12MM, STRAIGHT
05-011-003	14MM, STRAIGHT
05-011-004	16MM, STRAIGHT



OBWEGESER PERIOSTEAL ELEVATOR / RASPATORY, 20CM

Item Code	Description
05-012-001	704MM, CURVED, SHARP
05-012-002	10X7MM, CURVED, SHARP
05-012-003	11X9MM, CURVED, SHARP

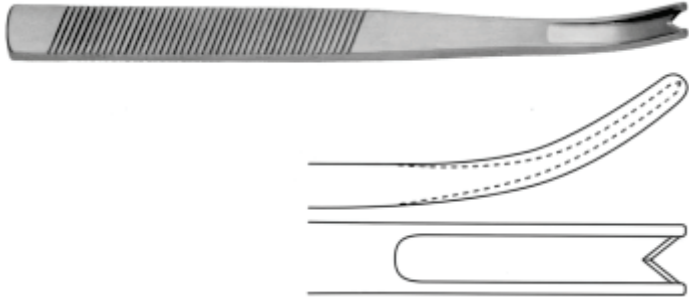

BLUME GUARDED OSTEOTOME, 18CM

Item Code	Description
05-013-001	6MM,CURVED, V SHAPED TIP

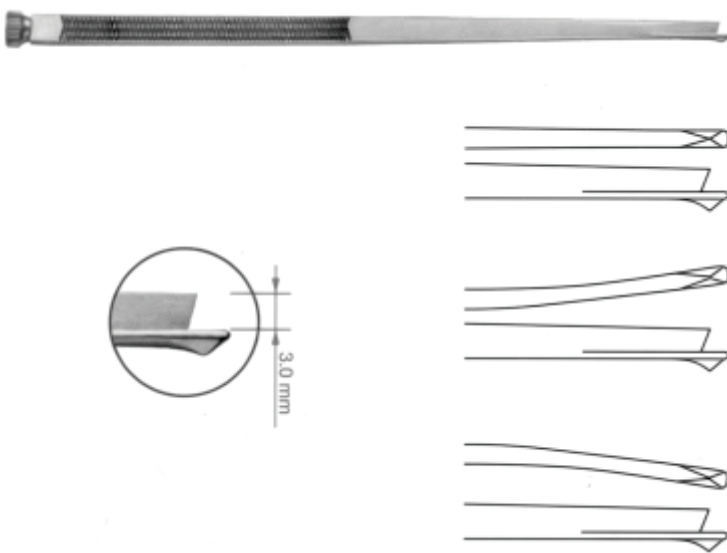

SCHROM OSTEOTOME, 19.5CM

Item Code	Description
05-014-001	3MM, STRAIGHT, WITH GUIDE THORN
05-014-002	3MM, RIGHT, WITH GUIDE THORN
05-014-003	3MM, LEFT, WITH GUIDE THORN

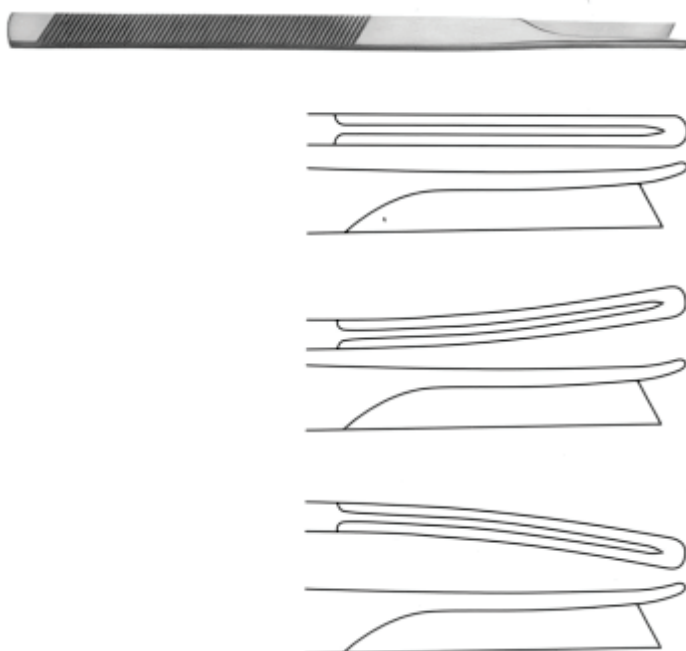

SILVER OSTEOTOME, 18CM

Item Code	Description
05-015-001	STRAIGHT
05-015-002	CURVED LEFT
05-015-003	CURVED RIGHT



OBWEGESER OSTEOTOME, 15CM

Item Code	Description
05-016-001	2.5MM
05-016-002	4.0MM



OBWEGESER SPLITTING OSTEOTOME, 21.5CM

Item Code	Description
05-017-001	7MM
05-017-002	10MM



OBWEGESER WEDGE OSTEOTOME, 22CM

Item Code	Description
05-018-001	8MM
05-018-002	12MM
05-018-003	16MM

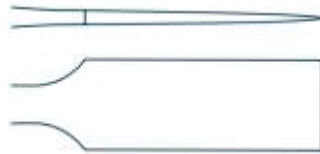

**OBWEGESER BLADE OSTEOTOME,
22CM**

Item Code	Description
05-019-001	8MM
05-019-002	12MM
05-019-003	16MM
05-019-004	20MM

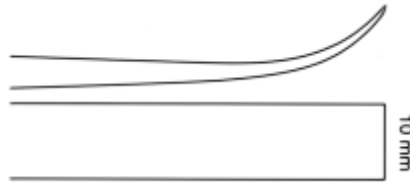

OBWEGESER PTERYGOID OSTEOTOME

Item Code	Description
05-020-001	23.5CM, 10MM, CURVED



**OBWEGESER FLEXIBLE OSTEOTOME,
21CM**

Item Code	Description
05-021-001	8MM, CURVED
05-021-002	10MM, CURVED



TESSIER OSTEOTOME, 20.5CM

Item Code	Description
05-022-001	10MM, STRAIGHT
05-022-002	10MM, CURVED
05-022-003	15MM, STRAIGHT
05-022-004	15MM, CURVED
05-022-005	20MM, STRAIGHT
05-022-006	30MM, STRAIGHT

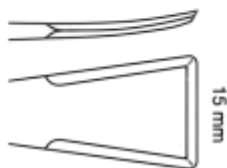
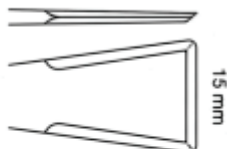

TESSIER OSTEOTOME, 16CM,

Item Code	Description
05-023-001	10MM, STRAIGHT, BEVELED EDGES
05-023-002	10MM, CURVED, BEVELED EDGES
05-023-003	15MM, STRAIGHT, BEVELED EDGES
05-023-004	16CM, 15MM, CURVED, BEVELED EDGES

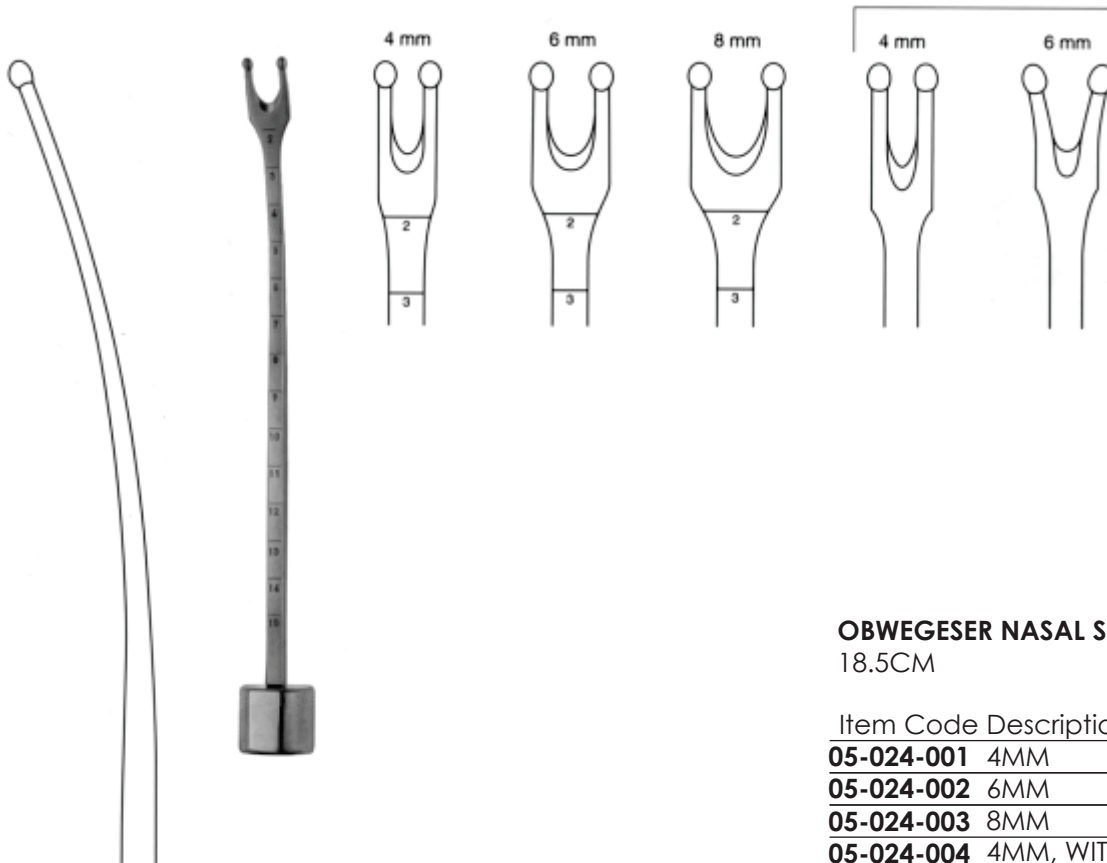

OBWEGESER NASAL SEPTUM OSTEOTOME,
18.5CM

Item Code	Description
05-024-001	4MM
05-024-002	6MM
05-024-003	8MM
05-024-004	4MM, WITHOUT SCALE

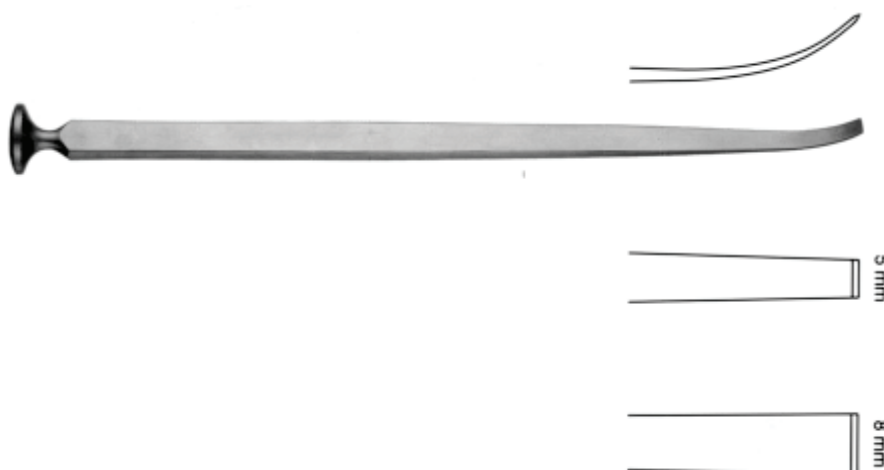

STEINHAUSER ORBITAL OSTEOTOME,
22.5CM,

Item Code	Description
05-025-001	5MM, CURVED
05-025-002	8MM, CURVED



ROZNER NASAL OSTEOTOME, 6.5 MM

Item Code	Description
05-026-001	WIDTH, 6 1/2" (165 MM) LENGTH



GIUNTA OSTEOTOME

Item Code	Description
05-027-001	DOUBLE GUARDED, CURVED, 4 MM WIDTH, 7" (178 MM) LENGTH



LAMBOTTE OSTEOTOME, 5" (127 MM)

Item Code	Description
05-028-001	4 MM
05-028-002	6 MM
05-028-003	8 MM
05-028-004	10 MM
05-028-005	12 MM



FREER RASPATORY, 19CM

Item Code	Description
05-029-001	5/5MM, DOUBLE ENDED, SHARP / SHARP

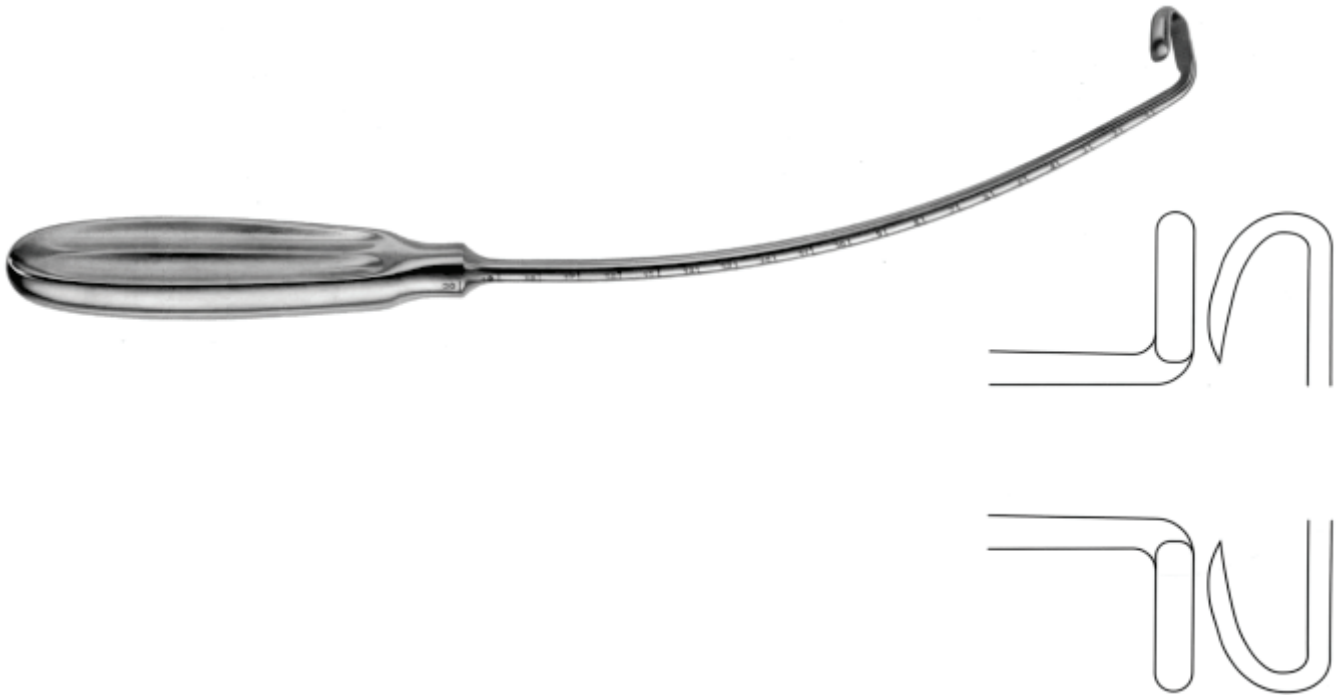

OBWEGESER RIB RASPATORY, 30CM

Item Code Description

05-030-001 LEFT

05-030-002 RIGHT

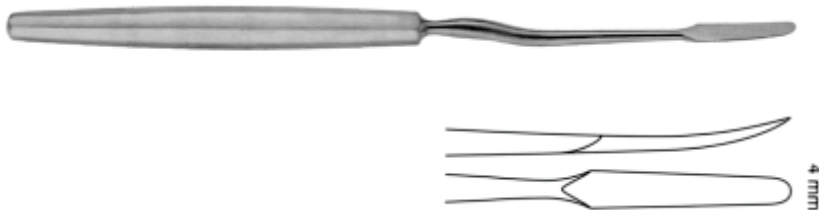

JOSEPH MASING SEPTUM RASPATORY

Item Code Description

05-031-001 22CM, 4MM, SHARP



COTTLE PERIOSTEAL ELEVATOR/RASPATORY

Item Code Description

05-032-001 18CM, 8MM, SHARP



**CONVERSE PERIOSTEAL ELEVATOR/
RASPATORY, 18CM**

Item Code Description
05-033-001 5MM, SHARP

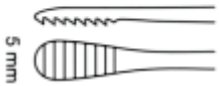

**COTTLE PERIOSTEUM COMB
AND RASPATORY, 23CM**

Item Code Description
05-034-001 1.5/5MM, DOUBLE ENDED



COTTLE MCKENTY RASPATORY, 22CM

Item Code Description
05-035-001 4/4MM, DOUBLE ENDED, SHARP



**OBWEGESER PERIOSTEAL ELEVATOR /
RASPATORY, 17.5CM**

Item Code Description
05-036-001 6MM, SHARP
05-036-002 7MM, SHARP
05-036-003 9MM, SHARP
05-036-004 11MM, SHARP

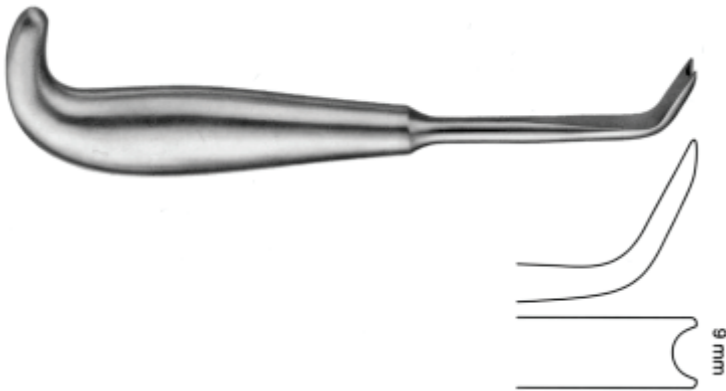

HARGIS RASPATORY, 19CM

Item Code	Description
05-037-001	9MM, ANGLED

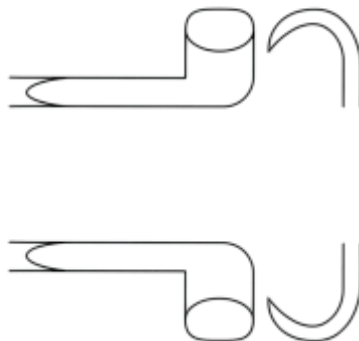

OBWEGESER MANDIBULAR RIM STRIPPER

Item Code	Description
05-038-001	19CM



OBWEGESER PERIOSTEAL ELEVATOR / RASPATORY, 17.5CM

Item Code	Description
05-039-001	9MM, V NOTCH

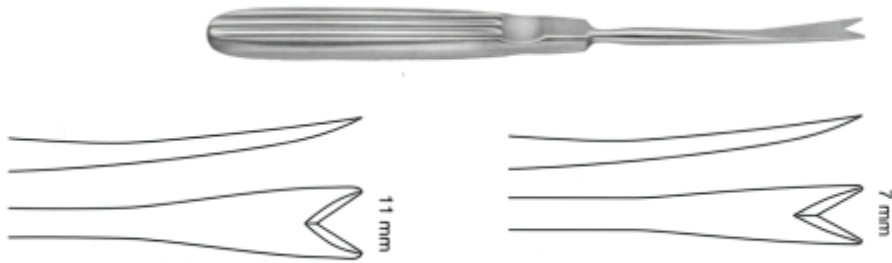

OBWEGESER SWALLOWTAIL STRIPPER, 17.5CM,

Item Code	Description
05-040-001	7MM
05-040-002	11MM

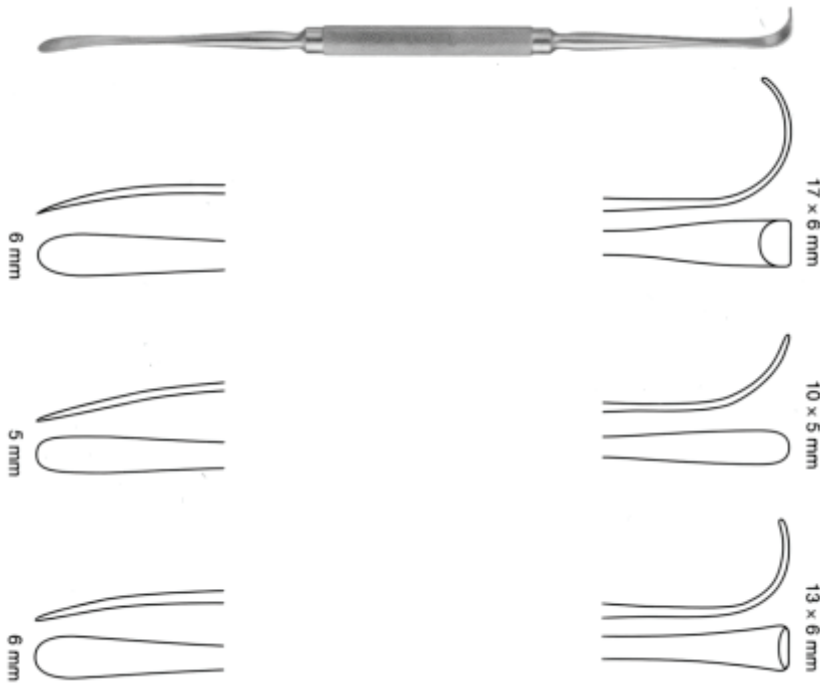

OBWEGESER FREER PERIOSTEAL ELEVATOR, 21CM,

Item Code	Description
05-041-001	6MM SHARP / 1705MM BLUNT
05-041-002	5MM SHARP / 10X5MM BLUNT
05-041-003	6MM SHARP / 1305MM BLUNT

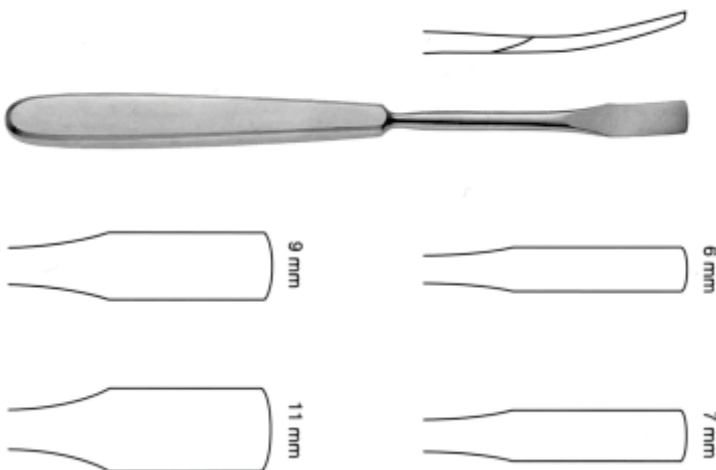

OBWEGESER PERIOSTEAL ELEVATOR, 18CM

Item Code	Description
05-042-001	6MM, BEVELED EDGE
05-042-002	7MM, BEVELED EDGE
05-042-003	9MM, BEVELED EDGE
05-042-004	11MM, BEVELED EDGE

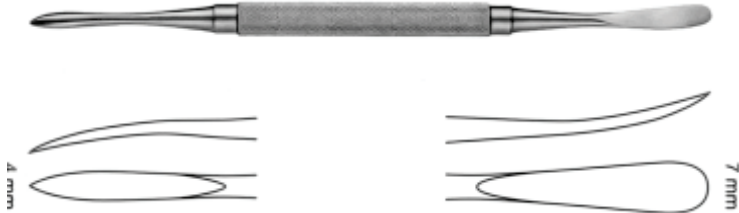

DINGMAN PERIOSTEAL ELEVATOR / RASPATORY, 18CM

Item Code	Description
05-043-001	4/7MM, SHARP / BLUNT



TESSIER RASPATORY, 18CM,

Item Code	Description
05-044-001	8MM, 30 DEGREE CURVED
05-044-002	12MM, 60 DEGREE CURVED



Item Code	Description
05-045-001	STEINHAUSER ORBITAL FLOOR RASPATORY, 17CM, 9X4MM

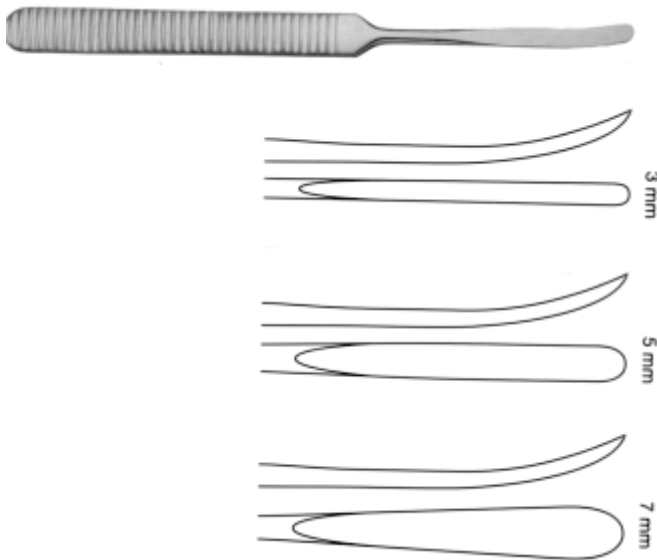

WILLIGER RASPATORY, 16CM

Item Code	Description
06-001-001	3MM, SHARP
06-001-002	5MM, SHARP
06-001-003	7MM, SHARP

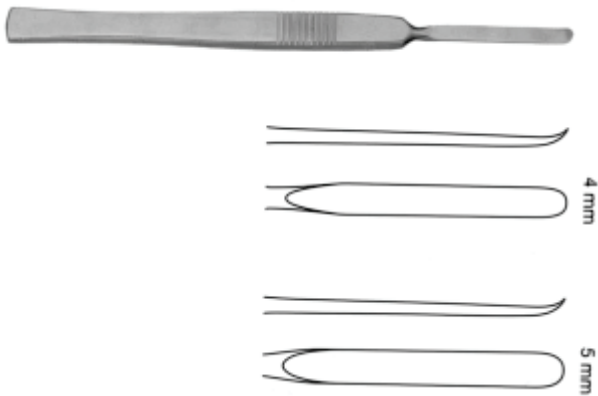

MCKENTY RASPATORY, 15CM

Item Code	Description
06-002-001	4MM, SHARP, LIGHT CURVE
06-002-002	5MM, SHARP, LIGHT CURVE



FREER MUCOSA END KNIFE

Item Code	Description
06-003-001	6" (15 CM)

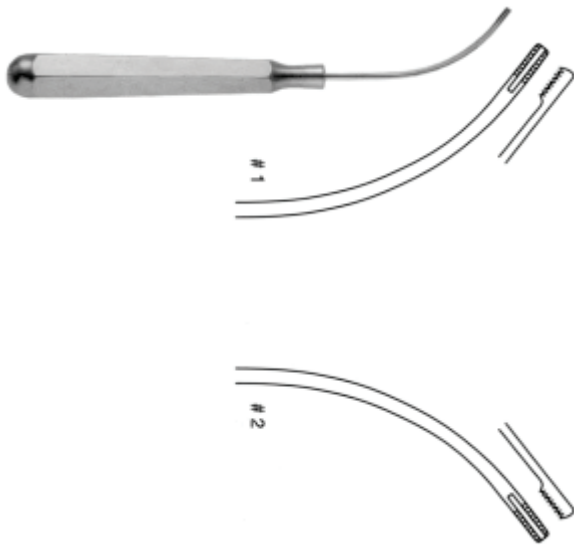

**DINGMAN CARTILAGE ABRADERS,
SET OF TWO**

Item Code	Description
07-001-001	#1, 15CM, CURVED LEFT
07-001-002	#2, 15CM, CURVED RIGHT

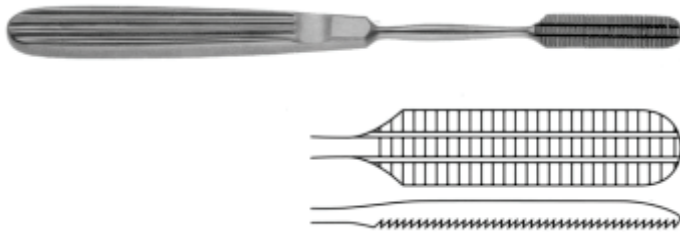

MALTZ NASAL RASP

Item Code	Description
07-002-001	18.5CM



LEWIS NASAL RASP

Item Code	Description
07-003-001	20CM

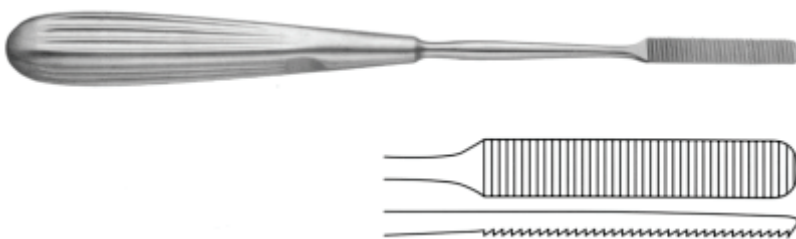

COTTLE NASAL RASP

Item Code	Description
07-004-001	21CM

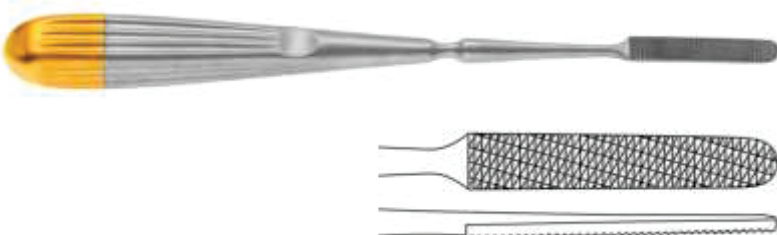

COTTLE T.C. NASAL RASP

Item Code	Description
07-005-001	20.5CM

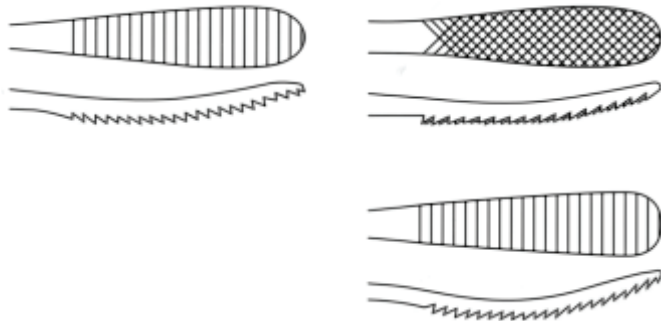

AUFRICHT NASAL RASP, 21CM

Item Code	Description
07-006-001	CROSS CUT
07-006-002	DOWN
07-006-003	UP

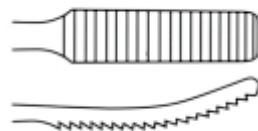

NASAL RASP

Item Code	Description
07-007-001	19.5CM, UP

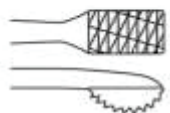

LEWIS T.C. NASAL RASP

Item Code	Description
07-008-001	19.5CM

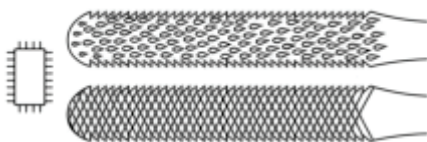

FOMON BONE AND NASAL RASP

Item Code	Description
07-009-001	20CM

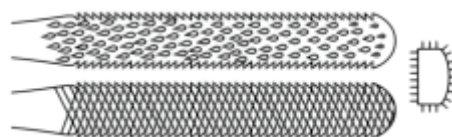

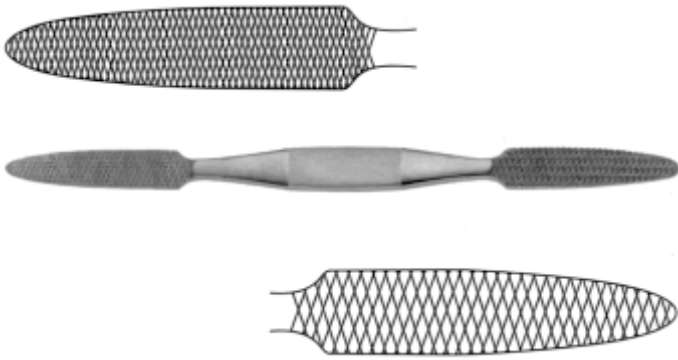

CONVERSE BONE AND NASAL FILE

Item Code	Description
07-010-001	18.5CM

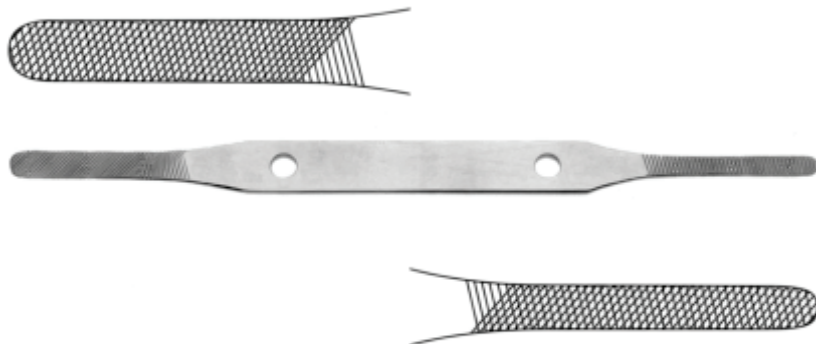

MASING NASAL FILE

Item Code	Description
07-011-001	21CM, FINE

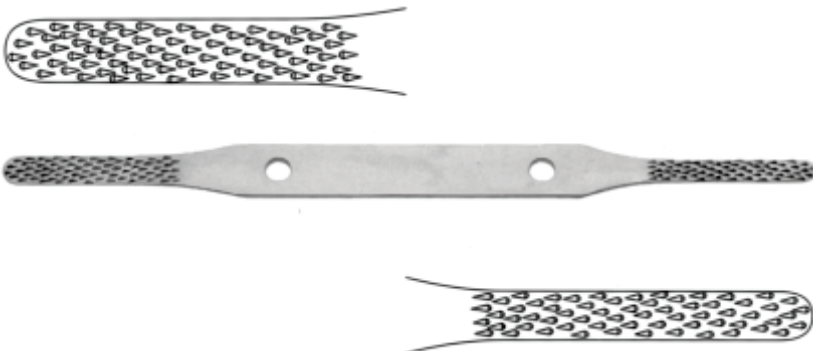

MASING NASAL RASP

Item Code	Description
07-012-001	21CM, COARSE

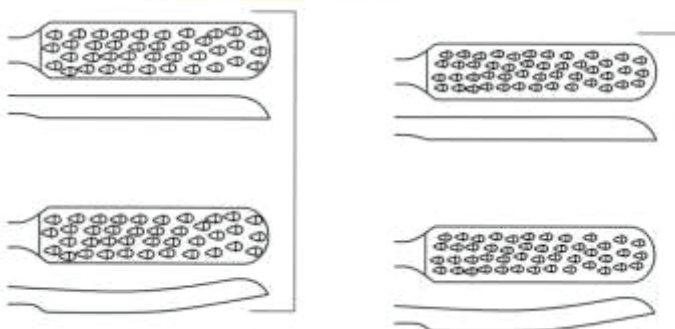

OBWEGESER NASAL RASP, 19.5CM

Item Code	Description
07-013-001	FLAT, FINE, DELICATE PATTERN
07-013-002	FLAT, MEDIUM FINE
07-013-003	CONVEX, FINE, DELICATE PATTERN
07-013-004	CONVEX, MEDIUM FINE

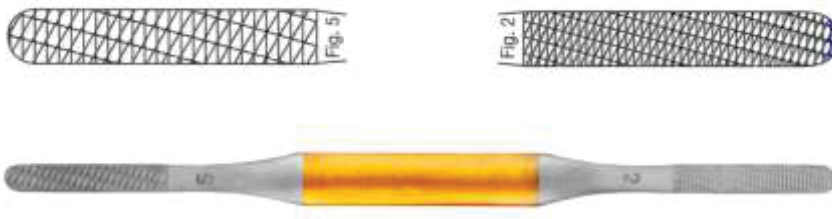

**GUBISCH FOMON T.C. NASAL RASP,
20CM**



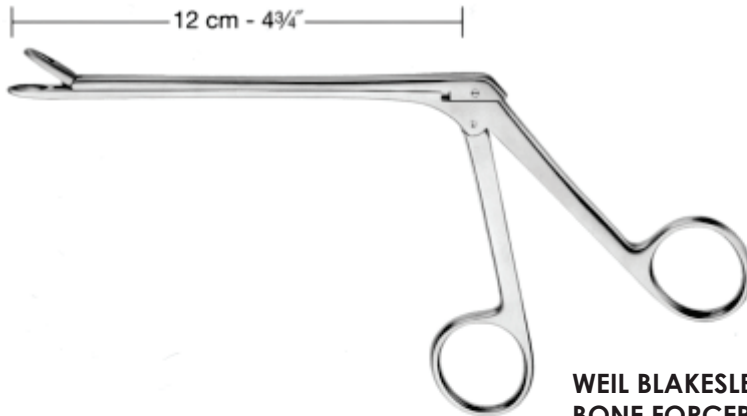

Item Code	Description
07-014-001	#1 and #2
07-014-002	#3 and #4
07-014-003	#5 and #6
07-014-004	#7 and #8
07-014-005	#9 and #10



**WEIL BLAKESLEY WILDE ETHMOID
BONE FORCEP**

NORMAL SHAFT



3,0 mm		08-001-001.	08-001-006	08-001-010
3,6 mm		08-001-002	08-001-007	08-001-011
4,2 mm		08-001-003	08-001-008	08-001-012
4,8 mm		08-001-004	08-001-009	08-001-013
5,6 mm		08-001-005		

SLIM SHAFT



3,0 mm		08-002-001	08-002-006
3,6 mm		08-002-002	08-002-007
4,2 mm		08-002-003	08-002-008
4,8 mm		08-002-004	08-002-009
5,6 mm		08-002-005	

11,5 cm - 4½"



**WEIL BLAKESLEY FORCEPS,
THROUGH CUT**

45°



2,0 mm 

08-003-001

08-003-004

2,5 mm 

08-003-002

08-003-005

3,0 mm 

08-003-003

08-003-006



COTTLE DOUBLE HOOK, 15CM

Item Code	Description
09-001-001	SHARP, 3X4MM

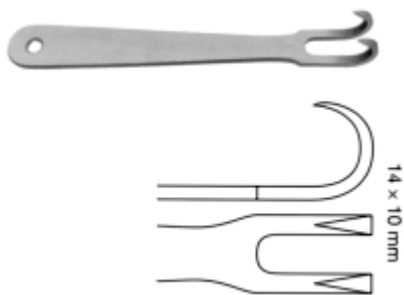

KILNER DOUBLE NASAL HOOK, 10CM

Item Code	Description
09-002-001	SHARP, 1409MM

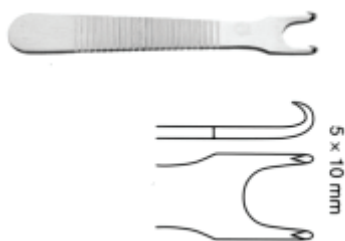

GUBISCH KILNER DOUBLE NASAL HOOK (ALAR RETRACTOR)

Item Code	Description
09-003-001	8CM, SHARP, 5090 MM

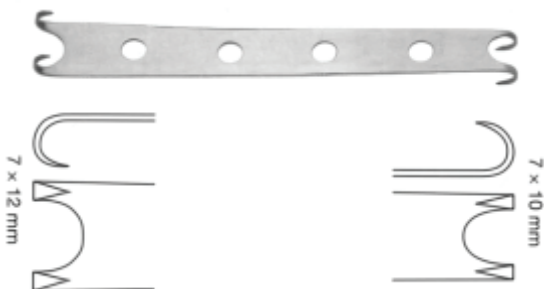

CONVERSE ALAR RETRACTOR, 12CM

Item Code	Description
09-004-001	DOUBLE ENDED, 709MM AND 7X14MM

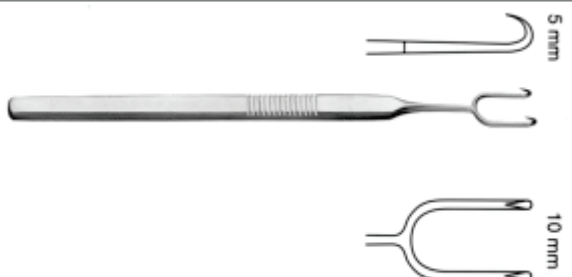

COTTLE ALAR AND SKIN HOOK, 14CM

Item Code	Description
09-005-001	2 PRONGS, SHARP, 509MM



MILLARD COTTELE RETRACTOR



Item Code	Description
09-006-001	WITH FINGER RING, 5.5CM, DOUBLE PRONG, SHARP, 5X12MM

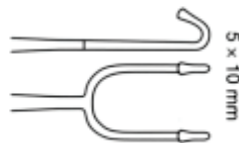

FOMON RETRACTOR, 17CM

Item Code	Description
09-007-001	BALL TIPS, 5 X 10 MM



COTTELE RETRACTOR, 15CM

Item Code	Description
09-008-001	4 PRONGS, BLUNT, 10090 MM

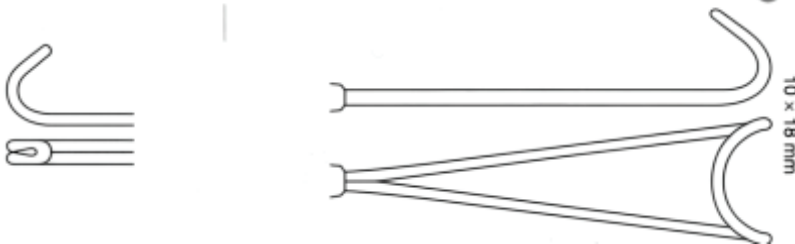

MASING RETRACTOR, 20CM

Item Code	Description
09-009-001	WITH GUIDE CHANNEL, 10X18MM



NEIVERT RETRACTOR, 19CM

Item Code	Description
09-010-001	DOUBLE ENDED, WITH GUIDE CHANNEL, 509MM



COTTLE NEIVERT RETRACTOR, 21CM

Item Code	Description
09-011-001	DOUBLE ENDED, 5090MM



COTTLE ALAR RETRACTOR, 14CM,

Item Code	Description
09-012-001	13X12MM

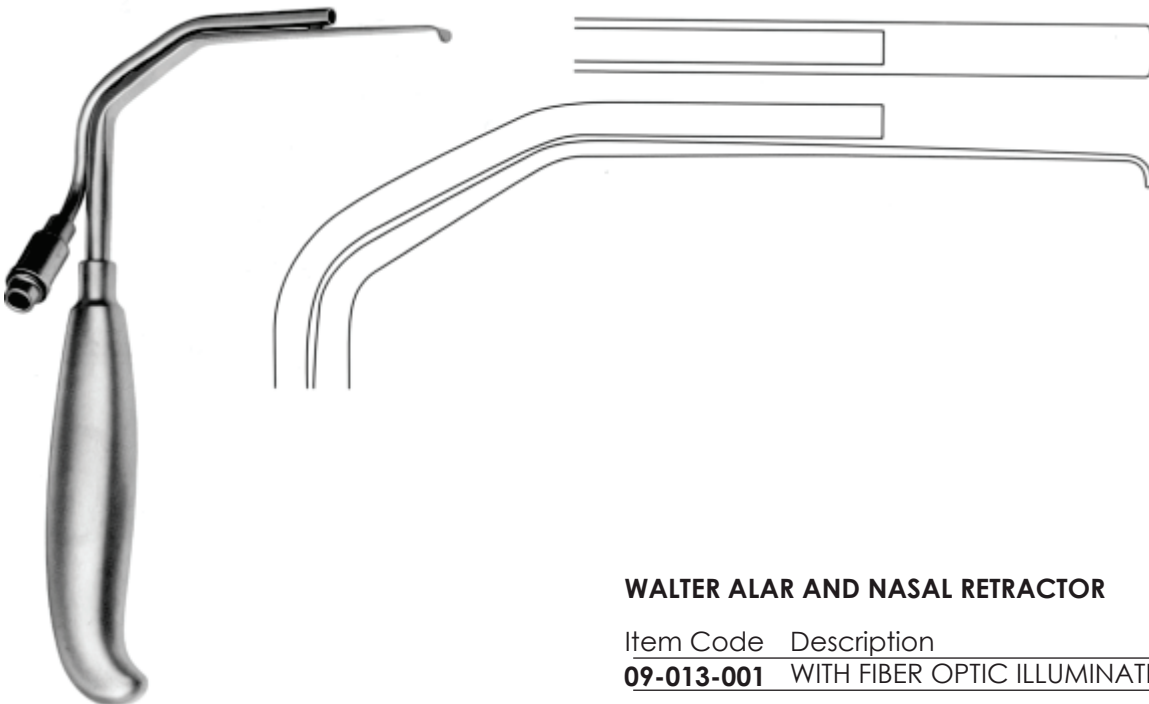

WALTER ALAR AND NASAL RETRACTOR

Item Code	Description
09-013-001	WITH FIBER OPTIC ILLUMINATION, 18.5CM

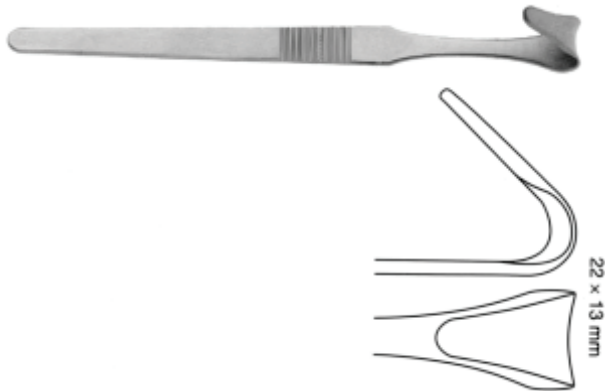

COTTLE ALAR RETRACTOR, 15CM

Item Code	Description
09-014-001	22X13MM

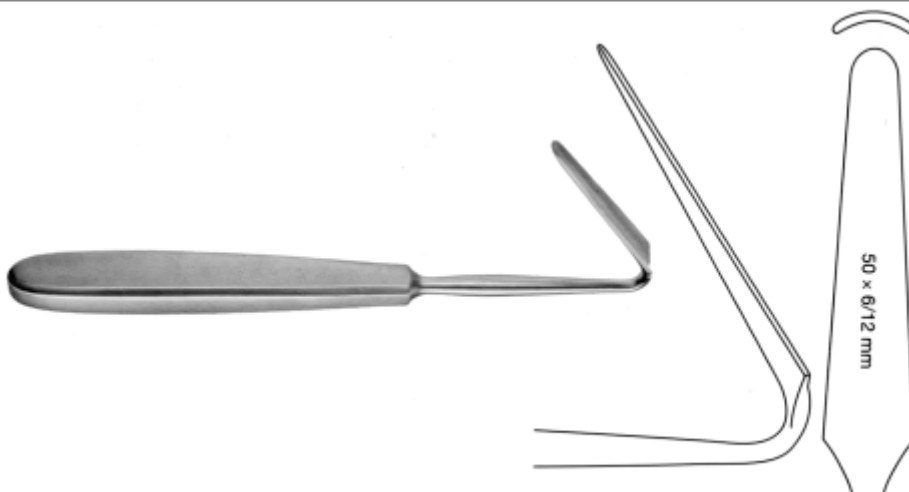

GUBISCH AUFRICHT NASAL RETRACTOR, 17CM

Item Code	Description
09-015-001	50X6-12MM

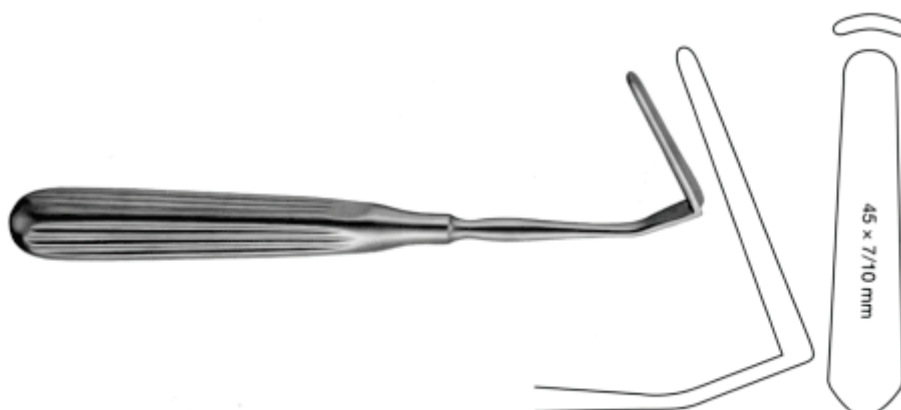

AUFRICHT NASAL RETRACTOR, 18CM

Item Code	Description
09-016-001	45X7-10MM

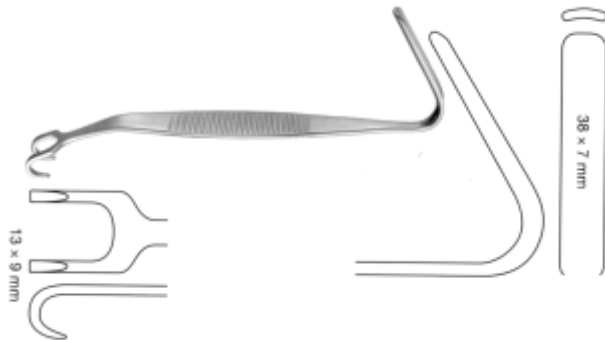

AUFRICT NASAL RETRACTOR, 13.5CM

Item Code	Description
09-017-001	DOUBLE ENDED, BLUNT, 38X7MM

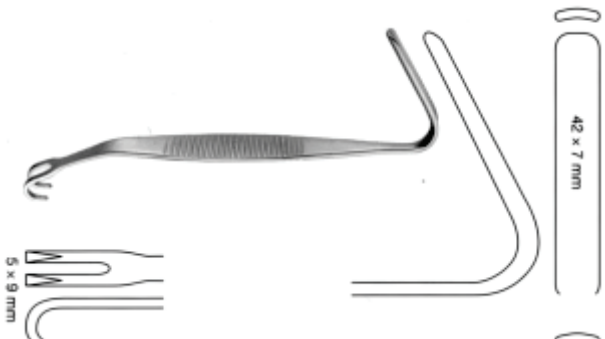

AUFRICT WALTER NASAL RETRACTOR

Item Code	Description
09-018-001	13.5CM, DOUBLE ENDED, BLUNT, 38X7MM

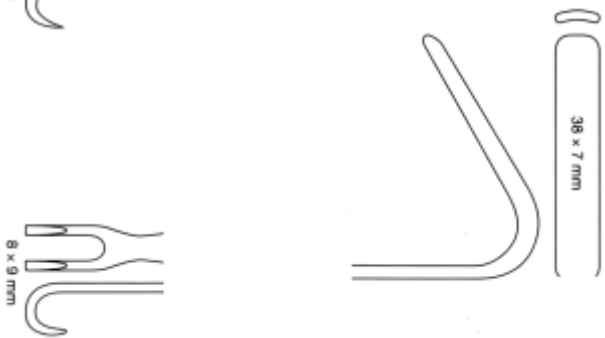

Item Code	Description
09-018-002	13.5CM, DOUBLE ENDED, SHARP, 42X7MM

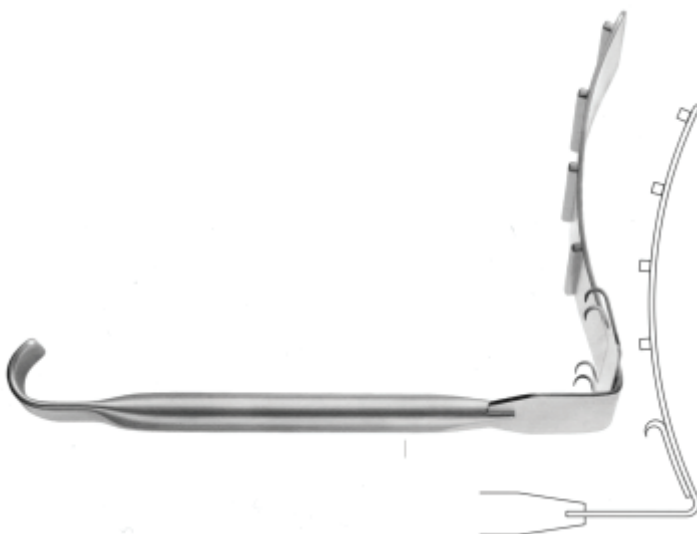

SALDANHA RETRACTOR

Item Code	Description
09-019-001	9 1/4" (23.5cm)



AUFRICHT NASAL RETRACTOR

Item Code	Description
09-020-001	6 1/4" (16CM), 7MM TIP, 45MM BLADE, WITH FIBER OPTIC LIGHT GUIDE
09-020-002	7" (18CM), 10MM TIP, 45MM BLADE, WITH FIBER OPTIC LIGHT GUIDE



**CONVERSE BLADE NASAL RETRACTOR,
WITH FIBER OPTIC LIGHT GUIDE**

Item Code	Description
09-021-001	20MM X 10MM WIDE
09-021-002	30MM X 12MM WIDE
09-021-003	40MM X 12MM WIDE
09-021-004	50MM X 12MM WIDE,



FOMON NASAL RETRACTOR

Item Code	Description
09-022-001	1 BALL END PRONG, 6 1/4" (16 CM)
09-022-002	2 BALL END PRONGS, 6 1/4" (16 CM)



JOSEPH NASAL SAW

Item Code	Description
10-001-001	17CM, STRAIGHT

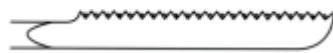

JOSEPH NASAL SAW, 17CM

Item Code	Description
10-002-001	LEFT
10-002-002	RIGHT

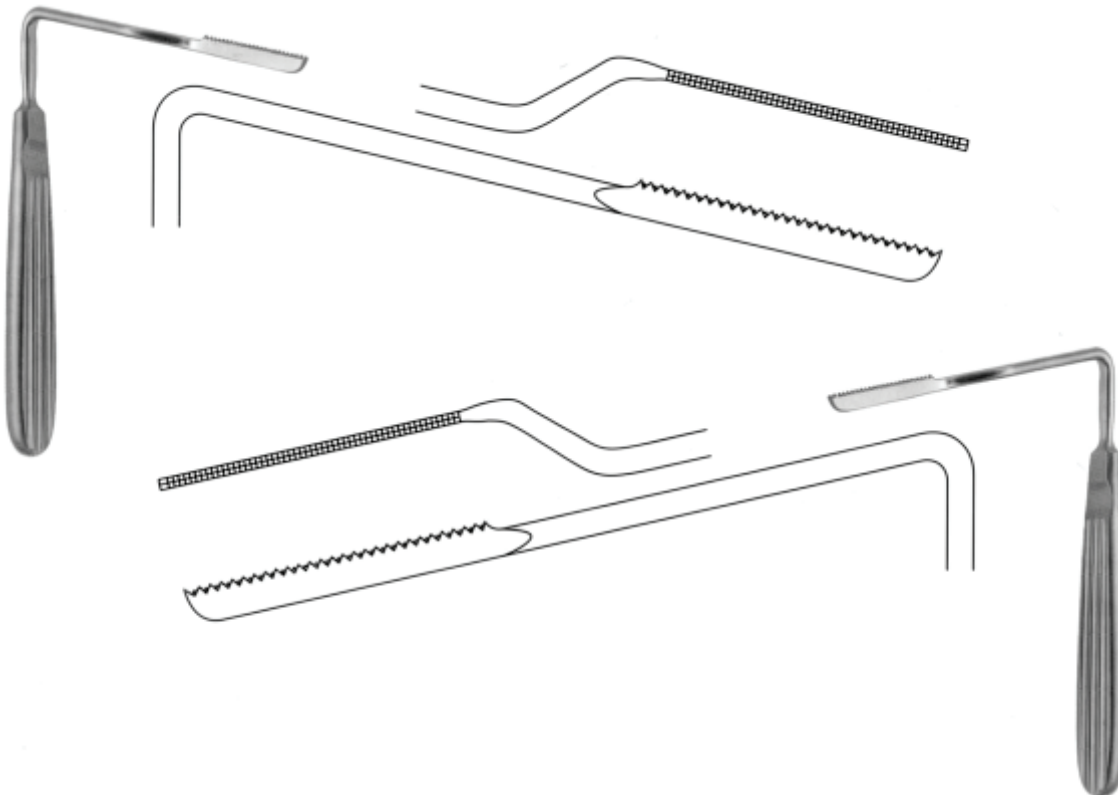

JOSEPH NASAL SAW

Item Code	Description
10-003-001	ANGLED TO LEFT
10-003-002	ANGLED TO RIGHT

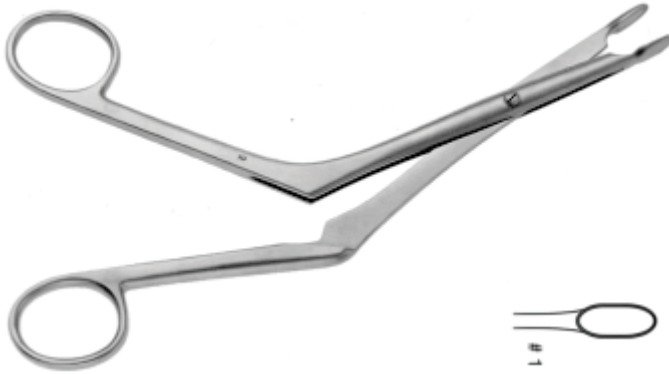

LUC BRUENINGS HEYMANN ETHMOID FORCEPS

Item Code	Description
11-001-001	18CM

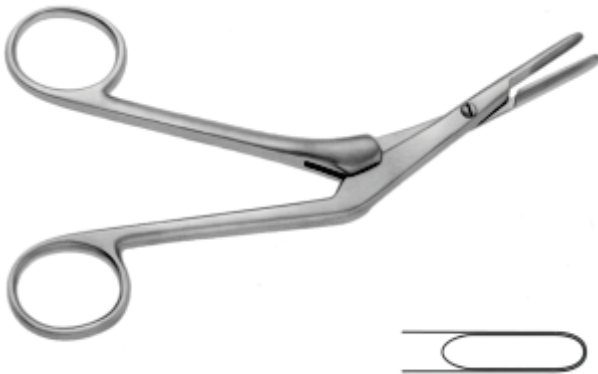

CRAIG VOMER FORCEPS

Item Code	Description
11-002-001	17CM



CRAIG DOMNICK SEPTUM FORCEPS, 17CM

Item Code	Description
11-003-001	CURVED RIGHT
11-003-002	CURVED LEFT



OBWEGESER NASAL SEPTUM CUTTER / PERFORATION FORCEPS

Item Code	Description
11-004-001	18.5CM



TIECK HALLE NASAL SPECULUM,
13.5CM

Item Code	Description
12-001-001	FOR BABIES
12-001-002	FOR INFANTS

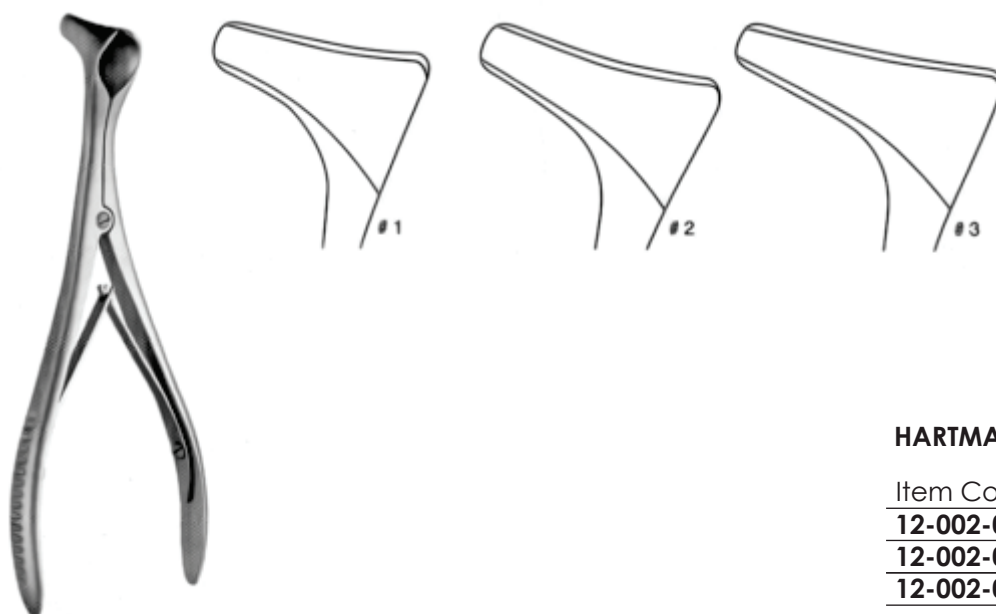

HARTMANN NASAL SPECULUM

Item Code	Description
12-002-001	#1, 15CM
12-002-002	#2, 15CM
12-002-003	#3, 15CM

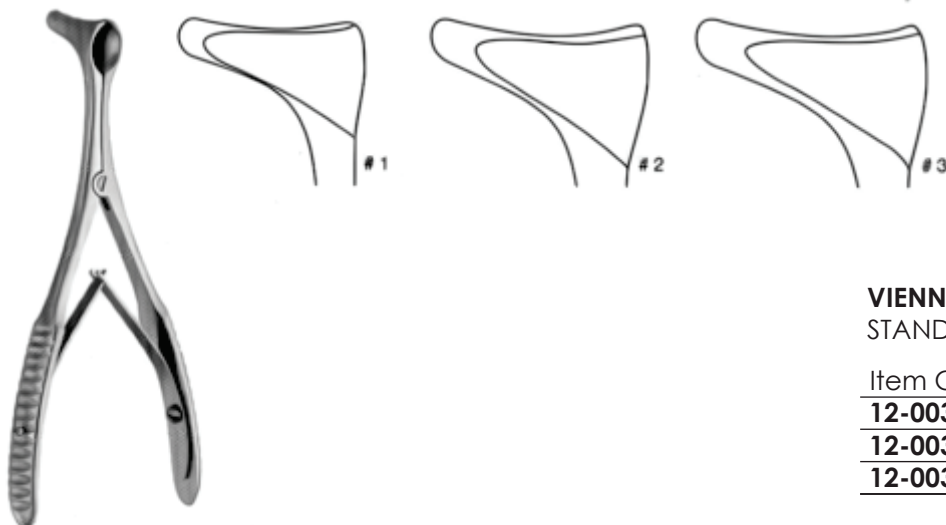

VIENNA MODEL (MODIFIED WIEN)
STANDARD NASAL SPECULUM

Item Code	Description
12-003-001	#1, 14CM
12-003-002	#2, 14CM
12-003-003	#3, 14CM



KILLIAN NASAL SPECULUM

Item Code	Description
12-004-001	#1, 14CM, 35MM
12-004-002	#2, 14CM, 50MM
12-004-003	#3, 14CM, 75MM
12-004-004	#4, 14CM, 90MM

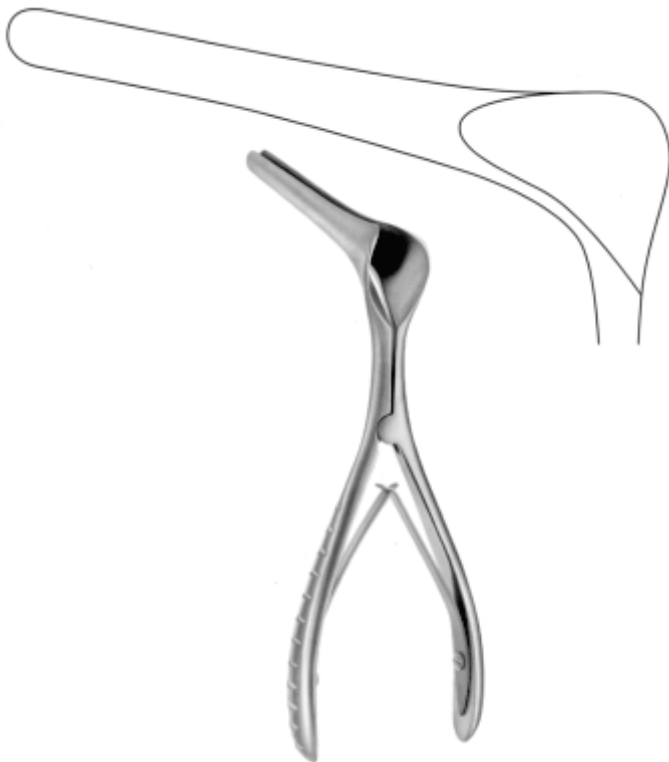

KILLIAN ASEPT NASAL SPECULUM

Item Code	Description
12-005-001	#4, 90MM (MODIFIED)



COTTLE NASAL SPECULUM

Item Code	Description
12-006-001	#1, 14CM, 35MM
12-006-002	#2, 14CM, 55MM
12-006-003	#3, 14CM, 75MM
12-006-004	#4, 14CM, 90MM



COTTLE NASAL SEPTUM SPECULUM

Item Code	Description
12-006-001	14CM, 50MM



COTTLE NASAL SPECULUM

Item Code	Description
12-007-001	DELICATE, 15CM, 55MM



COTTLE NASAL KNIFE

Item Code	Description
13-001-001	14CM, STRAIGHT



JOSEPH NASAL KNIFE

Item Code	Description
13-002-001	15CM, STRAIGHT, BUTTON END



CONVERSE RHINOPLASTY KNIFE

Item Code	Description
13-003-001	15CM, CURVED, BUTTON END



COTTLE DOUBLE EDGED KNIFE

Item Code	Description
13-004-001	15CM, STRAIGHT



JOSEPH DOUBLE EDGED KNIFE

Item Code	Description
13-005-001	15CM, CURVED, SHARP TIP



JOSEPH BUTTON END KNIFE

Item Code	Description
13-006-001	16CM, ANGLED

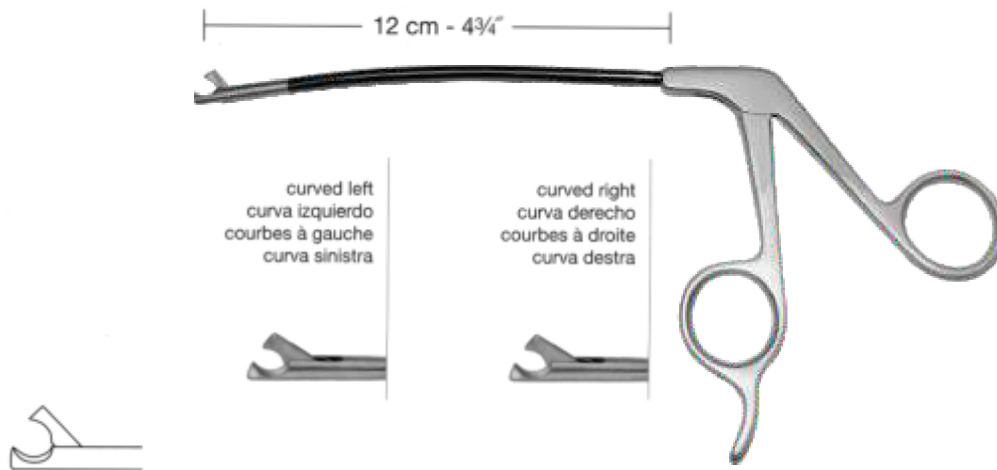

HOOK SCISSORS, 12cm SHAFT

Item Code	Description
14-001-001	LEFT
14-001-002	RIGHT

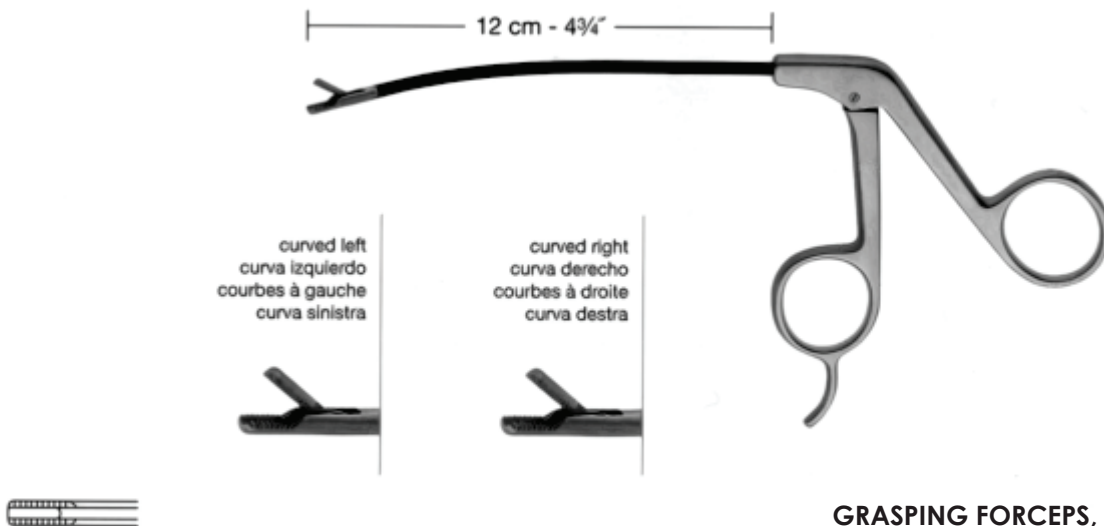

GRASPING FORCEPS, 12cm SHAFT

Item Code	Description
14-002-001	LEFT
14-002-002	RIGHT

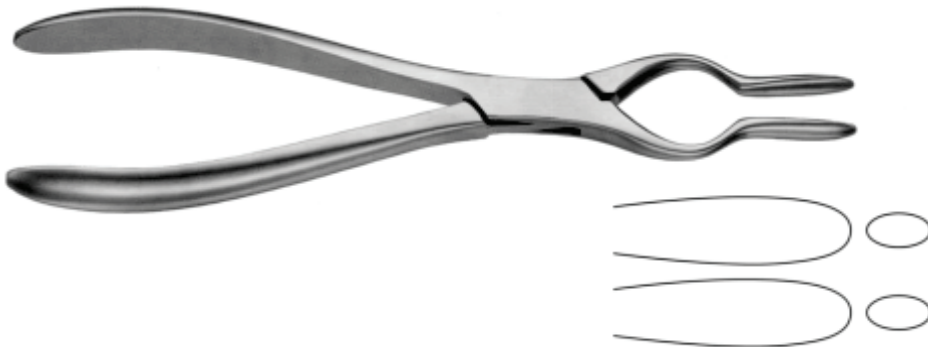

**WALSHAM UNIVERSAL
SEPTUM FORCEPS**

Item Code	Description
15-001-001	23CM

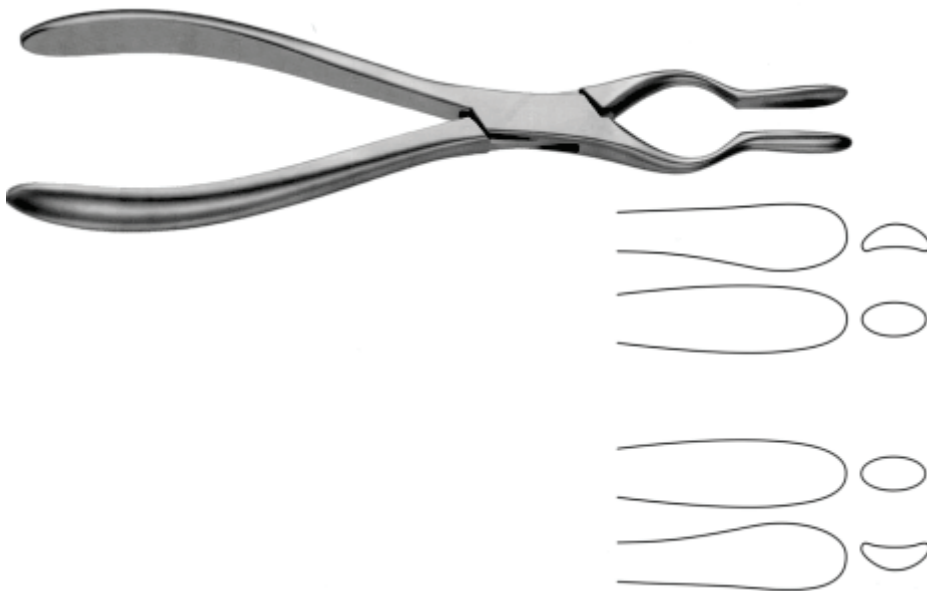

**WALSHAM SEPTUM STRAIGHTENING
FORCEPS, 23CM**

Item Code	Description
15-002-001	RIGHT
15-002-002	LEFT

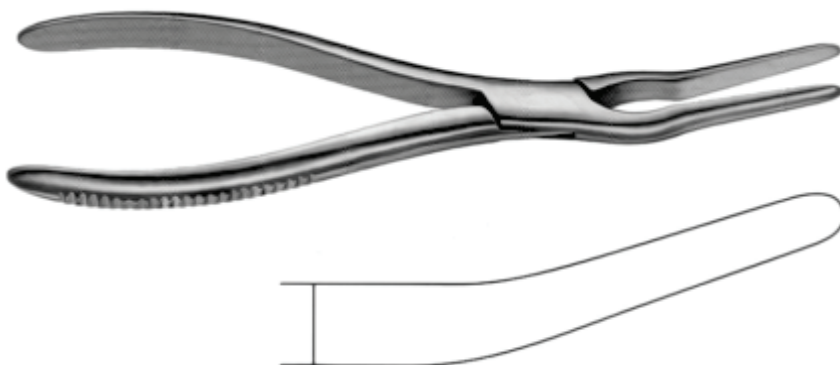

**ASCH SEPTUM STRAIGHTENING
FORCEPS**

Item Code	Description
15-003-001	22CM, ANGLED

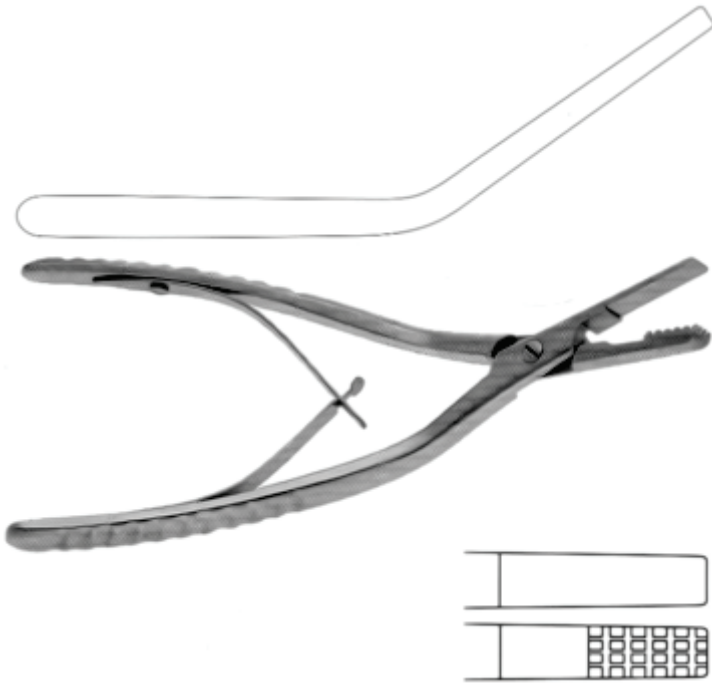

**OBWEGESER NASAL SEPTUM CUTTER /
PERFORATION FORCEPS**

Item Code	Description
15-004-001	18.5CM



MOLT MOUTH GAG

Item Code	Description
16-001-001	10CM, CHILD SIZE
16-001-002	5CM, ADULT SIZE



ROSER KOENIG MOUTH GAG

Item Code	Description
16-002-001	16CM



DENHART MOUTH GAG

Item Code	Description
16-003-001	13CM

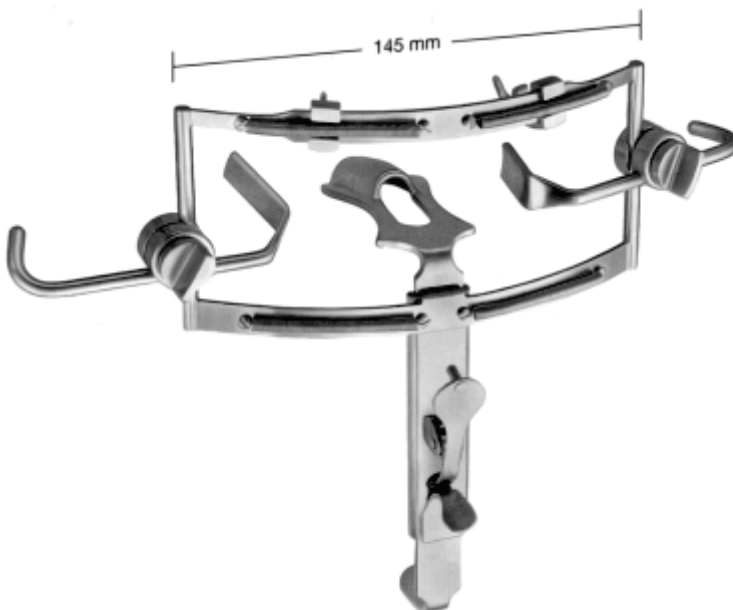

DINGMAN MOUTH GAG

Item Code	Description
16-004-001	COMPLETE

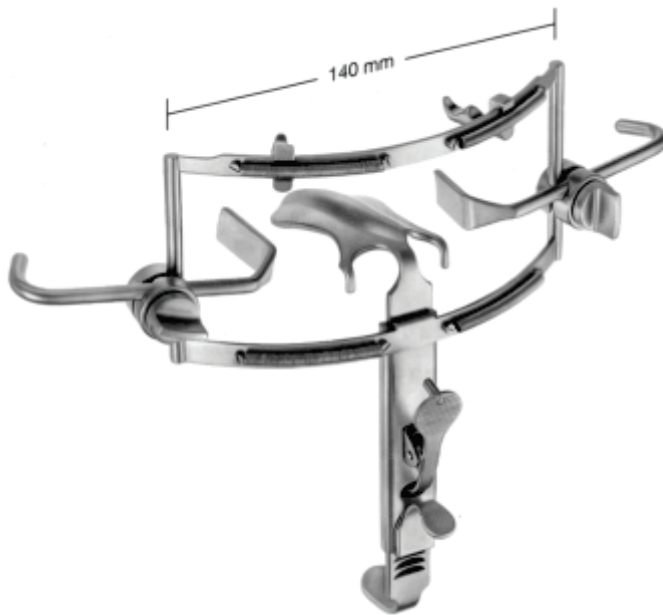

55 x 32 mm
Fig.1

Tongue depressor
Bajalengua
Abaisse-langue
Abbassalingua

60 x 35 mm
Fig.2

75 x 38 mm
Fig.3

WANG MOUTH GAG

Item Code	Description
16-005-001	COMPLETE



YANCOSKIE CORONAL LIFT RETRACTOR

Item Code	Description
17-001-001	OFFSET 8½" (216mm) WIDTH 150mm



YANCOSKIE ABDOMINOPLASTY RET.

Item Code	Description
17-002-001	OFFSET 7½" (190mm) WIDTH 150mm

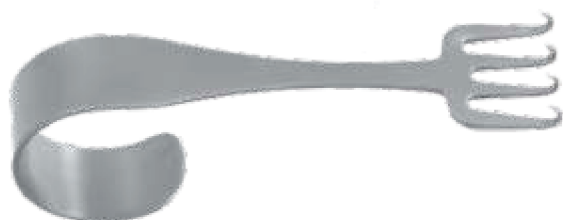

FREEMAN FACE LIFT RETRACTOR

Item Code	Description
17-003-001	SMALL FINGER RING, 4" (102mm) WIDTH 21.8mm
17-003-002	LARGE FINGER RING, 4¾" (121mm) WIDTH 25mm



FREEMAN FACE LIFT RETRACTOR

Item Code	Description
17-004-001	ADAMSON MODEL, 7" (178mm), 37mm



Item Code	Description
17-005-001	FREEMAN FLAP RAKE RETRACTOR 4 1/4" (108mm), 1 1/4" (32mm)



FREEMAN RAKE RETRACTOR

Item Code	Description
17-006-001	4" (100mm), WIDTH (22mm)
17-006-002	4" (100mm), WIDTH (38mm)



GORNEY RAKE RETRACTOR

Item Code	Description
17-007-001	3" (75mm), WIDTH (38mm)
17-007-002	4 1/4" (108mm), WIDTH (38mm)



FRAZIER HOOK

Item Code	Description
17-008-001	SHARP, 5" (127mm), 5mm
17-008-002	BLUNT, 5" (127mm), 5mm



TYRELL HOOK

Item Code	Description
17-009-001	SHARP, 5" (127mm), 2mm
17-009-002	BLUNT, 5" (127mm), 2mm



KILNER SKIN HOOK

Item Code	Description
17-010-001	SHARP, SMOOTH HANDLE, 5" (127mm), 2.5mm



GUTHRIE HOOK

Item Code	Description
17-011-001	SHARP, 4 ³ / ₄ " (121mm), 2.5mm



JOSEPH DOUBLE PRONG HOOK

Item Code	Description
17-012-001	SHARP, 6 ¹ / ₄ " (159mm) , 2mm
17-012-002	SHARP, 6 ¹ / ₄ " (159mm) , 5mm
17-012-003	SHARP, 6 ¹ / ₄ " (159mm) , 7mm
17-012-004	SHARP, 6 ¹ / ₄ " (159mm) , 10mm
17-012-005	SHARP, 6 ¹ / ₄ " (159mm) , 12mm



MAMMAPLASTY OR MASTECTOMY HOOK

Item Code	Description
17-013-001	EXTRA LARGE, SHARP, 7½" (191mm), 10mm



FREEMAN SKIN HOOK, 4" (102mm)

Item Code	Description
17-014-001	SINGLE SHARP HOOK, 5mm
17-014-002	DOUBLE SHARP HOOK, 5mm



CLODIUS FISH HOOK RETRACTOR

Item Code	Description
17-015-001	WITH CHAIN, SMALL, 7mm
17-015-002	WITH CHAIN, LARGE, 12mm



MILLARD THUMB SINGLE HOOK

Item Code	Description
17-016-001	STANDARD, 5mm



MILLARD THUMB DOUBLE HOOK

Item Code	Description
17-017-001	STANDARD, 17mm



FREEMAN FLAP RETRACTOR

Item Code	Description
17-018-001	8" (203mm) ½" (13mm)
17-018-002	8" (203mm) 1" (25mm)



FREEMAN FLAP RETRACTOR FIBER OPTIC

Item Code	Description
17-019-001	8" (203mm) ½" (13mm)
17-019-002	8" (203mm) 1" (25mm)



SWIVEL DOUBLE HOOK/RETRACTOR

Item Code	Description
17-020-001	2 SHARP PRONG WITH SWIVEL RING 3½" (89mm), 10mm



MARTINEZ-KILNER NASAL RETRACTOR

Item Code	Description
17-021-001	2 SHARP PRONGS WITH THUMB RING 4½" (114mm) 7.5mm



SHEEN NASAL RETRACTOR

Item Code	Description
17-022-001	ANGLED, 6½" (165mm), 10mm



SHEEN RETRACTOR

Item Code	Description
17-023-001	CURVED, 6¼" (159mm), 6.5mm



FARABEUFR RETRACTOR

Item Code	Description
17-024-001	STANDARD SET OF 2, 6" (152mm)



U.S. ARMY RETRACTOR, SET OF 2

Item Code	Description
17-025-001	8½" (216mm)



DEAVER RETRACTOR,

Item Code	Description
17-026-001	12" (305mm), 1" (25mm)



RIBBON RETRACTOR

Item Code	Description
17-027-001	INFANT, 6¾" (171mm), 5/8" (16mm)
17-027-002	PEDIATRIC, 8" (203mm), 5/8" (16mm)
17-027-003	PEDIATRIC, 8" (203mm), 1" (25mm)



MEYERDING FINGER RETRACTOR



Item Code	Description
17-028-001	STYLE 1, 7" (178mm), 18mmX7.5mm
17-028-002	STYLE 2, 7" (178mm), 16mmX5.5mm
17-028-003	STYLE 3, 7" (178mm), 8mmX4.5mm
17-028-004	STYLE 4, 7" (178mm), 10mmX3.5mm
17-028-005	STYLE 5, 7" (178mm), 8mmX4mm

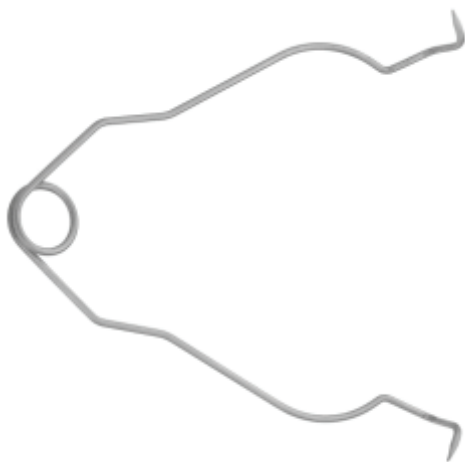

FARR STYLE SPRING RETRACTOR

Item Code	Description
17-029-001	SHARP POINTS, 1½" (38mm)
17-029-002	SHARP POINTS, 2" (51mm)
17-029-003	SHARP POINTS, 2¼" (57mm)
17-029-004	SHARP POINTS, 2½" (64mm)
17-029-005	SHARP POINTS, 3" (76mm)
17-029-006	SHARP POINTS, 2½" (64mm)



ALM SELF-RETRAINING RETRACTOR

Item Code	Description
17-030-001	4 X 4 BLUNT PRONGS, 2¾" (70mm)
17-030-002	4 X 4 SHARP PRONGS, 2¾" (70mm)
17-030-003	4 X 4 BLUNT PRONGS, 4" (102mm)



HOLZHEIMER CROSS-ACTION RETRACTOR

Item Code	Description
17-031-001	4 X 4 SHARP PRONGS, 4" (102mm)
17-031-002	4 X 4 BLUNT PRONGS, 4" (102mm)



PAPARELLA-WEITLANER RETRACTOR

Item Code	Description
17-032-001	2 X 2 SEMI-SHARP PRONGS 5" (127mm), 33mm INSIDE SPREAD

Cortical Cutter



SHEPARD CORTICAL CUTTER

Item Code	Description
18-001-001	12 cm/ 4 ³ / ₄ "

For turning cylinder osteotomes



SHEPARD FOR TURNING CYLINDER

Item Code	Description
18-002-001	11 cm/ 4 3/8"



CYLINDER OSTEOTOES, 12.5cm/5"



Item Code	Description
18-003-001	Ø5mm
18-003-002	Ø6mm
18-003-003	Ø8mm

RAM, 14cm/5¹/₂"



Item Code	Description
18-004-001	Ø5mm
18-004-002	Ø6mm
18-004-003	Ø8mm

TROCARS 14.5cm/5³/₄"



Item Code	Description
18-005-001	Ø5mm
18-005-002	Ø6mm
18-005-003	Ø8mm



UNIVERSAL T. C. WIRE CUTTING SCISSORS

Item Code	Description
19-001-001	12CM



NIRO T.C. WIRE TWISTING FORCEPS

Item Code	Description
19-002-001	15CM



NAGATA AURICULAR SEPTUM ELEVATOR

Item Code	Description
19-003-001	16CM, BLUNT
19-003-002	17CM, BLUNT



DOYEN RIB RASPATORY, 17CM

Item Code	Description
19-004-001	RIGHT
19-004-002	LEFT



KISTLER ANTHELIX CARTILAGE RASP

Item Code	Description
19-005-001	RIGHT
19-005-002	LEFT





MAYO SCISSORS

Item Code	Description
20-001-001	SUPERCUT PLUS T.C. (TUNGSTEN CARBIDE) 17CM, CURVED



COTTLE CARTILAGE CRUSHER

Item Code	Description
20-002-001	WITH CLAMP, FOR TAKING OUT THE PREPARED MATERIAL, 65X30X30MM



CARTILAGE CUTTING BLOCK

Item Code	Description
20-003-001	TEFLON, 85X55X10MM



GUBISCH CARTILAGE CRUSHER

Item Code	Description
20-004-001	65X30MM



AIACH FORCEPS

Item Code	Description
20-005-001	16CM, 5MM TIP



DINGMAN CARTILAGE ABRADERS

Item Code	Description
20-006-001	SET OF TWO



RUBIN SEPTAL MORSELIZER FORCEPS

Item Code	Description
20-007-001	21CM



RUBIN SEPTAL MORSELIZER FORCEPS

Item Code	Description
20-008-001	T.C. (TUNGSTEN CARBIDE) 20CM



BONE MILL

Item Code	Description
<u>20-009-001</u>	<u>WITH ASSEMBLING WRENCH</u>



HUMBY DERMATOME KNIFE, ADJUSTABLE

Item Code	Description
21-001-001	COMPLETE WITH WOODEN BOX, 32CM



Item Code	Description
21-002-001	SPARE BLADE FOR HUMBY AND WATSON DERMATOME



WATSON DERMATOME

Item Code	Description
21-003-001	(SKIN GRAFT KNIFE)



SCHINK DERMATOME

Item Code	Description
21-004-001	30CM, ADJUSTABLE

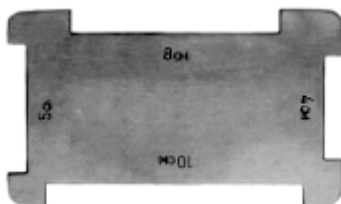

SKIN HOLDING/STRETCHING PLATE

Item Code	Description
21-005-001	FOR SCHINK DERMATOME



SILVER DERMATOME

Item Code	Description
21-006-001	19CM, ADJUSTABLE



LIP RETRACTOR

Item Code	Description
22-001-001	FOR UPPER JAW, 21CM



LIP RETRACTOR

Item Code	Description
22-002-001	FOR LOWER JAW, 26CM

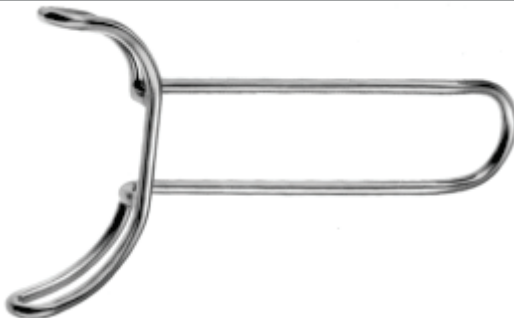

VESTIBULUM (UNIVERSAL) RETRACTOR

Item Code	Description
22-003-001	15CM

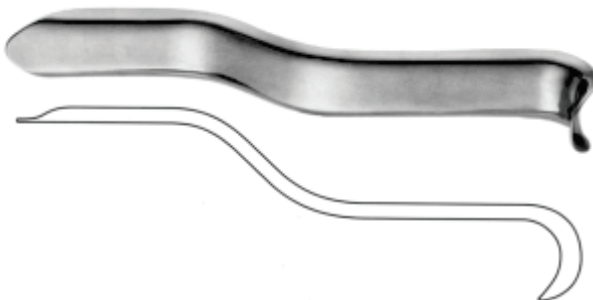

UNIVERSITY OF MINNESOTA CHEEK RETRACTOR

Item Code	Description
22-034-001	15.5CM

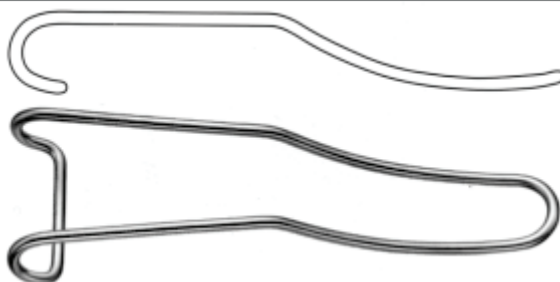

STERNBERG CHEEK RETRACTOR

Item Code	Description
22-035-001	14.5CM

3 mm



BLOCKSMA CLEFT PALATE HOOK, 18CM

Item Code	Description
23-001-001	1 PRONG
23-001-002	3MM, 2 PRONG

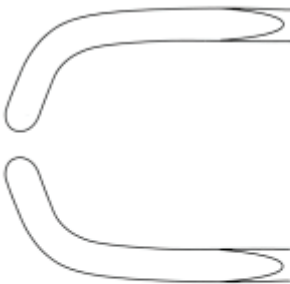

CLEFT PALATE RASPATORY, 14CM

Item Code	Description
23-002-001	#1 LEFT
23-002-002	#2 RIGHT



KAHRE CLEFT PALATE RASPATORY

Item Code	Description
23-003-001	17CM



MCINDOE CLEFT PALATE RASPATORY

Item Code	Description
23-004-001	16.5CM



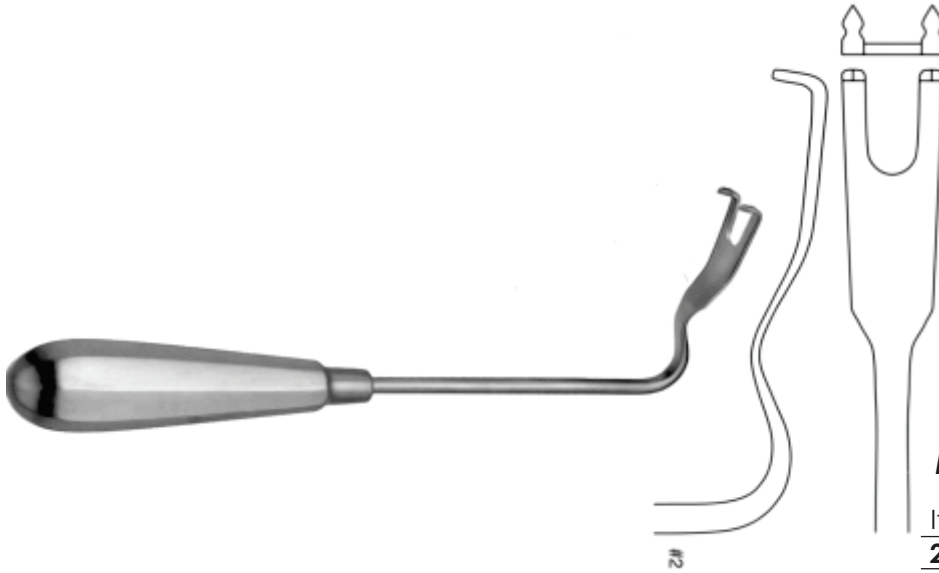

MUCOPERIOSTEAL RETRACTOR

Item Code	Description
23-005-001	19CM

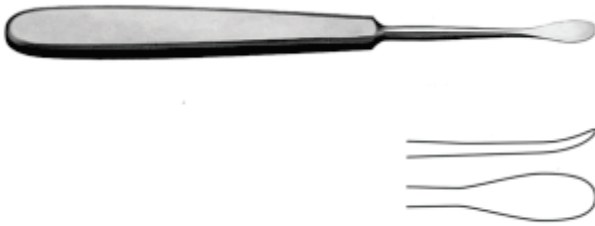

WANG CLEFT PALATE ELEVATOR

Item Code	Description
23-006-001	15.5CM

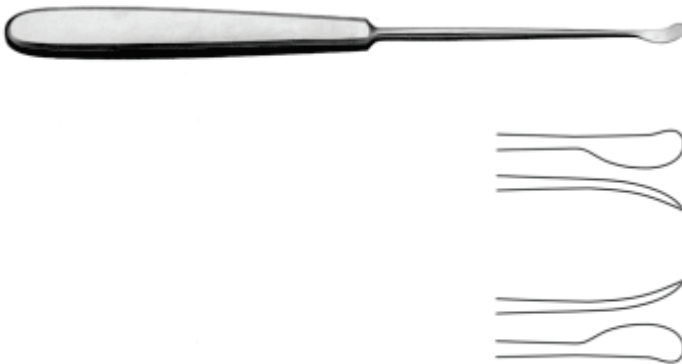

WANG CLEFT PALATE ELEVATOR, 18CM

Item Code	Description
23-007-001	RIGHT
23-007-002	LEFT
23-007-003	RIGHT ANGLED

23-007-004 LEFT ANGLED

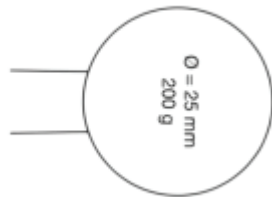

MALLET

Item Code	Description
24-001-001	18.5CM, PLASTIC FACINGS, 200 GRAMS, 25MM DIAMETER



MALLET, 26CM, NOVOTEX PLASTIC

Item Code	Description
24-002-001	150 GRAMS, 35MM DIAMETER
24-002-002	240 GRAMS, 45MM DIAMETER
24-002-003	330 GRAMS, 50MM DIAMETER



COTTLE MALLET, 19CM

Item Code	Description
24-003-001	1 PLAIN FACE, 1 CONVEX FACE



QUILLEN METAL HAMMER, 24CM

Item Code	Description
24-004-001	300 GRAMS, 30MMØ, ANGLED FACES

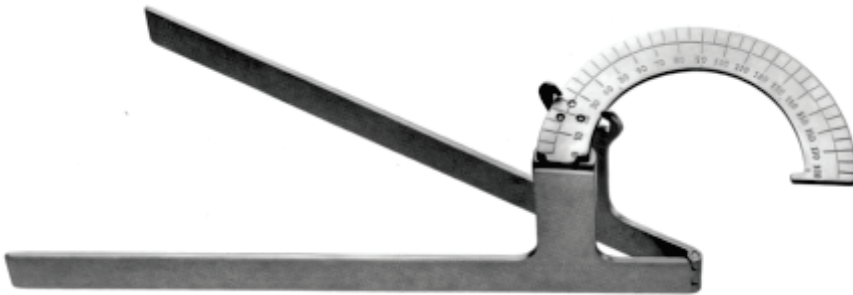

MOLTGEN FLEXOMETER

Item Code	Description
25-001-001	24CM



FINGER GONIOMETER

Item Code	Description
25-002-001	13CM



KNOCHEN MESSZIRKEL BONE BOW SPACER

Item Code	Description
25-003-001	19.5CM, SHARP TIPS

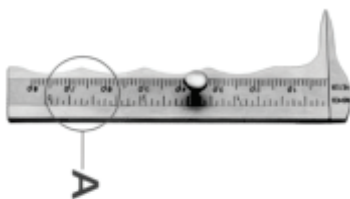

JAMESON CALIPER

Item Code	Description
25-004-001	10CM



THORPE CALIPER, 11CM

Item Code	Description
25-005-001	80MM MEASURING RANGE



CASTROVIEJO CALIPER, 8CM

Item Code	Description
25-006-001	20MM MEASURING RANGE



CASTROVIEJO CALIPER, 9CM

Item Code	Description
25-007-001	40MM MEASURING RANGE



CASTROVIEJO EPKER CALIPER, 18CM

Item Code	Description
25-008-001	STRAIGHT, 40MM MEASURING RANGE



CASTROVIEJO EPKER CALIPER, 18CM

Item Code	Description
25-009-001	ANGLED, 40MM MEASURING RANGE

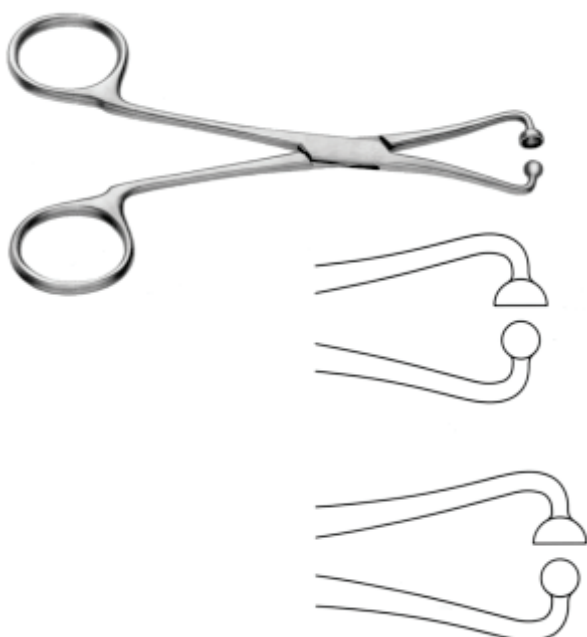

NOSE TIP MARKER

Item Code	Description
25-010-001	12CM, STRAIGHT
25-010-002	14.5CM, STRAIGHT



JOSEPH MEASURING ROD, 17CM

Item Code	Description
25-011-001	GRADUATED IN MILLIMETERS

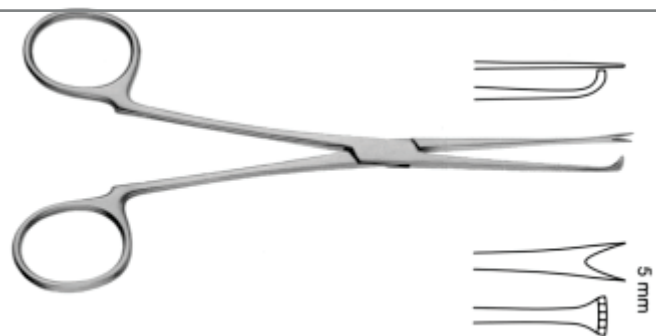

PITANGUY FACELIFT MARKER, 16CM

Item Code	Description
25-012-001	5MM WIDE



MARTEN FLAP MARKER, 5 3/4" (14.5 CM)

Item Code	Description
25-013-001	WITH RATCHET
25-013-002	WITHOUT RATCHET

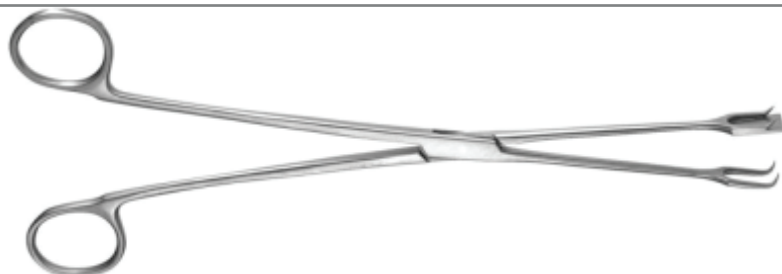

D ASSUMPCAO ABDOMINAL FLAP MARKER

Item Code	Description
25-014-001	10 MM WIDTH, 10" (254 MM) LENGTH



LOCKWOOD ABDOMINAL DEMARCATOR

Item Code	Description
25-015-001	11 MM WIDTH, WITH ANGLED HINGE, 12 1/4" (311 MM) LENGTH

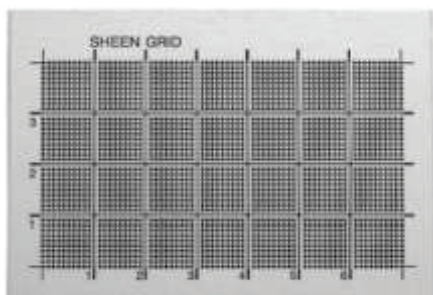

Sheen Grid Stainless Steel

Item Code	Description
25-016-001	Autoclavable, Grid Dimensions are 40 X 70 mm



NAVAL MARKER

Item Code	Description
25-017-001	11 3/8" (29cm)

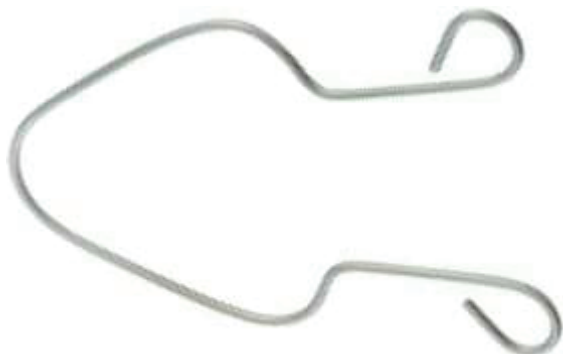

ACKERMAN BREAST MARKER

Item Code	Description
25-018-001	5 1/2" (14 CM), SMALL
25-018-002	6 1/4" (16 CM), LARGE



MCKISSOCK KEYHOLE PATTERN

Item Code	Description
25-019-001	38 MM DIAMETER, WITH CM MARKINGS
25-019-002	42 MM DIAMETER, WITH CM MARKINGS
25-019-003	45 MM, DIAMETER, WITH CM MARKINGS

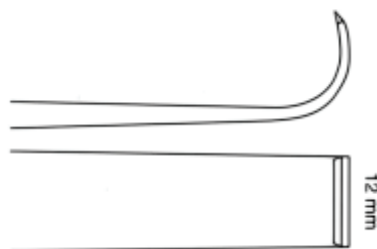

OBWEGESER MAXILLA MOBILIZING INSTRUMENT

Item Code	Description
25-020-001	23CM, 12MM

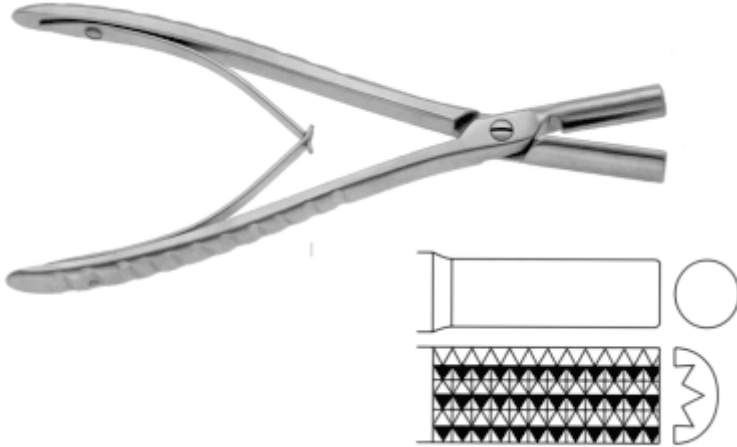

OBWEGESER, BONE BENDING PLIERS

Item Code	Description
<u>26-001-001</u>	<u>17.5cm/7"</u>

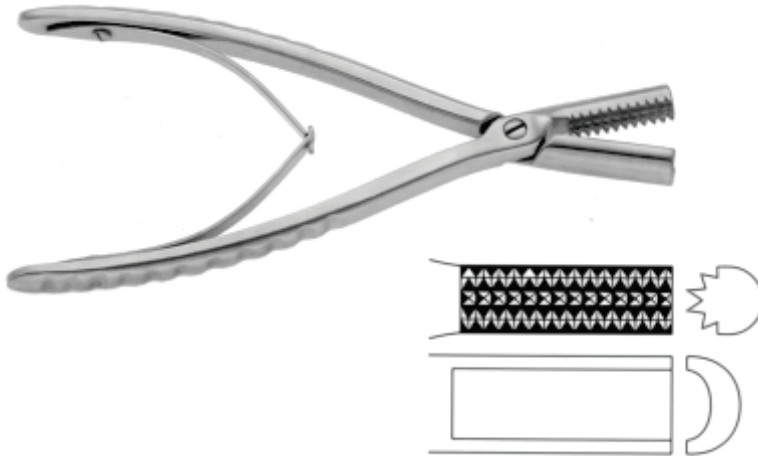

OBWEGESER, BONE BENDING PLIERS

Item Code	Description
<u>26-002-001</u>	<u>17.5cm/7"</u>

Septal Morslizer Forceps
with protective guard

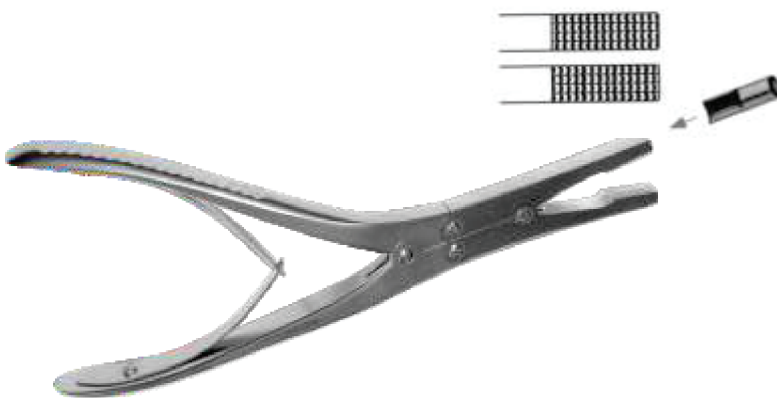

RUBIN FORCEPS

Item Code	Description
<u>26-003-001</u>	<u>20cm/8"</u>



GENERAL SURGERY INSTRUMENTS





SCALPEL HANDLE, NO.3

Item Code	Description
27-001-001	12.5cm/5"



SCALPEL HANDLE, NO.7

Item Code	Description
27-002-001	16.5cm/6½"



SCALPEL HANDLE, NO.7K

Item Code	Description
27-003-001	12cm/4¾"



SCALPEL HANDLE, NO.3L

Item Code	Description
27-004-001	21cm/8¼"



SCALPEL HANDLE, NO.3LA

Item Code	Description
27-005-001	20.5cm/8"



ROUND SCALPEL HANDLE

Item Code	Description
27-006-001	15.5cm/6 1/8"

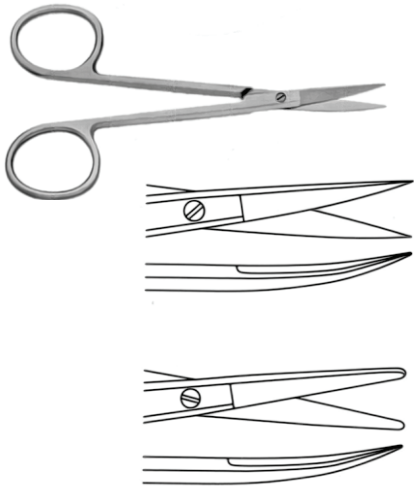

**COTTLE MASING RHINOPLASTY
SCISSORS, 10CM, CURVED BLADE**

Item Code	Description
29-001-001	SHARP
29-001-001	BLUNT



COTTLE BULLDOG SCISSORS

Item Code	Description
29-002-001	11.5CM

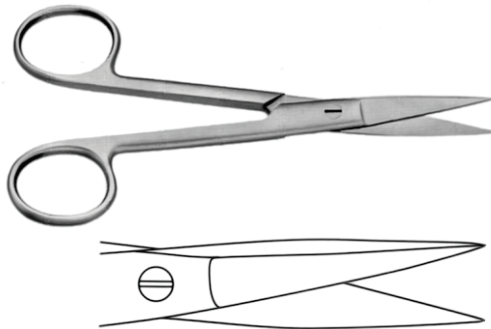

CONVERSE SCISSORS

Item Code	Description
29-003-001	13.5CM, DOUBLE EDGED, OUTER EDGES SEMI SHARP

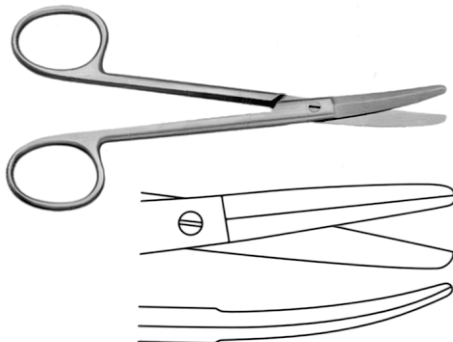

FOMON RHINOPLASTY SCISSORS, 12.5CM

Item Code	Description
29-004-001	WITH OUTER CUTTING, BOTH SIDES SHARP

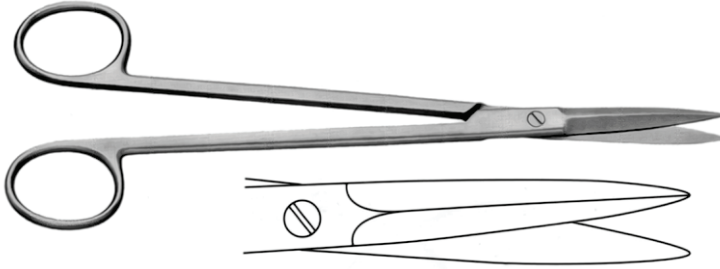

MCINDOE RHINOPLASTY SCISSORS

Item Code	Description
29-005-001	19CM, STRAIGHT, SERRATED



AUFRICHT NASAL SCISSORS, 14CM, BLUNT

STANDARD	SUPERCUT	TC	SUPERCUT PLUS
29-006-001	29-006-002	29-006-003	29-006-004



GIUNTA T.C. NASAL SCISSORS

Item Code	Description
29-007-001	13.5CM, CURVED

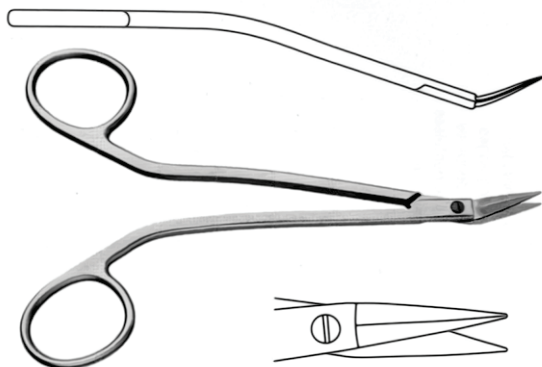

WALTER DORSAL SCISSORS 14CM, ANGULAR

STANDARD	SUPERCUT	TC	SUPERCUT PLUS
29-008-001	29-008-002	29-008-003	29-008-004

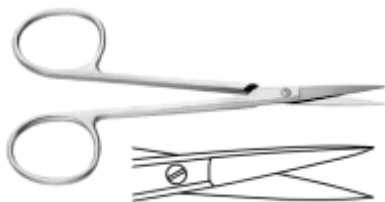

IRIS SCISSORS, STRAIGHT

	STANDARD	SUPERCUT	TC	SUPERCUT PLUS
3½" (9cm)	29-009-001	29-009-005	29-009-009	29-009-013
4¼" (10.5cm)	29-009-002	29-009-006	29-009-010	29-009-014
4½" (11.5cm)	29-009-003	29-009-007	29-009-011	29-009-015
5" (12.5cm)	29-009-004	29-009-008	29-009-012	29-009-016



IRIS SCISSORS, CURVED

	STANDARD	SUPERCUT	TC	SUPERCUT PLUS
3½" (9cm)	29-010-001	29-010-005	29-010-009	29-010-013
4¼" (10.5cm)	29-010-002	29-010-006	29-010-010	29-010-014
4½" (11.5cm)	29-010-003	29-010-007	29-010-011	29-010-015
5" (12.5cm)	29-010-004	29-010-008	29-010-012	29-010-016

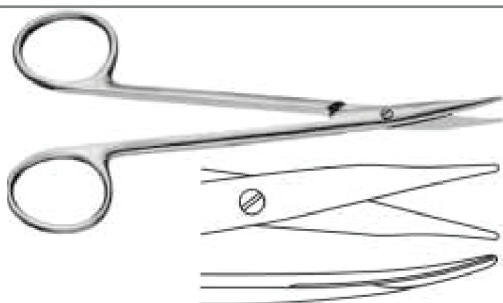

STEVEN SCISSORS, 5 1/8" (13cm)

STANDARD	SUPERCUT
29-011-001	29-011-002



MAYO SCISSORS, STRIAGHT

	STANDARD	SUPERCUT	TC	SUPERCUT PLUS
14 cm	29-012-001	29-012-03	29-012-05	29-012-07
17 cm	29-012-002	29-012-04	29-012-06	29-012-08

MAYO SCISSORS, STRIAGHT

	STANDARD	SUPERCUT	TC	SUPERCUT PLUS
14 cm	29-012-009	29-012-11	29-012-13	29-012-15
17 cm	29-012-010	29-012-12	29-012-14	29-012-16



MAYO STILLE SCISSORS

	STANDARD	SUPERCUT	TC	SUPERCUT PLUS
15 cm	29-013-001	29-013-03	29-013-05	29-013-07
17 cm	29-013-002	29-013-04	29-013-06	29-013-08



METZENBAUM SCISSORS

	STANDARD	SUPERCUT	TC	SUPERCUT PLUS
14 cm	29-014-001	29-014-004	29-014-007	29-014-010
18 cm	29-014-002	29-014-005	29-014-008	29-014-011
20 cm	29-014-003	29-014-006	29-014-009	29-014-012



NELSON METZENBAUM SCISSORS

	STANDARD	SUPERCUT	TC	SUPERCUT PLUS
23 cm	29-015-001	29-015-004	29-015-007	29-015-010
26 cm	29-015-002	29-015-005	29-015-008	29-015-011
30 cm	29-015-003	29-015-006	29-015-009	29-015-012



FANOUS SCISSORS

	STRAIGHT STANDARD	STRAIGHT SUPERCUT	CURVED STANDARD	CURVED SUPERCUT
16.5 cm	29-016-001	29-016-003	29-016-005	29-016-007
20.5 cm	29-016-002	29-016-004	29-016-006	29-016-008

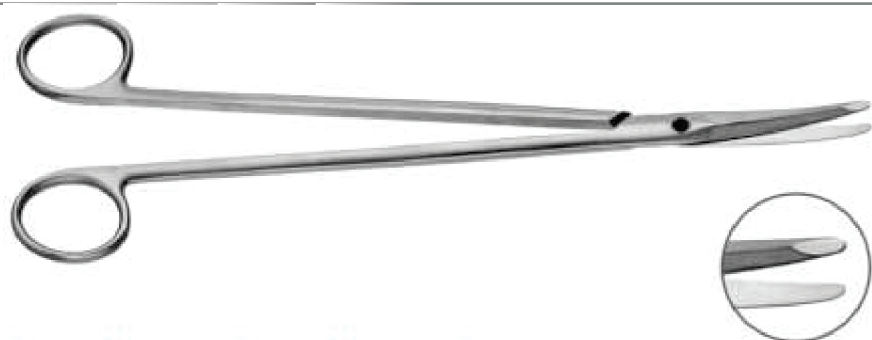

GORNEY SCISSORS

	STANDARD	SUPERCUT	TC	SUPERCUT PLUS
17 cm	29-017-001	29-017-004	29-017-007	29-017-010
19 cm	29-017-002	29-017-005	29-017-008	29-017-011
23 cm	29-017-003	29-017-006	29-017-009	29-017-012

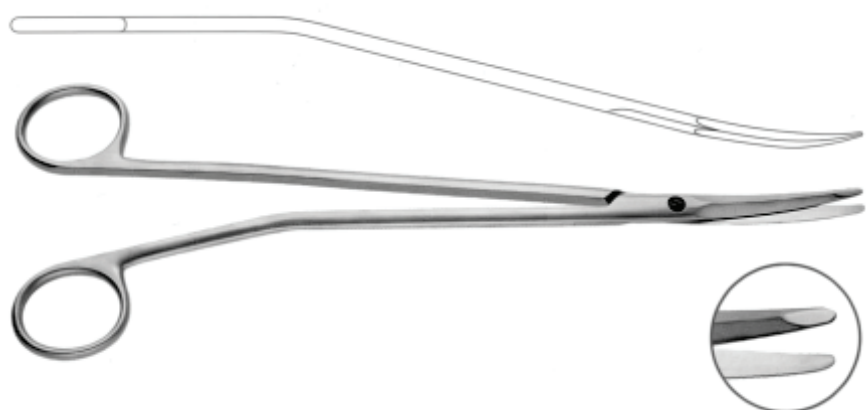

GORNEY FREEMAN SCISSORS

	STANDARD	SUPERCUT	TC	SUPERCUT PLUS
23 cm	29-018-001	29-018-002	29-018-003	29-018-004

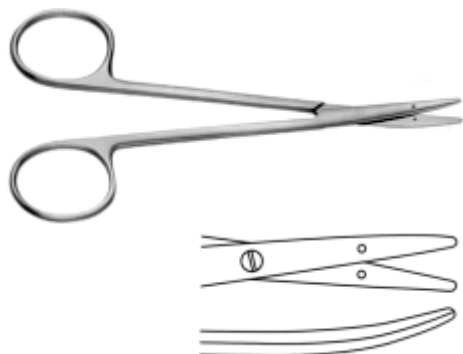

LITTLER SCISSORS,

Item Code	Description
X27-019-001	STANDARD, 4 ³ / ₄ " (12cm)

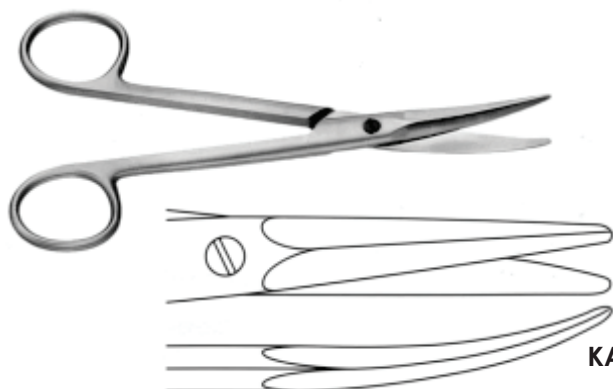

KAYE SCISSORS

	STANDARD	SUPERCUT	TC	SUPERCUT PLUS
15 cm	29-020-001	29-020-003	29-020-005	29-020-007
17 cm	29-020-002	29-020-004	29-020-006	29-020-008

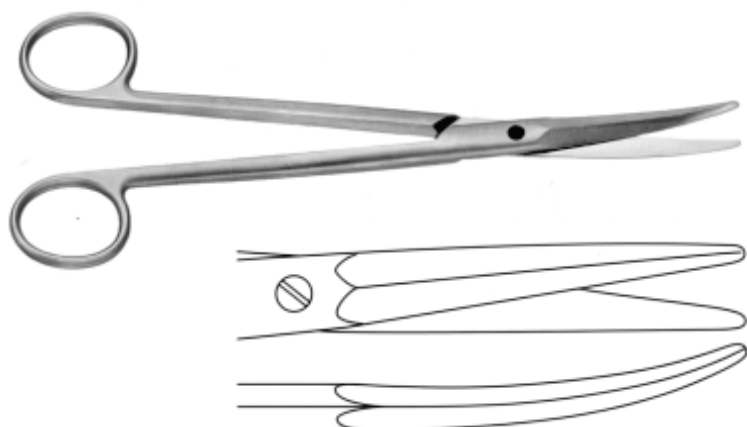

KAYE SCISSORS

	STANDARD	SUPERCUT	TC	SUPERCUT PLUS
19 cm	29-021-001	29-021-003	29-021-005	29-021-007
23 cm	29-021-002	29-021-004	29-021-006	29-021-008



BLEPHAROPLASTY SCISSORS

Item Code	Description
X27-023-001	SUPERCUT, 4½" (11.5cm)

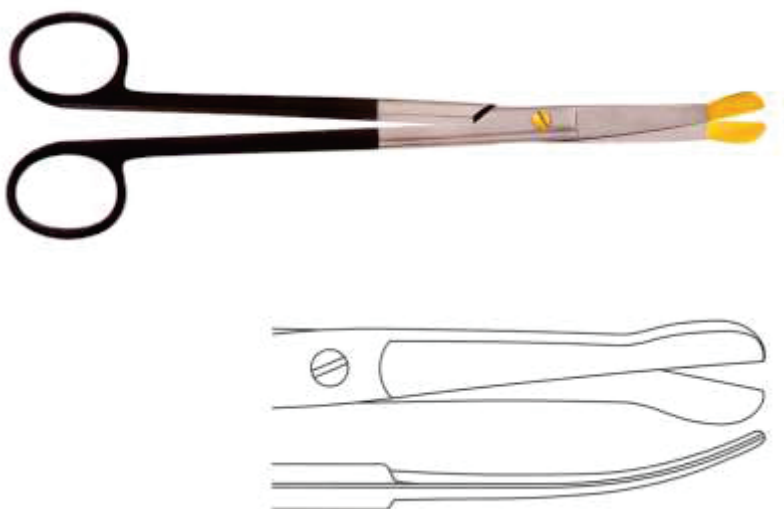

SOLZ SCISSORS

	STANDARD	SUPERCUT	TC	SUPERCUT PLUS
20 cm	29-024-001	29-024-002	29-024-003	29-024-004

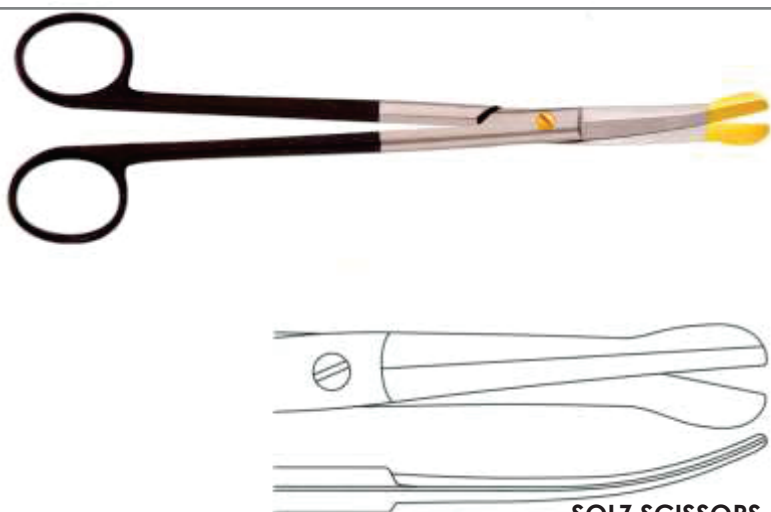

SOLZ SCISSORS

	STANDARD	SUPERCUT	TC	SUPERCUT PLUS
20 cm	29-025-001	29-025-002	29-025-003	29-025-004

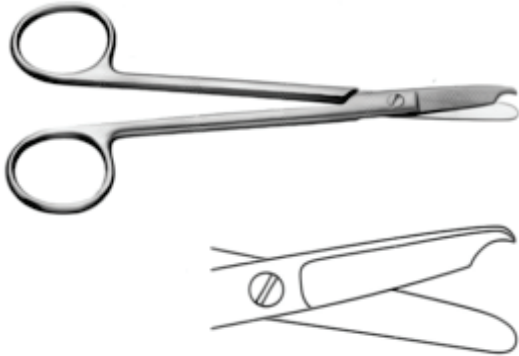

LITTAUER SCISSORS

Item Code	Description
29-026-001	5 1/8" (13cm)



serrated cutting edge
wire cutting scissors
hard wire | \varnothing 0.8mm max
soft wire | \varnothing 1.2mm max

UNIVERSAL SCISSORS

Item Code	Description
29-027-001	4 3/4" (12cm)

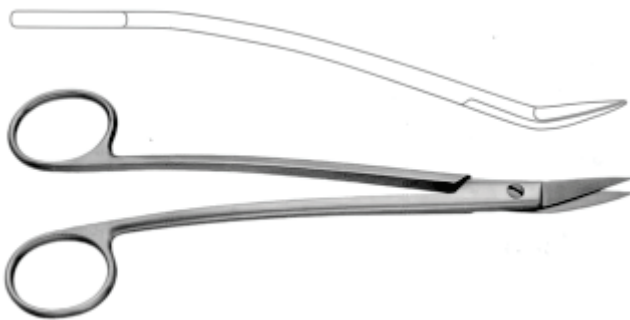

DEAN SCISSORS

	STANDARD	SUPERCUT
17 cm	29-028-001	29-028-002



HEYMANN SCISSORS

	STANDARD	SUPERCUT
17 cm	29-029-001	29-039-002

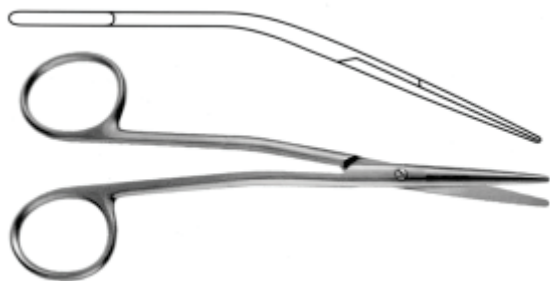

FOMON SCISSORS

13 cm	STANDARD 29-030-001	SUPERCUT 29-030-002	TC 29-030-003	SUPERCUT PLUS 29-030-004
-------	-------------------------------	-------------------------------	-------------------------	------------------------------------



WALTER SCISSORS

14 cm	STANDARD 29-031-001	SUPERCUT 29-031-002
-------	-------------------------------	-------------------------------

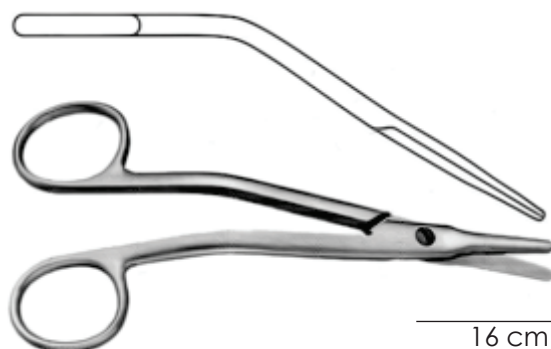

WALTER COTTLE SCISSORS

16 cm	STANDARD 29-032-001	SUPERCUT 29-032-002	TC 29-032-003	SUPERCUT PLUS 29-032-004
-------	-------------------------------	-------------------------------	-------------------------	------------------------------------

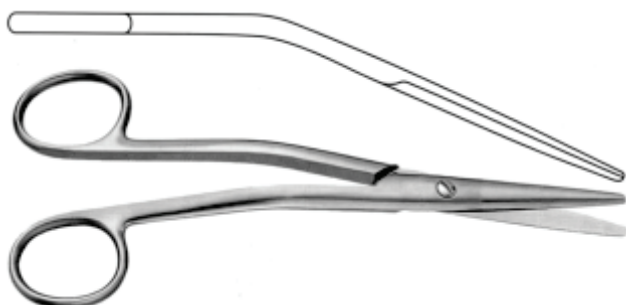

COTTLE SCISSORS

16 cm	STANDARD 29-033-001	SUPERCUT 29-033-002	TC 29-033-003	SUPERCUT PLUS 29-033-004
-------	-------------------------------	-------------------------------	-------------------------	------------------------------------

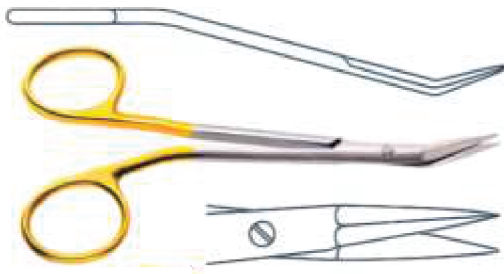

GIUNTA SCISSORS

13.5 cm	STANDARD 29-034-001	SUPERCUT 29-034-002	TC 29-034-003	SUPERCUT PLUS 29-034-004
---------	-------------------------------	-------------------------------	-------------------------	------------------------------------



outer edges
semi sharp

CONVERSE SCISSORS

13.5 cm	STANDARD 29-035-001	SUPERCUT 29-035-002	TC 29-035-003	SUPERCUT PLUS 29-035-004
---------	-------------------------------	-------------------------------	-------------------------	------------------------------------



COTTLE MASING SCISSORS, 10 CM

	STANDARD
SHARP	29-036-001
BLUNT	29-036-002



Bulldog Scissors

COTTLE SCISSORS, 11.5 CM

11.5 cm	STANDARD 29-037-001
---------	-------------------------------

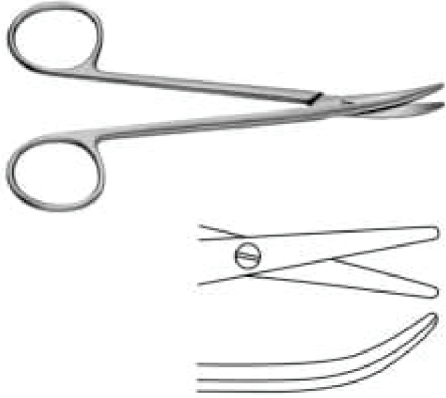

CINELLI SCISSORS

	STANDARD
11 cm	29-038-001



with outer cutting,
both sides sharp

FOMON SCISSORS

	STANDARD
12.5 cm	29-039-001



serrated cutting edge

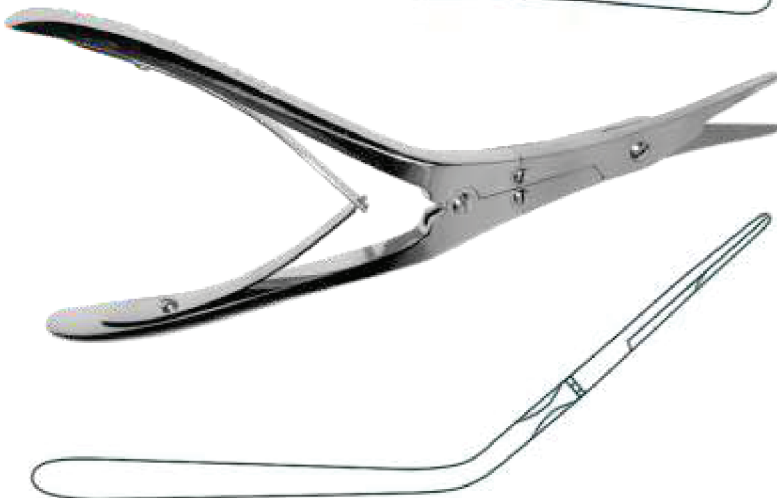

Nasal Septum Scissors

CAPLAN SCISSORS

Item Code	Description
29-040-001	20cm/ 8"



TISSUE FORCEPS

Item Code	Description
30-001-001	14.5cm/5 ¾"



ADSON FORCEPS

Item Code	Description
30-002-001	12cm/4 ¾"



ADSON FORCEPS,TC

Item Code	Description
30-003-001	12cm/4 ¾"



ADSON FORCEPS,TC

Item Code	Description
30-004-001	15cm/6"



HUDSON-EWALD FORCEPS

Item Code	Description
30-005-001	SERRATED, 12cm/4¾"



HUDSON-EWALD FORCEPS

Item Code	Description
30-006-001	1X2 TEETH, 12cm/4¾"



ADSON FORCEPS

Item Code	Description
30-007-001	1X2 TEETH, 15cm/6"



ADSON FORCEPS, TC

Item Code	Description
30-008-001	1X2 TEETH, 12cm/4¾"



ADSON FORCEPS, TC

Item Code	Description
30-009-001	1X2 TEETH, 15cm/6"



ADSON BROWN FORCEPS, 12cm/4¾"

Item Code	Description
30-010-001	7X7 TEETH
30-010-002	9X9 TEETH



ADSON BROWN FORCEPS

Item Code	Description
30-011-001	12cm/ 4¾"



ADSON GRAEFE BROWN FORCEPS

Item Code	Description
30-012-001	12cm/ 4¾"



SEMKEN FORCEPS

Item Code	Description
30-013-001	12.5cm/ 5"



SEMKEN FORCEPS

Item Code	Description
30-014-001	SERRATED, STRAIGHT, 12.5cm/5"
30-014-002	SERRATED, CURVED, 12.5cm/5"
30-014-003	SERRATED, STRAIGHT, 15cm/6"
30-014-004	SERRATED, CURVED, 15cm/6"

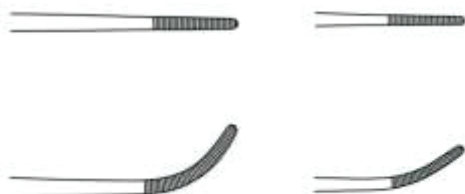

SEMKEN FORCEPS

Item Code	Description
30-015-001	1X2 TEETH, STRAIGHT, 12.5cm/5"
30-015-002	1X2 TEETH, CURVED, 12.5cm/5"
30-015-003	1X2 TEETH, STRAIGHT, 15cm/6"
30-015-004	1X2 TEETH, CURVED, 15cm/6"

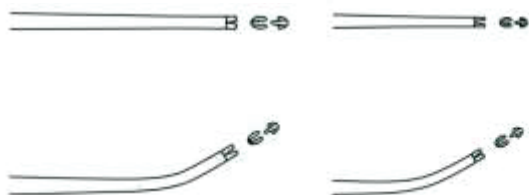

MCINDOE FORCEPS

Item Code	Description
30-016-001	SERRATED, 15cm/6"



GILLIES FORCEPS

Item Code	Description
30-017-001	SERRATED, 1X2 TEETH, 15cm/6"



WAUGH FORCEPS

Item Code	Description
30-018-001	CROSS SERRATION, 15cm/6"
30-018-002	CROSS SERRATION, 1X2 TEETH, 15cm/6"





Item Code	Description
30-019-001	FORCEPS, SERRATED, 20cm/8"



DEBAKEY "AT" FORCEPS

Item Code	Description
30-020-001	15cm/6"

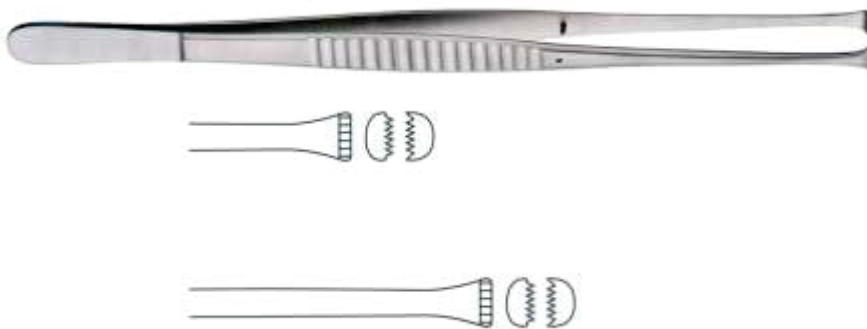

NELSON FORCEPS

Item Code	Description
30-021-001	15cm/6"
30-021-002	23cm/9"



WALTER FORCEPS

Item Code	Description
30-022-001	16m/6¼"



WALTER FORCEPS

Item Code	Description
30-023-001	16m/6¼"



GRUENWALD FORCEPS

Item Code	Description
30-023-001	16 cm/ 6 1/4"



TROELTSCH (WILDE) FORCEPS

Item Code	Description
30-024-001	13 cm/ 5 1/8"

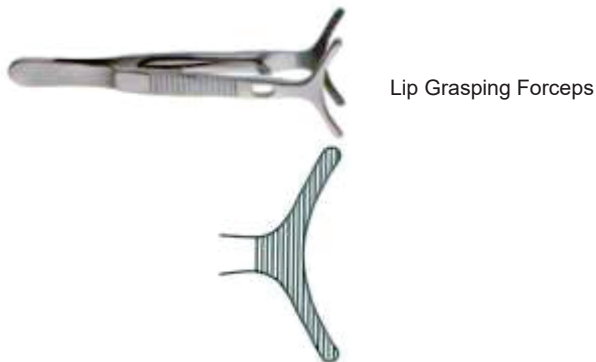

WALTER FORCEPS

Item Code	Description
30-025-001	8 cm/ 3 1/8"

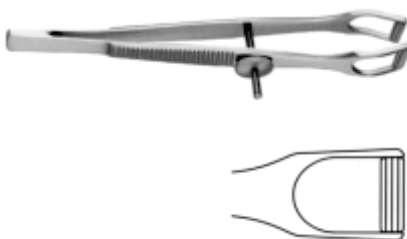

COTTLE FORCEPS

Item Code	Description
30-026-001	15 cm/ 6"



FOX FORCEPS

Item Code	Description
30-027-001	15 cm/ 6"



HALSTED MOSQUITO FORCEPS

Item Code	Description
31-001-001	STRAIGHT 12.5cm/5"
31-001-002	CURVED 12.5cm/5"

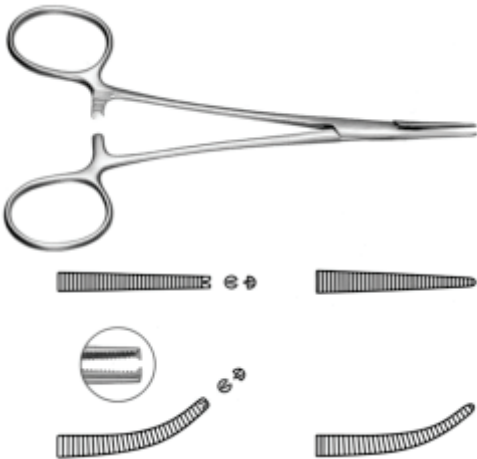

MICRO MOSQUITO FORCEPS

Item Code	Description
31-002-001	STRAIGHT 12.5cm/5"
31-002-002	CURVED 12.5cm/5"
31-002-003	STRAIGHT, 1X2 TEETH, 12.5cm/5"
31-002-004	CURVED, 1X2 TEETH, 12.5cm/5"

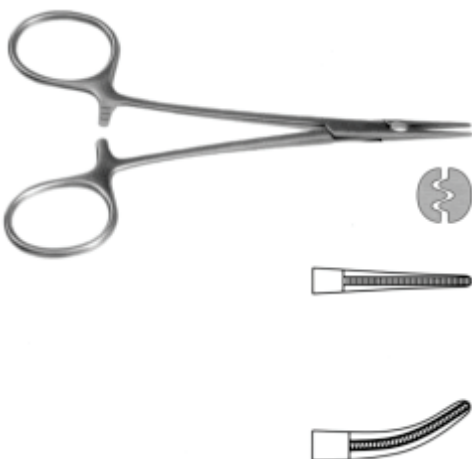

Atraumatic Serration

MOSQUITO "AT" FORCEPS

Item Code	Description
31-003-001	STRAIGHT 12.5cm/5"
31-003-002	CURVED 12.5cm/5"



MICRO JACOBSON FORCEPS

Item Code	Description
31-004-001	STRAIGHT 12.5cm/5"
31-004-002	CURVED 12.5cm/5"



MICRO JACOBSON FORCEPS

Item Code	Description
31-005-001	STRAIGHT 12.5cm/5"
31-005-002	CURVED 12.5cm/5"



HALSTED MOSQUITO FORCEPS

Item Code	Description
31-006-001	STRAIGHT 10cm/4"
31-006-002	CURVED 10cm/4"
31-006-003	STRAIGHT, 1X2 TEETH, 12.5cm/5"
31-006-004	CURVED, 1X2 TEETH, 12.5cm/5"



PROVIDENCE HOSPITAL FORCEPS, 14cm/5½"

Item Code	Description
31-007-001	STRAIGHT
31-007-002	CURVED,
31-007-003	STRAIGHT, 1X2 TEETH
31-007-004	CURVED, 1X2 TEETH



LERICHE FORCEPS, 15cm/ 6"

Item Code	Description
31-008-001	STRAIGHT
31-008-002	CURVED
31-008-003	STRAIGHT, 1X2 TEETH
31-008-004	CURVED, 1X2 TEETH



COLLIER NEEDLE HOLDER

Item Code	Description
32-001-001	13 cm/ 5 1/8"

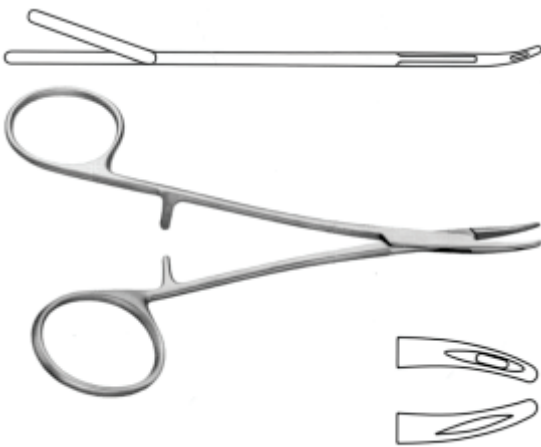

CONVERSE NEEDLE HOLDER

Item Code	Description
32-002-001	15 cm/ 6"

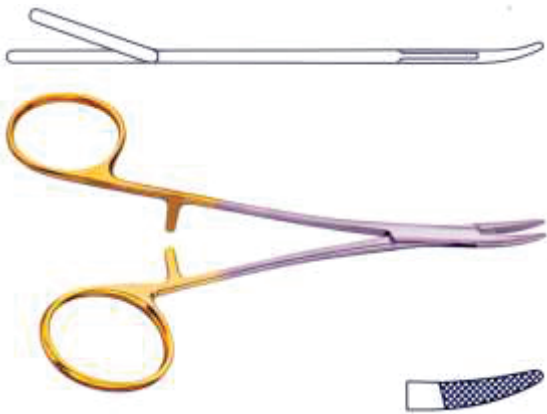

CONVERSE NEEDLE HOLDER

Item Code	Description
32-003-001	TC, 15 cm/ 6"

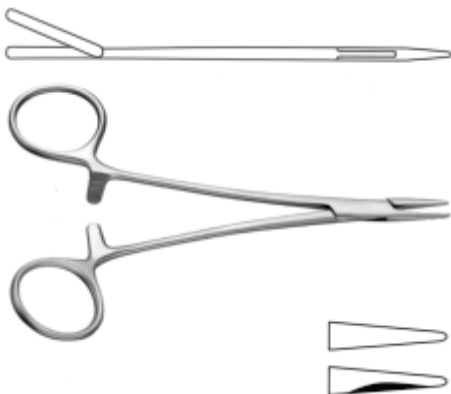

NEIVERT NEEDLE HOLDER

Item Code	Description
32-004-001	12 cm/ 5"



NEEDLE HOLDER, TC

Item Code	Description
32-005-001	11.5 cm/ 4½"
32-005-002	13 cm/ 5 1/8"



NEIVERT NEEDLE HOLDER

Item Code	Description
32-006-001	TC, 12.5 cm/ 5"



WRIGHT (DERF) NEEDLE HOLDER

Item Code	Description
32-007-001	12.5 cm/ 5"



NEEDLE HOLDER

Item Code	Description
32-008-001	TC, 12.5 cm/ 5"



WRIGHT (DERF) NEEDLE HOLDER

Item Code	Description
32-009-001	TC, 12.5 cm/ 5"



HALSEY NEEDLE HOLDER

Item Code	Description
32-010-001	13.5 cm/ 5 3/8"



HALSEY NEEDLE HOLDER

Item Code	Description
32-011-001	TC, 13.5 cm/ 5 3/8"

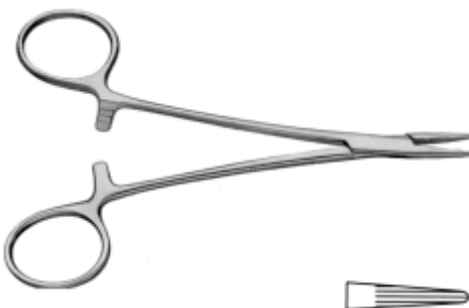

DERF CONVERSE NEEDLE HOLDER

Item Code	Description
32-012-001	TC, 12.5 cm/ 5"



CRILE WOOD NEEDLE HOLDER

Item Code	Description
32-013-001	15 cm/ 6"
32-013-002	18 cm/ 7 1/8"
32-013-003	20 cm/ 8"
32-013-004	23 cm/ 9"



CRILE WOOD NEEDLE HOLDER, TC

Item Code	Description
32-014-001	15 cm/ 6"
32-014-002	18 cm/ 7 1/8"
32-014-003	20 cm/ 8"
32-014-004	23 cm/ 9"
32-014-005	25 cm/ 10"
32-014-006	30 cm/ 11 3/4"

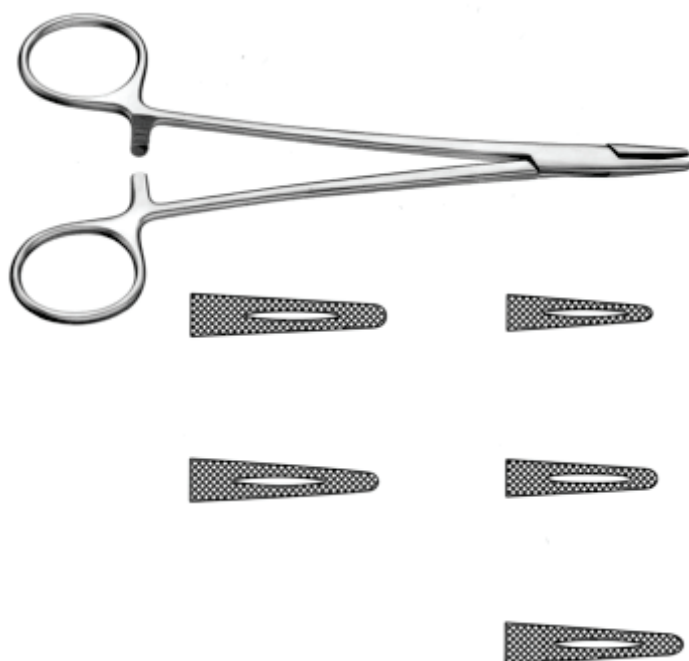

MAYO HEGAR NEEDLE HOLDER

Item Code	Description
32-015-001	15 cm/ 6"
32-015-002	18 cm/ 7 1/8"
32-015-003	23 cm/ 9"
32-015-004	24 cm/ 9 1/2"

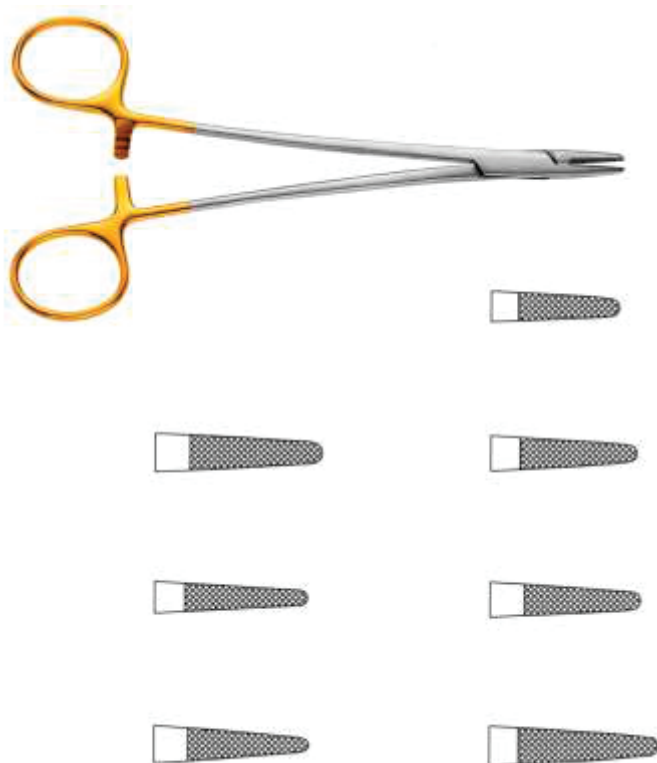

MAYO HEGAR NEEDLE HOLDER, TC

Item Code	Description
32-016-001	15 cm/ 6"
32-016-002	18 cm/ 7 1/8"
32-016-003	23 cm/ 9"
32-016-004	24 cm/ 9 1/2"
32-016-005	26 cm/ 10 1/4"
32-016-006	30 cm/ 11 3/4"



GILLIES SLIM NEEDLE HOLDER

Item Code	Description
32-017-001	14.5 cm/ 5¾"

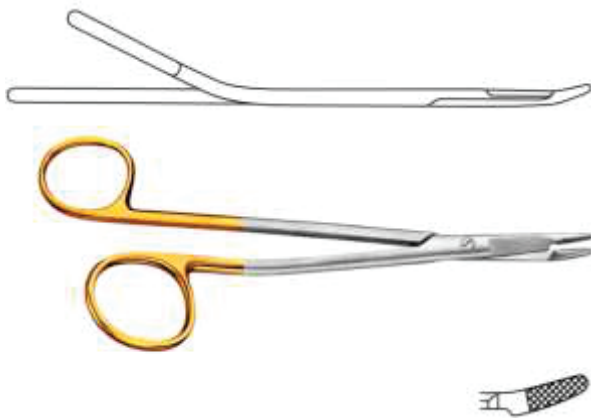

GILLIES SLIM NEEDLE HOLDER, TC

Item Code	Description
32-018-001	14.5 cm/ 5¾"



GILLIES NEEDLE HOLDER

Item Code	Description
32-019-001	15.5 cm/ 6 1/8"



VESSEL DILATOR

Item Code	Description
33-001-001	ANGLED, 11cm/ 4¼", 0.2mmØ



VESSEL DILATOR

Item Code	Description
33-002-001	ANGLED, 11cm/ 4¼", 0.3mmØ



VESSEL DILATOR

Item Code	Description
33-003-001	ANGLED, 13.5cm/ 5 3/8", 0.2mmØ



VESSEL DILATOR

Item Code	Description
33-004-001	LONG ANGLED, 13.5cm/ 5 3/8", 0.2mmØ



VESSEL DILATOR

Item Code	Description
33-005-001	LONG ANGLED, 18cm/ 7", .3mmØ



VESSEL DILATOR

Item Code	Description
33-006-001	LONG ANGLED, 18cm/ 7", 0.2mmØ



ROUND BODIED VESSEL DILATOR

Item Code	Description
33-007-001	15cm/ 6", 0.3mmØ, BALANCED FORCEPS



ROUND BODIED VESSEL DILATOR

Item Code	Description
33-008-001	CURVED, 15cm/ 6", 0.2mmØ, BALANCED FORCEPS



ROUND BODIED VESSEL DILATOR

Item Code	Description
33-009-001	18cm/ 7", 0.3mmØ, BALANCED FORCEPS



ROUND BODIED VESSEL DILATOR

Item Code	Description
33-010-001	CURVED, 18cm/ 7", 0.3mmØ, BALANCED FORCEPS



JEWELLERS FORCEPS

Item Code	Description
33-011-001	11cm/ 4¼", 0.3mmØ



JEWELLERS FORCEPS

Item Code	Description
33-012-001	LONG, 15cm/ 6", 0.3mmØ



JEWELLERS FORCEPS

Item Code	Description
33-013-001	12cm/ 4¾", 0.3mmØ



JEWELLERS FORCEPS

Item Code	Description
33-014-001	13.5cm/ 5 3/8", 0.3mmØ



Pierse Forceps have a micro hole in the tips which securely grip tissue with minimal trauma



PIERSE FORCEPS

Item Code	Description
33-015-001	12cm/ 4 3/4", 0.3mmØ



MICRO ADSON FIXATION FORCEPS

Item Code	Description
33-016-001	12cm/ 4 3/4", 0.3mmØ, 1X2 MICRO TEETH



ROUND BODIED FORCEPS

Item Code	Description
33-017-001	15cm/ 6", STRAIGHT, WITH PLATFORM, 0.3mmØ



ROUND BODIED FORCEPS

Item Code	Description
33-018-001	15cm/ 6", CURVED, WITH PLATFORM, 0.3mmØ



ROUND BODIED FORCEPS

Item Code	Description
33-019-001	15cm/ 6", ANGLED, 0.2mmØ



ROUND BODIED FORCEPS

Item Code	Description
33-020-001	18cm/ 7", STRAIGHT, 0.5mmØ



Abdomino Plasty (Tummy Tuck) Set Detail:

- Knife Handle No. 3
- Halsted Mosquito Forceps, curved
- Mayo-Hegar Needle Holder, TC
- Webster Needle Holder, TC, smooth jaws
- Adson Tissue Forceps, 1 x 2 teeth & Cross Serrated
- Joseph Hook, sharp
- Mayo Scissors, straight
- Gorney Freeman Scissors, SC, curved
- Metzenbaum Scissors, SC, curved
- Stevens Tenotomy Scissors, SC, curved
- Lahey Forceps, 3 x 3 teeth
- Allis Tissue Forceps, 5 x 6 teeth
- Brown-Adson Forceps, 9 x 9 teeth
- US Army Retractor, 2/set
- Tissue Forceps, 1 x 2 teeth
- Iris Scissors, TC, straight
- Yancoskie Retractor, 6 prongs
- Freeman Retractor, 4 prongs, 22mm
- Freeman Retractor, 4 prongs, 38mm
- Meyerding Retractor, large
- Lockwood Abdominal Demarcator



ABDOMINOPLASTY SET, Consisting of;

- Scalpel blades #15
- Scalpel blades #21
- Scalpel handle, #7
- Scalpel handle, #4l long
- Ragnell kilner scissors, 13cm, curved - flattened at distal end
- Adson delicate tissue and suture forceps, 15cm, 1x2 teeth
- Adson brown delicate tissue forceps, 12cm, 9x9 teeth, straight - atraumatic
- Potts smith tissue forceps, 20cm, 1x2 teeth - delicate
- Allis Tissue Forcep 5X6 teeth, 16cm
- Wright derf t.c. needle holder, 12.5cm, serrated
- Mayo hegar t.c. needle holder, 15cm
- Mayo hegar t.c. needle holder, 23cm
- Backhaus towel clamp, 8.5cm
- Joseph skin hook, double prong, sharp, 16cm, 10mm wide
- Stevens Supercut Tenotomy Scissors, 10.5cm, Curved, Blunt - Delicate
- Supercut mayo scissors, 14cm, straight
- Supercut gorney scissors, 23cm, curved
- Supercut gorney freeman scissors, 23cm, curved "gold tip"
- Supercut scissors, 20cm, curved, slight bevel on shank, "gold tip"
- Supercut scissors, 20cm, curved, strong bevel on shank
- Farabeuf baby retractors, 12cm, double ended, set of 2
- Israel retractor, 25cm, 6 blunt prongs, 60mm wide x 50mm deep
- Saldanha solz abdominal retractor, 37cm



BLEPHAROPLASTY SET Consisting of:

- Scalpel Handle, #3 Standard
- Stevens Scissors, 11.5cm, Curved - Sharp
- Stevens Scissors, 11.5cm, Curved - Blunt
- Neivert Needle Holder, 12.5cm
- Halsted Mosquito Forceps, 12.5cm, Curved
- Backhaus Towel Clamp, 8.5cm
- Gillies Dura And Skin Retractor Hook, 19cm, Small
- Joseph Delicate Retractor, 17cm, 2 Prong, 5mm, Sharp
- Joseph Delicate Tracheal Retractor, 16cm, 2 Prong, 8mm, Blunt
- Supercut Mayo Scissors, 14cm, Straight
- Desmarres Lid Retractor #1, 14cm, Small, 9x12mm
- Castroviejo Measuring guage 7 cm, Measuring Guage 20 mm,
- Bishop Harmon Iris Forceps, 1X2 teeth, 0.3 mm
- Castroviejo Suturing Forceps, 1X2 teeth, 0.9 mm



Breast Augmentation Set :

- | | |
|---|--|
| Knife Handle No. #3 | Webster Needle Holder, TC, smooth jaws |
| Halsted Mosquito Forceps, curved | Halsey Needle Holder, TC, smooth jaws |
| Metzenbaum Scissors, SC, curved | McKissock Mammoplasty Caliper |
| Gorney Freeman Scissors, SC, curved | Flexible Ruler |
| Mayo Scissors, straight | Spatula Breast Dissector |
| Iris Scissors, TC, straight | Walther Sound 32FR |
| Yankauer Suction Tube | Silverstein Breast Dissector |
| Frazier Suction Tube, 12 FR | Joseph Hook, sharp |
| Adson Dressing Forceps | Senn Retractor, sharp |
| Adson Tissue & Suture Forceps, 1 x 2 teeth w/tying platform | US Army Retractor, 2/set |
| Brown-Adson Forceps, 9 x 9 teeth | Freeman Retractor, 4 prong, 38mm |
| Tissue Forceps, 1 x 2 teeth | Pediatric Ribbon Retractor, malleable |
| Dressing Forceps, serrated | Ferreira Fiber Optic Retractor |
| Freeman Areola Marker, 38mm | Deaver Fiber Optic Retractor |
| Freeman Areola Marker, 42mm | TBTS Fiber Optic Retractor, with teeth |
| Freeman Areola Marker, 45mm | |
| Freeman Areola Marker, 50mm | |
| McKissock Breast Marker, 38mm, Keyhole pattern | |
| McKissock Breast Marker, 42mm, Keyhole pattern | |
| McKissock Breast Marker, 45mm, Keyhole pattern | |
| Mayo-Hegar Needle Holder, TC | |



Chin Augmentation Set (Walter Set), Consisting of;

- Scalpel Handle, #3 Standard
- Micro Iris Scissors, 9cm, Curved - Delicate
- Baby Metzenbaum T.C. Scissors, 11.5cm, Curved
- Metzenbaum T.C. Scissors, 14cm, Curved
- Collier Needle Holder, 13cm
- Neivert T.C. Needle Holder, 12.5cm, Smooth
- Halsted Mosquito Forceps, 12.5cm, Curved
- Joseph Skin Hook, Double Prong, Sharp, 16cm, 7mm Wide
- Walter Bone Elevator, 14.5cm, 8mm, Curved
- Walter Raspatory, 14.5cm, 8mm, Curved
- Walter Alar And Nasal Retractor With Fiber Optic Illumination, 18.5cm
- Aufricht Walter Nasal Retractor, 13.5cm, Double Ended, Sharp, 42x7mm
- Aufricht Walter Nasal Retractor, 13.5cm, Double Ended, Blunt, 38x7mm



Cleft & Palate Repairing Instruments Set,

Scalpel, Round Handle, 16cm
 Adson Forceps, 15cm, Serrated
 Adson Forceps, 15cm, 1x2 Teeth
 Iris Supercut Scissors, 11.5cm, Curved
 Iris Supercut Scissors, 11.5cm, Curved
 Ragnell Kilner Scissors, 13cm, Curved
 Supercut Plus Kelly T.C. Scissors, 16cm, Curved
 Metzenbaum T.C. Scissors, 18cm, Curved
 Crile Wood T.C. Needle Holder, 15cm
 Blocksma Cleft Palate Hook, 18cm, 3mm, 2 Prong
 Cleft Palate Raspatory, 14cm, #1 Left
 Cleft Palate Raspatory, 14cm, #2 Right
 Kahre Cleft Palate Raspatory, 17cm
 Mcindoe Cleft Palate Raspatory, 16.5cm

Muco-Periosteal Retractor, 19cm
 Wang Cleft Palate Elevator, 15.5cm
 Wang Cleft Palate Elevator, 18cm, Right
 Wang Cleft Palate Elevator, 18cm, Left
 Wang Cleft Palate Elevator, 18cm, Right Angled
 Wang Cleft Palate Elevator, 18cm, Left Angled
 Castroviejo Caliper, 7cm, 20mm Measuring Range
 Dingman Mouth Gag, Complete

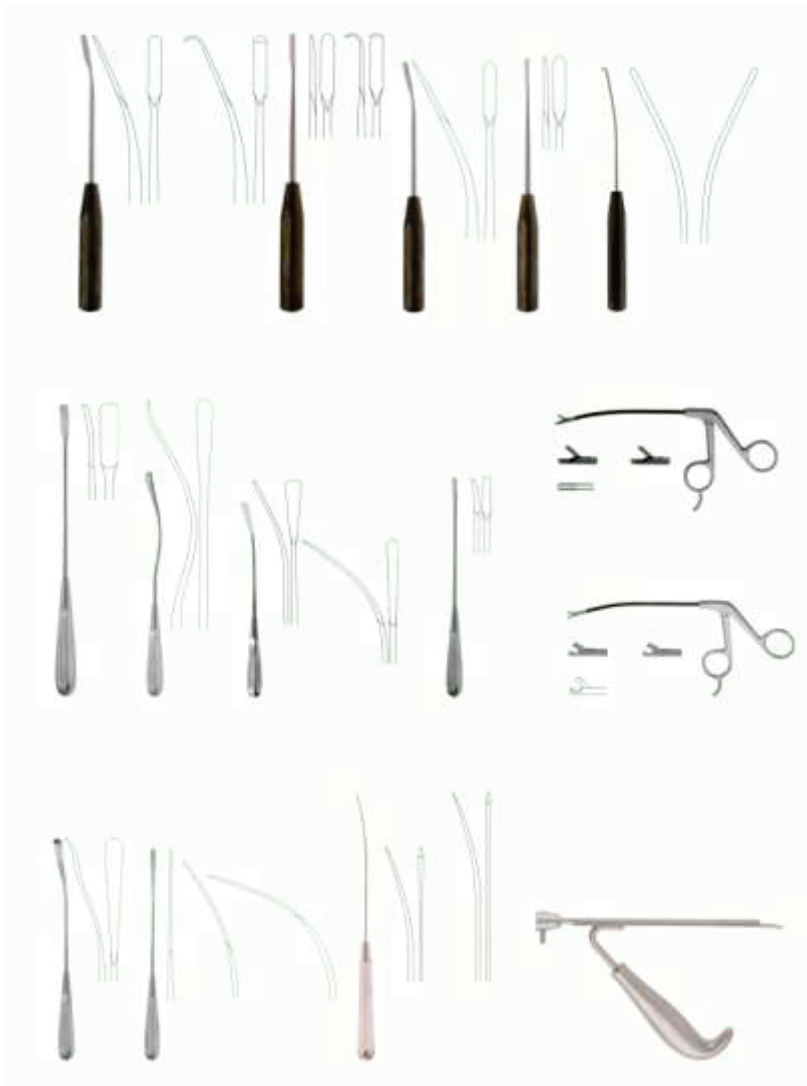

Endoscopic Face Lift Set, Consisting of;

- | | |
|--|---|
| Retractor With Channel For Endoscope, 20cm | Endo Facelift Dissector, 27.5cm, 11mm |
| Endo Facelift Raspatory, 25cm, 6mm, Straight | Endo Facelift Elevator, 27.5cm, 4mm |
| Endo Facelift Raspatory, 25cm, 6mm, Curved | Endo Facelift Dissector, 27.5cm, 9mm |
| Endo Facelift Raspatory, 25cm, 6mm, Straight | Endo Facelift Tissue Elevator, 27.5cm, 12mm, Slight Curve |
| Endo Facelift Raspatory, 25cm, 6mm, Curved | Endo Facelift Elevator, 25.5cm, 8mm, Half Curve |
| Endo Facelift Dissector, 25cm, 6mm, Blunt, Straight | Endo Facelift Elevator, 28cm, 8mm, Straight |
| Endo Facelift Dissector, 25cm, 6mm, Blunt, Curved | Endo Facelift Elevator, 27cm, 8mm, Slight Curve |
| Endo Facelift Nerve Hook, 20cm, Curved Left | Endo Facelift Elevator, 24cm, 8mm, Strong Curve |
| Endo Facelift Nerve Hook, 20cm, Curved Right | Endo Facelift Elevator With Suction, 27.5cm, 7mm |
| Hook Scissors, 12cm Working Length, Curved Left | |
| Hook Scissors, 12cm Working Length, Curved Right | |
| Grasping Forceps, 12cm Working Length, Curved Left | |
| Grasping Forceps, 12cm Working Length, Curved Right | |
| Endo Facelift Periosteal Elevator, 27cm, 9mm, S Curved | |



Face & Forehead Lift Set, Consisting of;

Scalpel Blades #15 - Sterile, 100/Box

Scalpel Handle, #7

Micro Adson Forceps, 12cm, 1x2 Teeth - 0.8mm Tips

Adson Brown Delicate Tissue Forceps, 12cm,

Select Tissue Forceps, 20cm, 1x2 Teeth - Extremely Fine

Gubisch T.C. Needle Holder, 12.5cm, Extra Fine

Baby Crile Wood T.C. Needle Holder, 15cm

Backhaus Towel Clamp, 8.5cm

Gillies Dura And Skin Retractor Hook, 19cm, Small

Joseph Delicate Retractor, 17cm, 2 Prong, 5mm, Sharp

Iris Supercut Scissors, 12.5cm, Curved

Supercut Mayo Scissors, 14cm, Straight

Gold Tip Supercut Scissors, 20cm, Curved, Slight Bevel On Shank

Gold Tip Supercut Scissors, 20cm, Curved, Strong Bevel On Shank

Farabeuf Baby Retractors, 12cm,

Walter Retractor, 19cm, 4 Prongs,

Langenbeck Kocher Retractor #13, 15 X 80mm

Solz Racket Retractor, 12.5cm, 45x100mm

Pitanguy Facelift Marker, 16cm, 5mm Wide



Forehead Lift and Facial Implant Set Detail :

Siegel Knife Handle
 Flexible Ruler
 Halsted Mosquito Forceps, curved
 Adson Hemostatic Forceps, curved
 Allis Tissue Forceps, 4 x 5 teeth
 Frazier Suction Tube, 10 FR
 Yankauer Suction Tube
 Gorney Freeman Scissors, SC, curved
 Metzenbaum, straight
 Iris Scissors, TC, straight
 Adson Dressing Forceps, serrated
 Adson Tissue & Suture Forceps, 1 x 2 teeth
 Brown-Adson Forceps, 9 x 9 teeth
 Bayonet Bipolar Forceps, 1.0 mm tips
 Cushing Tissue Forceps, Bayonet, 1 x 2 teeth
 Mayo-Hegar Needle Holder, TC
 Crile-Wood Needle Holder, TC, smooth jaws
 Joseph Double Hook, sharp

Gillies Skin Hook
 US Army Retractor, 2/set
 University of Minnesota Cheek Retractor
 D'Assumpcao Face Lift Marker
 Ferreira Fiber Optic Retractor
 Aufricht Fiber Optic Retractor
 Deaver Fiber Optic Retractor, 5/8"
 Deaver Fiber Optic Retractor, 1"
 #9 Molt Elevator
 Tessier Periosteal Elevator, 6 mm Wide
 Tessier Periosteal Elevator, 7 mm Wide
 Tessier Periosteal Elevator, 9 mm Wide
 Scalp Elevator Dissector, curved, 7 mm
 Frontotemporal Dissector, curved, 7 mm
 Frontotemporal Dissector, straight, 10 mm
 Corrugator and Procerus Muscle Dissector,
 S-shaped, 5 mm



RHINOPLASTY INSTRUMENTS

Aiach-Gubisch cartilage forceps 16CM
 COTTLE GUBISCH CHISEL, 18CM, 5MM, GRADUATED, HOLLOW CUT
 GUBISCH FANOUS NASAL OSTEOTOME, 19.5CM, NARROW, DELICATE, WITH GUIDE THORN
 GUBISCH AUFRICHT NASAL RETRACTOR, 17CM, 50X6-12MM
 GUBISCH CARTILAGE CRUSHER, 65X30MM
 GUBISCH FOMON T.C. NASAL RASP, 20CM
 GUBISCH KILNER DOUBLE NASAL HOOK (ALAR RETRACTOR), 8CM, SHARP, 5X10MM
 GUBISCH OSTEOTOME, 18.5CM, 3MM, ALUMINIUM HANDLE
 SUCTION RASPATORY WITH GUIDE, 20CM, 4MM
 GUBISCH T.C. NEEDLE HOLDER, 12.5CM, EXTRA FINE
 Gubisch-Rubin Tungsten Carbide septal morseliser forceps



MAMMAPLASTY SET

- Scalpel Blades #15 - Sterile, 100/Box
- Scalpel Handle, #7
- Jabeley Scissors, 13cm, Curved - Sharp/Sharp
- Metzenbaum Scissors, 20cm, Curved - Standard Pattern
- Micro Adson Forceps, 12cm, 1x2 Teeth - 0.8mm Tips
- Gruenwald Nasal Bayonet Forceps, 19.5cm, Serrated Tips
- Baby Crile Wood Needle Holder, 15cm
- Baby Crile Wood T.C. Needle Holder, 15cm
- Jabeley Supercut Scissors, 13cm, Curved - Sharp/Sharp
- "Gold Tip" Supercut Scissors, 20cm, Curved, Slight Bevel On Shank
- Solz "Gold Tip" Supercut Scissors, 20cm, Curved, Strong Bevel On Shank
- Farabeuf Baby Retractors, 12cm, Double Ended, Set Of 2
- Langenbeck Kocher Retractor #13, 15mm Wide X 80mm Deep, 21cm
- Atraumatic Breast Dissector, 34cm
- Breast Hook Dissector, Curved to Left 36cm
- Breast Hook Dissector, Curved to Right 36cm
- Areola Marker, Blunt, 36mm Diameter
- Areola Marker, Blunt, 40mm Diameter
- Areola Marker, Blunt, 42mm Diameter
- Areola Marker, Blunt, 45mm Diameter
- Marx Breast Retractor, 27cm, 125 X 30mm
- Round Bowl For Solutions/Marking Color, 60x30mm, 60cc

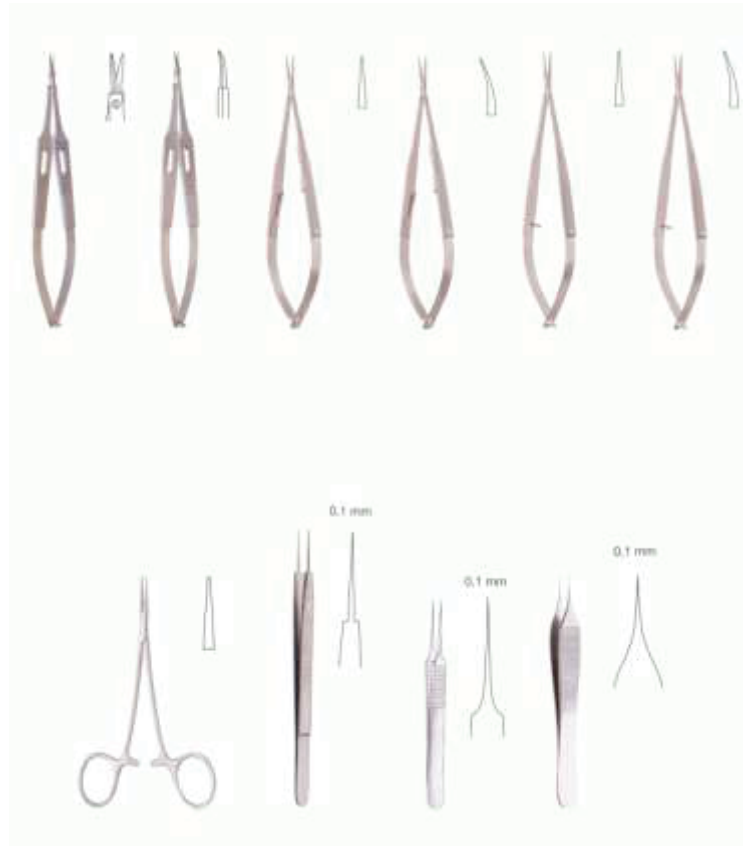

Micro Surgical Instruments Set, Consisting of;

- Micro Vannas Scissors, 15cm, Curved, Ultra Fine
- Micro Vannas Scissors, 15cm, Straight, Ultra Fine
- Ultra Fine Micro Forceps, 11cm
- Ultra Fine Micro Forceps, 14cm
- Jacobson Adson Koshima Ultra Fine Forceps, 12cm
- Castroviejo Ultra Fine Needle Holder, 14.5cm, Straight
- Castroviejo Ultra Fine Needle Holder, 14.5cm, Curved
- Castroviejo Ultra Fine Needle Holder, 14.5cm, Straight
- Castroviejo Ultra Fine Needle Holder, 14.5cm, Curved
- Jacobson Micro Mosquito Forceps, 12.5cm, Straight

RhinoPlasty Instruments Set (Walter Set), Consisting of;

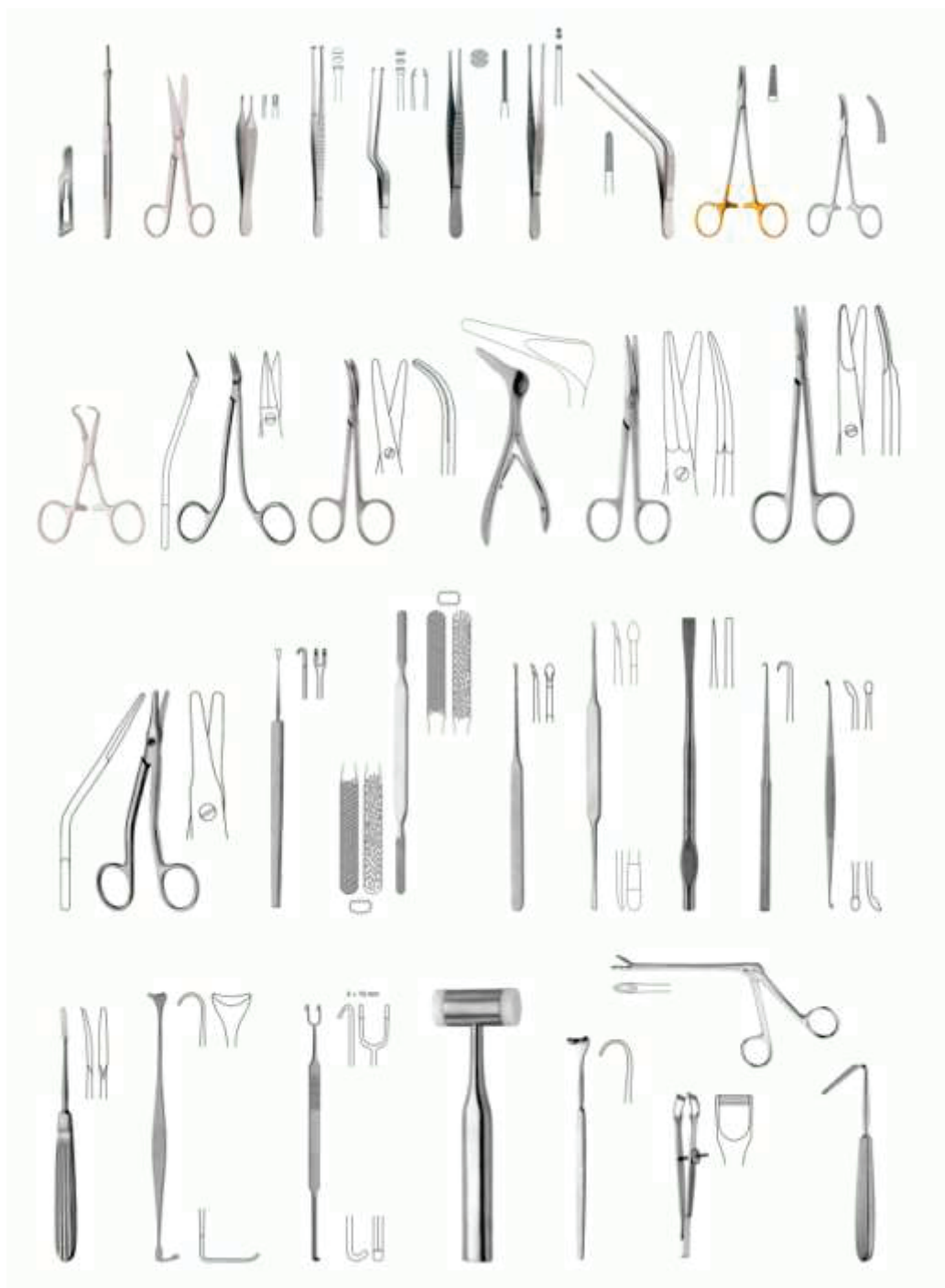

RhinoPlasty Instruments Set (Walter Set), Consisting of;

Scalpel Handle, #7k,
 Surgical Operating Scissors, 14.5cm, Curved - Sharp/Blunt
 Ragnell Kilner Scissors, 15cm, Curved - Flattened At Distal End
 Fox T.C. Gum And Tissue Scissors, 13cm, Curved, 1 Serrated Blade
 Adson Brown Delicate Tissue Forceps, 12cm, 7x7 Teeth, Straight
 Adson Brown Delicate Tissue Forceps, 12cm, 9x9 Teeth, Straight
 Semken Delicate Tissue Forceps, 12.5cm, 2x3 Teeth, Straight
 Debakey At Vascular Forceps, 15cm - 1.5mm Tips
 Bayonet Grasping Forceps, 16cm
 Bayonet Grasping Forceps, 16cm, 1x1 Teeth
 Troeltsch Wilde Angular Forceps, 13cm, Adult Size - Serrated
 Grooved Director And Tongue Tie, 11.5cm
 Frazier Fergusson Suction Tube, 18cm, Angled, 10 French e
 Senning T.C. Needle Holder, 17cm, Serrated
 Halsted Micro Mosquito Forceps, 12.5cm, Curved
 Backhaus Towel Clamp, 8.5cm
 Gross Dressing Forceps, 20cm, Straight - Without Catch, Box Lock
 Walter Cope Retractor, 17.5cm
 Joseph Skin Hook, 16cm, Single Prong, Sharp
 Guthrie Double Retractor Hook, 13cm, 2mm Wide, Sharp
 Lempert Raspatory, 17cm, 4mm, Delicate, Sharp
 Supercut Walter Dorsal Scissors, 14cm, Angular
 Supercut Walter Cottle Dorsal Scissors, 16cm, Curved
 Medicon Mallet, 18.5cm, Plastic Facings, 200 Grams, 25mm Diameter
 Walter Williger Bone Curette, 13.5cm, 2/2mm, Double Ended, Sharp, Angled
 Defourmentel Bone Rongeur, 19cm, Straight, Slender Beaks - Jaws 3mm Wide
 Weil Blakesley Wilde Ethmoid Bone Forceps #3, 120mm Shaft, 4.2mm
 Weil Blakesley Wilde Ethmoid Bone Forceps #2, 45 Degree Angle, 120mm Shaft, 3.6mm
 Myles Nasal Through Cutting Forceps #4, 120mm Shaft
 Cottle Nasal Septum Speculum, 14cm, 50mm
 Cottle Elevator, 16cm, 2.5mm
 Masing Septum Elevator, 22cm, 5/5mm, Double Ended
 Aufricht Walter Nasal Retractor, 13.5cm, Double Ended, Sharp, 42x7mm
 Aufricht Walter Nasal Retractor, 13.5cm, Double Ended, Blunt, 38x7mm
 Walter Chisel/Osteotome, 19cm, 3mm, Modified
 Walter Chisel/Osteotome, 19cm, 5mm, Modified
 Walter Osteotome, 19cm, 2mm, Straight
 Walter Osteotome, 19cm, 12mm, Straight
 Walter Chisel/Osteotome, 19cm, 12mm, Modified
 Walter Osteotome, 19cm, 6mm, Curved
 Walter Cantanares Lifting Scissors, 16cm, Curved
 Fomon Rhinoplasty Scissors, 12.5cm
 Cottle Columella Forceps, 11cm
 Fomon Bone And Nasal Rasp, 20cm
 Asch Septum Straightening Forceps, 22cm, Angled
 Brunings Tongue Depressor, 19cm, 14mm

RHINOPLASTY INSTRUMENTS SET (Gubisch Set), Consisting of;



RHINOPLASTY INSTRUMENTS SET (Gubisch Set), Consisting of;

Scalpel Blades #15 - Sterile,
 Scalpel Handle, #7
 Surgical Operating Scissors, 13cm, Straight - Sharp/Blunt
 Mayo Stille T.C. Operating Scissors, 17cm, Curved
 Reynolds Jameson Scissors, 14cm, Curved - With Fine, Rounded Points
 Adson T.C. Tissue Forceps, 12cm
 Micro Adson Forceps, 12cm, 1x2 Teeth - 0.8mm Tips
 Adson Brown Delicate Tissue Forceps, 12cm, 7x7 Teeth, Straight - Atraumatic
 Dressing Forceps, 20cm - Modified Swedish Pattern
 Nelson Tissue Forceps, 15cm
 Gruenwald Jansen Nasal Dressing Bayonet Forceps, 16cm, Serrated
 Gubisch T.C. Needle Holder, 12.5cm, Extra Fine
 Crile Wood T.C. Needle Holder, 15cm
 Halsted Micro Mosquito Forceps, 12.5cm, Curved
 Leriche Artery Forceps, 15cm, 1x2 Teeth, Straight
 Pean Hemostatic Forceps, 14cm, Straight
 Backhaus Towel Clamp, 13cm
 Dressing Forceps, 17.5cm, Curved, Delicate
 Gross Dressing Forceps, 20cm, Curved - With Catch, Box Lock
 Barsky Skin Hook, 15cm, Single Prong, Sharp
 Joseph Delicate Retractor, 17cm, 2 Prong, 5mm, Sharp
 Guthrie Double Retractor Hook, 13cm, Sharp
 Supercut Plus T.C. Mayo Scissors, 14cm, Straight
 Supercut Plus T.C. Mayo Scissors, 17cm, Curved
 Supercut Plus Metzenbaum T.C. Scissors, 18cm, Curved
 Supercut Plus Kelly T.C. Scissors, 16cm, Curved
 Langenbeck Bone Elevator, 20cm, 7mm, Blunt
 Freer Raspatory, 19cm, 5/5mm, Double Ended, Sharp / Sharp
 Williger Raspatory, 16cm, 5mm, Sharp
 Mckenty Raspatory, 15cm, 4mm, Sharp, Light Curve
 Supercut Heymann Nasal Scissors, 18cm
 Supercut Plus Fomon T.C. Dorsal Scissors, 13cm, Angular
 Mallet, 26cm, Novotex Plastic, 240 Grams, 45mm Diameter
 Round Bowl For Solutions, 40x20mm, 20cc
 Round Bowl For Solutions/Marking Color, 60x30mm, 60cc
 Round Bowl For Solutions, 80x40mm, 160cc
 Round Bowl For Solutions, 110x55mm, 400cc
 Castroviejo Caliper, 7cm, 20mm Measuring Range
 Desmarres Lid Retractor #2, 14cm, Medium, 10x14mm
 Killian Asept Nasal Speculum, #4, 90mm (Modified)
 Weil Blakesley Wilde Ethmoid Bone Forceps #3, 120mm Shaft, 4.2mm
 Freer Septum Knife (Mucosa Scalpel), 16cm
 Cottle Nasal Speculum, Delicate, 15cm, 55mm
 Gubisch Suction Raspatory With Guide And Bypass Hole, 20cm, 4mm
 Gubisch Suction Raspatory With Guide, 17cm, 4mm
 Cartilage Cutting Block, Teflon, 85x55x10mm
 Gubisch Cartilage Crusher, 65x30mm
 Gubisch Kilner Double Nasal Hook (Alar Retractor), 8cm, Sharp, 5x10mm
 Gubisch Aufricht Nasal Retractor, 17cm, 50x6-12mm
 Cottle Gubisch Chisel, 18cm, 5mm, Graduated, Hollow Cut
 Cottle Gubisch Chisel, 18cm, 12mm, Graduated, Hollow Cut
 Gubisch Osteotome, 18.5cm, 3mm, Aluminium Handle
 Fanous Osteotome, 19.5cm, 4mm, Straight, With Guide Thorn - 1)
 Caplan Nasal Septum Scissors, 20cm, Serrated
 Gubisch Fomon T.C. Nasal Rasp, 20cm
 Rubin T.C. Septal Morselizer Forceps, 20cm, With Protective Guard
 Buchwald Tongue Spatula, 18cm, 18x23mm

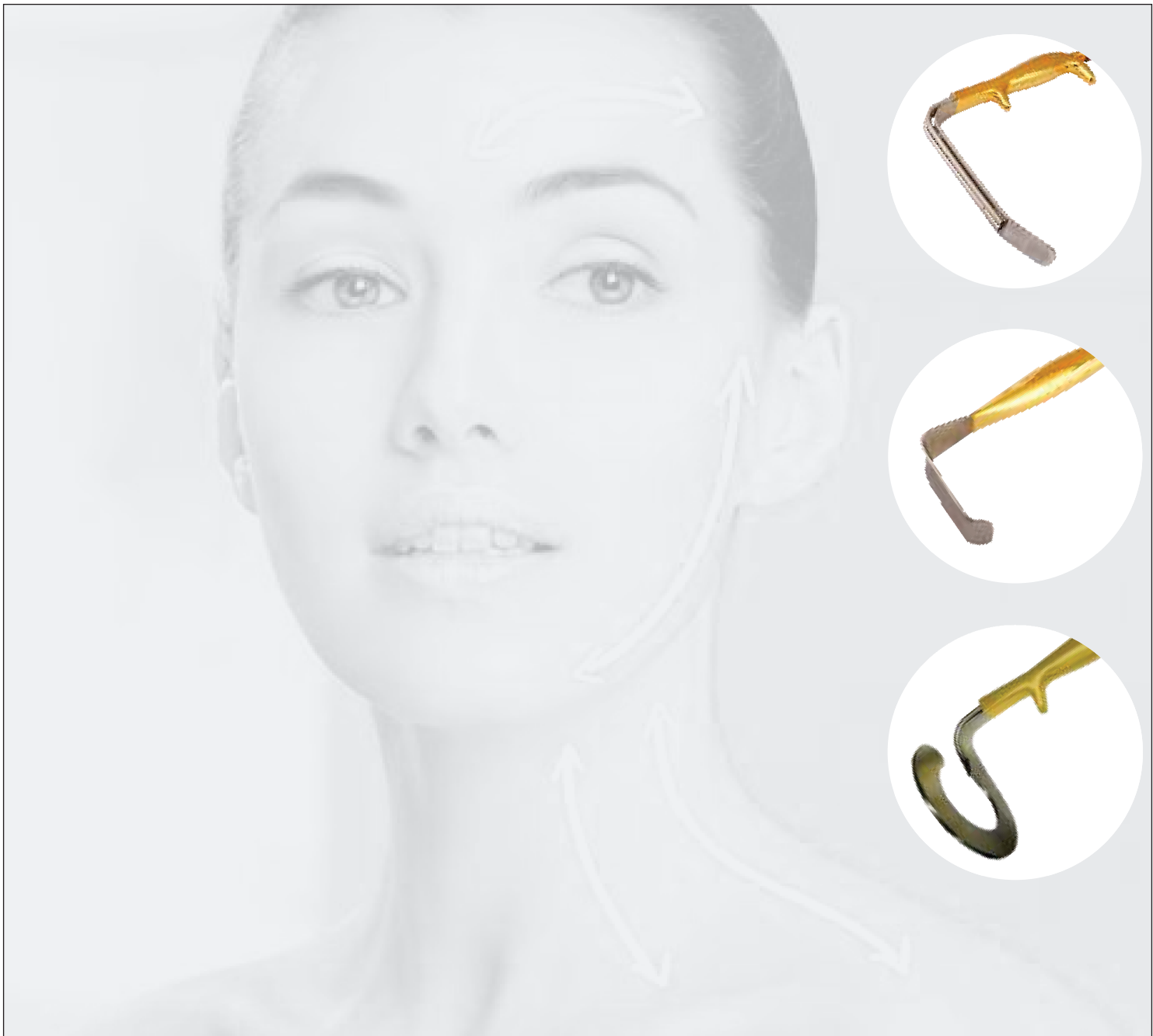

FRIZKON
INTERNATIONAL

Pakistan Address:

Address:
No 665 Naaz Street KLW Sialkot 51310

Email:
info@frizkontools.com

Contact:
+923314494637
+923325334864
+0523306091

Website:
www.frizkontools.com

USA Address:

Address:
13626 Near Point Tomball TX77377

Email:
info@frizkontools.com

Contact:
+1 (832) 686-3125

Website:
www.frizkontools.com

Ireland Address:

Address:
35 Belmont Middle Gardiner Street
Dublin D01C447

Email:
info@frizkontools.com

Contact:
+353831052805

Website:
www.frizkontools.com